



中国认可  
国际互认  
检测  
TESTING  
CNAS L0220

Test Report issued under the responsibility of:



Total Quality. Assured.

<b>REPORT</b> <b>VDE-AR-N 4105:2018-11</b> <b>Generators connected to the low-voltage distribution network –</b> <b>Technical requirements for the connection to and parallel operation with</b> <b>low-voltage distribution networks in junction with</b> <b>DIN VDE V 0124-100 :2020-06</b>	
Report Reference No.....	190430040GZU-001
Date of issue.....	24 Jun 2020
Total number of pages.....	219 pages
<b>Testing Laboratory</b> .....	Intertek Testing Services Shenzhen Ltd. Guangzhou Branch
Address.....	Room 02, & 101/E201/E301/E401/E501/E601/E701/E801 of Room 01 1-8/F., No. 7-2. Caipin Road, Science City, GETDD, Guangzhou, Guangdong, China
Testing location/ address.....	Same as above
Tested by (name + signature).....	Sunny Lin Engineer
Approved by (+ signature).....	Jason Fu Technical Team Leader
<b>Applicant's name</b> .....	Shenzhen SOFAR SOLAR Co., Ltd.
Address.....	401, Building 4, AnTongDa Industrial Park, District 68, XingDong Community, XinAn Street, BaoAn District, Shenzhen, China
<b>Test specification:</b>	
Standard .....	VDE-AR-N 4105:2018-11 DIN VDE V 0124-100 :2020-06
Test procedure.....	Type approval
Non-standard test method.....	N/A
<b>Test Report Form No.</b> .....	VDE-AR-N 4105d
Test Report Form(s) Originator .....	Intertek Guangzhou
Master TRF .....	Dated 2020-06
<p>This publication may be reproduced in whole or in part for non-commercial purposes as long as Intertek is acknowledged as copyright owner and source of the material. Intertek takes no responsibility for and will not assume liability for damages resulting from the reader's interpretation of the reproduced material due to its placement and context.</p>	
<b>Test item description</b> .....	Solar Grid-tied Inverter
Trade Mark.....	
Manufacturer.....	Same as Applicant

Model/Type reference.....: SOFAR 20000TL-G2, SOFAR 25000TL-G2, SOFAR 30000TL-G2, SOFAR 33000TL-G2					
Ratings.....:	Model	SOFAR 20000TL- G2	SOFAR 25000TL- G2	SOFAR 30000TL- G2	SOFAR 33000TL- G2
	Max. DC input Voltage	1100Vdc			
	Operating MPPT voltage range	230Vdc – 960Vdc			
	PV Isc	30A*2	35A*2	37.5A*2	37.5A*2
	Max.output current	3*32A	3*40A	3*48A	3*53A
	Max.Output Power	22000VA	27500VA	33000VA	36300VA
	Nominal output voltage	3W/N/PE 230Vac/400Vac			
	Nominal output Frequency	50Hz			
	Power factor range	0.8Leading – 0.8 lagging			
	Safety level	Class I			
	Ingress Protection	IP 65			
	Operation Ambient Temperature	-25°C - +60°C			
	Software version	V2.30			

<b>Summary of testing:</b>																																			
<p><b>Tests performed (name of test and test clause):</b></p> <table border="1"> <thead> <tr> <th>VDE4105 (VDE0124)</th> <th>Test Description</th> </tr> </thead> <tbody> <tr> <td><b>5.4.4.1 (5.2.2)</b></td> <td>Rapid voltage changes</td> </tr> <tr> <td><b>5.4.4.2 (5.2.3)</b></td> <td>Flicker</td> </tr> <tr> <td><b>5.4.4.3 (5.2.4)</b></td> <td>Harmonics and inter-harmonics</td> </tr> <tr> <td><b>5.4.4.4 (5.2.5)</b></td> <td>Commutation notches</td> </tr> <tr> <td><b>5.4.4.8 (5.2.6)</b></td> <td>DC current feeding to network</td> </tr> <tr> <td><b>5.6 (5.3)</b></td> <td>Asymmetry calculation for three-phase inverter</td> </tr> <tr> <td><b>5.7.2.2.2 (5.4.2)</b></td> <td>Measurement of active- and reactive power ranges</td> </tr> <tr> <td><b>5.7.2.3 (5.4.8.1)</b></td> <td>Reactive power provision below PEmax</td> </tr> <tr> <td><b>5.7.2.4 (5.4.8.2 &amp; 5.4.8.3)</b></td> <td>Method of reactive power provision</td> </tr> <tr> <td><b>5.7.3 (5.8)</b></td> <td>Dynamic Network support</td> </tr> <tr> <td><b>5.7.4.2 (5.4.3)</b></td> <td>Network security management</td> </tr> <tr> <td><b>5.7.4.3 (5.4.4 &amp; 5.4.5 &amp; 5.4.6 &amp; 5.4.7)</b></td> <td>Active power adjustment when over- and under frequency</td> </tr> <tr> <td><b>6.4 (5.5.1 &amp; 5.5.2 &amp; 5.5.3 &amp; 5.5.4 &amp; 5.5.5 &amp; 5.5.6)</b></td> <td>Interface switch (Functional safety)</td> </tr> <tr> <td><b>6.5.2 (5.5.7 &amp; 5.5.8 &amp; 5.5.9)</b></td> <td>Protective function</td> </tr> <tr> <td><b>6.5.3 (5.5.10)</b></td> <td>Islanding detection</td> </tr> <tr> <td><b>8.3 (5.6)</b></td> <td>Connection conditions and synchronisation</td> </tr> </tbody> </table>	VDE4105 (VDE0124)	Test Description	<b>5.4.4.1 (5.2.2)</b>	Rapid voltage changes	<b>5.4.4.2 (5.2.3)</b>	Flicker	<b>5.4.4.3 (5.2.4)</b>	Harmonics and inter-harmonics	<b>5.4.4.4 (5.2.5)</b>	Commutation notches	<b>5.4.4.8 (5.2.6)</b>	DC current feeding to network	<b>5.6 (5.3)</b>	Asymmetry calculation for three-phase inverter	<b>5.7.2.2.2 (5.4.2)</b>	Measurement of active- and reactive power ranges	<b>5.7.2.3 (5.4.8.1)</b>	Reactive power provision below PEmax	<b>5.7.2.4 (5.4.8.2 &amp; 5.4.8.3)</b>	Method of reactive power provision	<b>5.7.3 (5.8)</b>	Dynamic Network support	<b>5.7.4.2 (5.4.3)</b>	Network security management	<b>5.7.4.3 (5.4.4 &amp; 5.4.5 &amp; 5.4.6 &amp; 5.4.7)</b>	Active power adjustment when over- and under frequency	<b>6.4 (5.5.1 &amp; 5.5.2 &amp; 5.5.3 &amp; 5.5.4 &amp; 5.5.5 &amp; 5.5.6)</b>	Interface switch (Functional safety)	<b>6.5.2 (5.5.7 &amp; 5.5.8 &amp; 5.5.9)</b>	Protective function	<b>6.5.3 (5.5.10)</b>	Islanding detection	<b>8.3 (5.6)</b>	Connection conditions and synchronisation	<p><b>Testing location:</b></p> <p>Intertek Testing Services Shenzhen Ltd. Guangzhou Branch</p> <p>Block E, No.7-2 Guang Dong Software Science Park, Caipin Road, Guangzhou Science City, GETDD, Guangzhou, China</p>
VDE4105 (VDE0124)	Test Description																																		
<b>5.4.4.1 (5.2.2)</b>	Rapid voltage changes																																		
<b>5.4.4.2 (5.2.3)</b>	Flicker																																		
<b>5.4.4.3 (5.2.4)</b>	Harmonics and inter-harmonics																																		
<b>5.4.4.4 (5.2.5)</b>	Commutation notches																																		
<b>5.4.4.8 (5.2.6)</b>	DC current feeding to network																																		
<b>5.6 (5.3)</b>	Asymmetry calculation for three-phase inverter																																		
<b>5.7.2.2.2 (5.4.2)</b>	Measurement of active- and reactive power ranges																																		
<b>5.7.2.3 (5.4.8.1)</b>	Reactive power provision below PEmax																																		
<b>5.7.2.4 (5.4.8.2 &amp; 5.4.8.3)</b>	Method of reactive power provision																																		
<b>5.7.3 (5.8)</b>	Dynamic Network support																																		
<b>5.7.4.2 (5.4.3)</b>	Network security management																																		
<b>5.7.4.3 (5.4.4 &amp; 5.4.5 &amp; 5.4.6 &amp; 5.4.7)</b>	Active power adjustment when over- and under frequency																																		
<b>6.4 (5.5.1 &amp; 5.5.2 &amp; 5.5.3 &amp; 5.5.4 &amp; 5.5.5 &amp; 5.5.6)</b>	Interface switch (Functional safety)																																		
<b>6.5.2 (5.5.7 &amp; 5.5.8 &amp; 5.5.9)</b>	Protective function																																		
<b>6.5.3 (5.5.10)</b>	Islanding detection																																		
<b>8.3 (5.6)</b>	Connection conditions and synchronisation																																		
<p>Remark:</p> <p>Other than special notice, the model SOFAR 33000TL-G2 is type tested and valid for other models</p> <p>For clause 6.4, 6.5.2 &amp; 6.5.3 are performed on model SOFAR 25000TL-G2 for integrated protection, and valid for model SOFAR 20000TL-G2</p>																																			

**Copy of marking plate**

**SOFAR SOLAR** Solar Grid-tied Inverter

Model No:	SOFAR 20000TL-G2
Max. DC Input Voltage	1100V
Operating MPPT Voltage Range	230~960V
Max. Input Current	24A/24A
Max. PV Isc	30A/30A
Nominal Grid Voltage	3/N/PE,400Vac
Max. Output Current	3x32A
Nominal Grid Frequency	50/60Hz
Nominal Output Power	20000W
Max. Output Power	22000VA
Power Factor	>0.99(adjustable+/-0.8)
Ingress Protection	IP65
Operating Temperature Range	-25°C~+60°C
Protective Class	Class I
Made in China	
Manufacturer : Shenzhen SOFAR SOLAR Co.,Ltd. Address : 401, Building 4, AnTongDa Industrial Park, District 68, XingDong Community,XinAn Street, BaoAn District, Shenzhen, China VDE0126-1-1,VDE-AR-N4105,G99,IEC61727 IEC62116,UTE C15-712-1,AS4777	

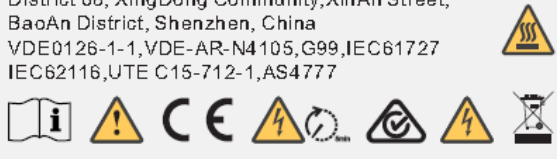

**SOFAR SOLAR** Solar Grid-tied Inverter

Model No:	SOFAR 25000TL-G2
Max. DC Input Voltage	1100V
Operating MPPT Voltage Range	230~960V
Max. Input Current	28A/28A
Max. PV Isc	35A/35A
Nominal Grid Voltage	3/N/PE,400Vac
Max. Output Current	3x40A
Nominal Grid Frequency	50/60Hz
Nominal Output Power	25000W
Max. Output Power	27500VA
Power Factor	>0.99(adjustable+/-0.8)
Ingress Protection	IP65
Operating Temperature Range	-25°C~+60°C
Protective Class	Class I
Made in China	
Manufacturer : Shenzhen SOFAR SOLAR Co.,Ltd. Address : 401, Building 4, AnTongDa Industrial Park, District 68, XingDong Community,XinAn Street, BaoAn District, Shenzhen, China VDE0126-1-1,VDE-AR-N4105,G99,IEC61727 IEC62116,UTE C15-712-1,AS4777	



**SOFAR SOLAR** Solar Grid-tied Inverter

Model No:	SOFAR 30000TL-G2
Max. DC Input Voltage	1100V
Operating MPPT Voltage Range	230~960V
Max. Input Current	30A/30A
Max. PV Isc	37.5A/37.5A
Nominal Grid Voltage	3/N/PE,400Vac
Max. Output Current	3x48A
Nominal Grid Frequency	50/60Hz
Nominal Output Power	30000W
Max. Output Power	33000VA
Power Factor	>0.99(adjustable+/-0.8)
Ingress Protection	IP65
Operating Temperature Range	-25°C~+60°C
Protective Class	Class I
Made in China	

Manufacturer: Shenzhen SOFAR SOLAR Co., Ltd.  
 Address: 401, Building 4, AnTangDa Industrial Park,  
 District 168, XingDong Community, XinAn 5 Street,  
 BaoAn District, Shenzhen, China  
 VDE0126-1-1, VDE-AR-N4105, G99, IEC61727  
 IEC62116, LITE C15-712-1, A54777



**SOFAR SOLAR** Solar Grid-tied Inverter

Model No:	SOFAR 33000TL-G2
Max. DC Input Voltage	1100V
Operating MPPT Voltage Range	230~960V
Max. Input Current	30A/30A
Max. PV Isc	37.5A/37.5A
Nominal Grid Voltage	3/N/PE,400Vac
Max. Output Current	3x53A
Nominal Grid Frequency	50/60Hz
Nominal Output Power	33000W
Max. Output Power	36300VA
Power Factor	>0.99(adjustable+/-0.8)
Ingress Protection	IP65
Operating Temperature Range	-25°C~+60°C
Protective Class	Class I
Made in China	

Manufacturer: Shenzhen SOFAR SOLAR Co., Ltd.  
 Address: 401, Building 4, AnTangDa Industrial Park,  
 District 168, XingDong Community, XinAn 5 Street,  
 BaoAn District, Shenzhen, China  
 VDE0126-1-1, VDE-AR-N4105, G99, IEC61727  
 IEC62116, LITE C15-712-1, A54777



**Note:**

1. The above markings are the minimum requirements required by the safety standard. For the final production samples, the additional markings which do not give rise to misunderstanding may be added.
2. Label is attached on the side surface of enclosure and visible after installation.

<b>Test item particulars</b> .....:	
Temperature range .....	
AC Overvoltage category.....:	<input type="checkbox"/> OVC I <input type="checkbox"/> OVC II <input checked="" type="checkbox"/> OVC III <input type="checkbox"/> OVC IV
DC Overvoltage category .....	<input type="checkbox"/> OVC I <input checked="" type="checkbox"/> OVC II <input type="checkbox"/> OVC III <input type="checkbox"/> OVC IV
IP protection class .....	
<b>Possible test case verdicts:</b>	
- test case does not apply to the test object.....: N/A (Not applicable)	
- test object does meet the requirement .....	
- test object does not meet the requirement .....	
<b>Testing</b> .....:	
Date of receipt of test item.....:	09 Mar 2020
Date (s) of performance of tests.....:	09 Mar 2020 – 10 Jun 2020
<b>General remarks:</b>	
<p>The test results presented in this report relate only to the object tested.          This report shall not be reproduced, except in full, without the written approval of the Issuing testing laboratory.          "(see Enclosure #)" refers to additional information appended to the report.          "(see appended table)" refers to a table appended to the report.</p> <p>When determining for test conclusion, measurement uncertainty of tests has been considered.          This report is for the exclusive use of Intertek's Client and is provided pursuant to the agreement between Intertek and its Client. Intertek's responsibility and liability are limited to the terms and conditions of the agreement. Intertek assumes no liability to any party, other than to the Client in accordance with the agreement, for any loss, expense or damage occasioned by the use of this report. Only the Client is authorized to permit copying or distribution of this report and then only in its entirety. Any use of the Intertek name or one of its marks for the sale or advertisement of the tested material, product or service must first be approved in writing by Intertek. The observations and test results in this report are relevant only to the sample tested. This report by itself does not imply that the material, product, or service is or has ever been under an Intertek certification program.          The test report only allows to be revised only within the report defined retention period unless standard or regulation was withdrawn or invalid.</p> <p>Throughout this report a point is used as the decimal separator.</p>	

**General product information:**

The Solar converter is a three-phase type. The unit is providing EMC filtering at the output toward mains. The unit does not provide galvanic separation from input to output (transformerless). The output is switched off redundant by the high power switching bridge and two relays. This assures that the opening of the output circuit will also operate in case of one error.

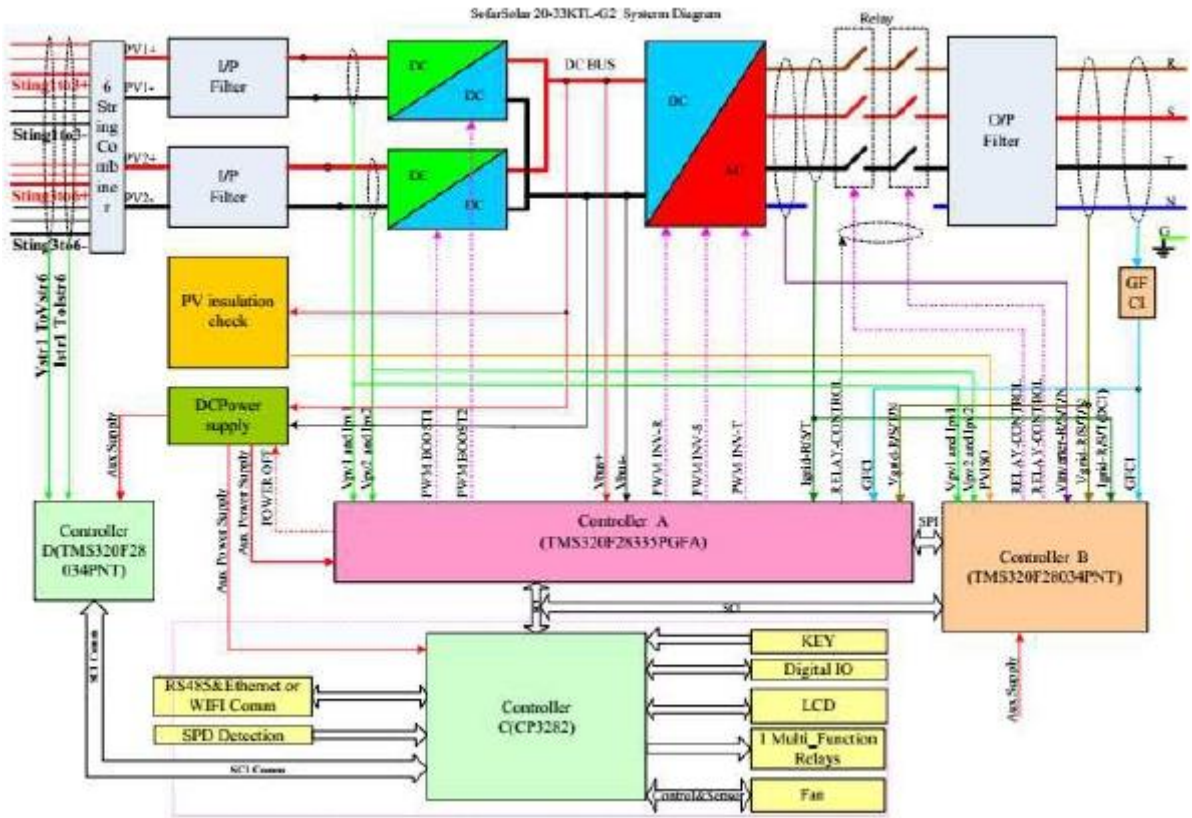

The internal control is redundant built. It consists of Main DSP(UC20) and slave DSP(UC73). The Main DSP(UC20) can control the relays, measures voltage, and frequency, AC current with injected DC, insulation resistance and residual current, In addition it tests the array insulation resistance and the RCMU circuit before each start up. The slave DSP(UC73) is using for detecting residual current, also can open the relays independently and communicate with Main DSP(UC20). The unit provides two relays in series on Line conductors. When single-fault applied to one relay, alarm an error code in display panel, another redundant relay provides basic insulation maintained between the PV array and the mains. All the relays are tested before starting up. Both controllers (Main DSP(UC20), Slave DSP(UC73) can open the relays

**Model differences:**

The models SOFAR 20000TL-G2, SOFAR 25000TL-G2, SOFAR 30000TL-G2 and SOFAR 33000TL-G2 are almost identical in hardware except the shown in the following table and the output power derated by software.

The difference in hardware			
Item	SOFAR 20000TL-G2	SOFAR 25000TL-G2	SOFAR 30000TL-G2 / SOFAR 33000TL-G2
Number of PV terminal	2+2		3+3
Number of BUS capacitance	8 capacitors: 550V/110 $\mu$ F 2 capacitors: 1100V/40 $\mu$ F		10 capacitors: 550V/110 $\mu$ F 4 capacitors: 1100V/40 $\mu$ F
INV inductance	785 $\mu$ H		735 $\mu$ H
Combiner board	Not the board		Have the board
External fan	Not the board	2	3
Relay of output board	6pcs T9VV1K15-12S		3pcs AZSR250-2AE-12D

**Factory information:**

Dongguan SOFAR SOLAR Co., Ltd.

1F-6F, Building E, No.1 JinQi Road, Bihu Industrial Park, Wulian Village, Fenggang Town, Dongguan City,China



VDE-AR-N 4105:2018-11			
Clause	Requirement - Test	Result - Remark	Verdict

<b>4</b>	<b>General framework conditions</b>		N/A
4.1	<b>Provisions and regulations</b>	This report is only evaluated and tested for PGU; The PGS incorporated with the PGU shall further consider this clause and sub-clause.	N/A
4.2	<b>Application procedure and relevant document for connection</b>	Shall consider in final PGS	N/A
4.3	<b>Commissioning of the power generation system and/or the storage unit</b>	Shall consider in final PGS	N/A

<b>5</b>	<b>Network connection</b>		<b>P</b>
5.1	<p><b>Principles for determination of the network connection point</b></p> <p>Power generation systems and storage units shall be connected at a suitable point of the network, i. e. the network connection point. Based on the documents listed in 4.2, the network operator determines the suitable network connection point which will ensure safe network operation while also taking into account the power generation system and the storage unit and at which the requested power can be drawn and transmitted. The essential aspect for a network connection evaluation is always the behaviour of the power generation system and the storage unit at the network connection point or at the PCC. This is intended to ensure that the power generation system or storage unit is operated without adverse interactions and impairment of the supply of other customers. Annex D shows an example of the connection evaluation of power generation systems..</p>	Shall consider in final PGS	N/A
5.2	<p><b>Rating of the network equipment</b></p> <p>Due to their operating mode, power generation systems and storage units may cause higher loading of lines, transformers and other network equipment. Therefore, the network operator verifies the transmission capacity of the network equipment with regard to the connected power generation systems and storage units in accordance with the relevant rating regulations.</p> <p>For calculation purposes, the maximum apparent power of the sum of all power generation systems and storage units <math>\sum S_{Amax}</math> and usually the load factor <math>m = 1</math> shall be used. This does not apply to buried cables for the connection of photovoltaic systems where a load factor <math>m = 0,7</math> shall be used.</p>	Shall consider in final PGS	N/A

VDE-AR-N 4105:2018-11			
Clause	Requirement - Test	Result - Remark	Verdict
5.3	<p>Permissible voltage change</p> <p>For undisturbed operation of the network, the amount of the voltage change caused by all power generation systems with a network connection point in a low-voltage network shall at none of the PCCs in this network may a value of 3 % as compared with the voltage without power generation systems. Deviations from the value of <math>\Delta U_a \leq 3\%</math> are permissible as specified by the network operator (e. g. when using a controllable local network transformer). When calculating the voltage change, the displacement factor shall be taken into account which is provided by the network operator for the maximum apparent connection power of the power generation system <math>S_{Amax}</math>.</p>	Shall consider in final PGS	N/A
5.4	<p><b>Network interactions</b></p> <p>For power generation systems and storage units, the permissible limits for network interactions are also described in VDE-AR-N 4100, 5.4. For the connection evaluation of power generation systems and storage units, the connection owner provides the completed forms E.2 to E.5 to the network operator.</p>		N/A
5.5	<p><b>Connection criteria</b></p>		P
5.5.1	<p><b>General</b></p> <p>When connecting a power generation system or a storage unit, the technical connection conditions of the network operator shall be observed.</p>	Shall be considered full feed-in that in accordance with VDE-AR-N 4100 in the power system	P

VDE-AR-N 4105:2018-11			
Clause	Requirement - Test	Result - Remark	Verdict
5.5.2	<p><b>PAV, E monitoring (feed-in limitation)</b></p> <p>PAV, E monitoring allows a connection power PAV, E deviating from the installed power to be agreed with the network operator and to be set.</p> <p>The feed-in limit described in this sub-clause shall be measured at the central meter panel in accordance with VDE-AR-N 4100, 7.2.</p> <p>PAV, E monitoring can be an independent equipment mounted at the central meter panel in accordance with VDE-AR-N 4100 or in a suitable circuit distributor or may also be part of a power generation unit or a storage unit or a charging unit for electric vehicles. When PAV, E is exceeded, the power of the power generation system and/or the storage unit causing the event shall be reduced. PAV, E monitoring is to be used for monitoring the agreed active connection power PAV, E of power generation systems and/or storage units if the feed-in power at the network connection point PAV, E agreed with the network operator is smaller than the sum of the installed maximum active connection power of all power generation systems and/or storage units at that network connection point.</p>		N/A
5.5.3	<p><b>Power generation systems ready for connection</b></p> <p>In addition to the requirements specified in this VDE application guide, DIN VDE V 0100-551-1 (VDE V 0100-551-1) applies to power generation systems ready for connection.</p> <p>Provided a connection-ready power generation system is connected via an existing specific energy socket (e. g. complying with VDE V 0628-1 (VDE V 0628-1)) and a bidirectional meter is mounted at the central meter panel, the signature and the details of the system installer on the commissioning protocol E.8 may be omitted. A site map is not required in this case. This only applies up to a value <math>S_{Amax} \leq 600 \text{ VA}</math> per network user installation..</p>		N/A
5.6	<p><b>Three-phase inverter systems</b></p> <p>For three-phase power generation systems feeding into the network via inverters, the power feed-in into the three line conductors shall be three-phase balanced. The inverter circuit shall preferably be set up as a three phase current unit. The positive sequence system of the terminal voltages, even if they are unbalanced, is to be used as the reference quantity for the currents.</p>	The unit is a three-phase inverter that feed into three current balanced	P

VDE-AR-N 4105:2018-11			
Clause	Requirement - Test	Result - Remark	Verdict
5.7	<b>Behaviour of the power generation system at the network</b>		P
5.7.1	<p><b>General</b></p> <p>For frequencies between 47,5 Hz and 51,5 Hz, automatic disconnection from the network due to a frequency deviation is not permitted. The actual operating principle and the associated exceptions are detailed in 5.7.4.3. Frequency-dependent active power control is implemented in the open-loop control of the power generation units..</p> <p>In the frequency range of 47,5 Hz to 51,5 Hz, power generation systems shall be capable of network parallel operation in compliance with the time-related minimum requirements given in Table 1.</p> <p>Power generation units shall be able to ride through rapid frequency changes without disconnection from the network. This requirement applies provided the following averaged rates of change of frequency (RoCoF) are not exceeded:</p> <ul style="list-style-type: none"> <li>– ± 2,0 Hz/s for a moving time slot of 0,5 s; or</li> <li>– ± 1,5 Hz/s for a moving time slot of 1 s; or</li> <li>– ± 1,25 Hz/s for a moving time slot of 2 s.</li> </ul> <p>In case of rapid frequency changes, frequency measurements shall not take more than 200 ms. The minimum accuracy of frequency measurements is ± 50 mHz.</p>	<p>(See appended table)</p> <p>The unit is verified with ROCOF (2.0Hz/s) without disconnection.</p>	P
5.7.2	<b>Steady-state voltage stability/reactive power supply</b>		P

VDE-AR-N 4105:2018-11			
Clause	Requirement - Test	Result - Remark	Verdict
5.7.2.1	<p><b>General boundary conditions</b></p> <p>Steady-state voltage stability means the reactive power supply provided by a power generation system and/or a storage unit when energy is supplied for the purpose of voltage stability in the distribution network. The steady-state voltage stability is intended to keep slow (steady-state) voltage changes in the distribution network within acceptable limits. In case of three-phase feed-in, the reactive power supply associated with all three methods described in 5.7.2.4 a) to c) refers to the positive sequence system components of the current and voltage fundamental component. In a passive sign convention system (see A.8), this means the operation of the power generation system in Quadrant II (under-excited) or Quadrant III (over-excited). If a storage unit consumes energy from the network, the reactive power exchange at the network connection point shall comply with the contractual agreements regarding the network connection for customer installations for consumption (see VDE-AR-N 4100). It shall be possible to approach each set-point resulting from the applied control method according to the required reactive power range given in 5.7.2.2 and to operate the power generation unit therein for any duration. Changes of the reactive power supply within the agreed reactive power range shall be possible at any time. Upon agreement with the network operator, the reactive power control range may be extended..</p>		P
5.7.2.2	<p><b>Reactive power supply at <math>\Sigma S_{E_{max}}</math></b></p>		P
5.7.2.2.1	<p><b>General</b></p> <p>It is permissible in certain cases described in 5.7.2.2 and 5.7.3 to reduce the active power supply to the benefit of the reactive power supply. This is not considered a reduction of the active power supply in the context of network security management. Power generation systems shall comply with the reactive power supply irrespective of the number of feed-in phases under normal operating conditions in the voltage tolerance band <math>U_n \pm 10\%</math>.</p>		P

VDE-AR-N 4105:2018-11			
Clause	Requirement - Test	Result - Remark	Verdict
5.7.2.2.2	<p><b>Type 2 systems – inverters only</b></p> <p>At the generator terminals, each power generation unit to be connected shall meet the requirements according to Figure 2 and Figure 3.</p>		P
5.7.2.2.3	<p><b>Type 2 systems – Asynchronous generators (directly connected to the network and principally not able to control any reactive power)</b></p> <p>For power generation units with generators that are directly connected to the network and principally not able to control any reactive power and therefore use constant capacities, a constant displacement factor <math>\cos \phi = 0,95</math> under-excited with an accuracy of <math>\pm 0,02</math> at nominal voltage and rated power shall be observed.</p>	Inverter	N/A
5.7.2.2.4	<p><b>Type 1 systems and type 2 systems – stirling generators and fuel cells</b></p> <p>For power generation systems with a rated apparent power of <math>\Sigma S_{E_{max}} \leq 4,6</math> kVA , the network operator does not give any specifications. The value of <math>\cos \phi</math> lies within a range of <math>\cos \phi = 0,95</math> under-excited to <math>0,95</math> over-excited.</p> <p>At its generator terminals, each power generation unit to be connected in systems <math>\Sigma S_{E_{max}} &gt; 4,6</math> kVA shall meet the requirements according to Figure 4.</p>		N/A
5.7.2.3	<p><b>Reactive power supply smaller than <math>P_{E_{max}}</math></b></p> <p>In addition to the requirements for reactive power supply at the operating point <math>P_{E_{max}}</math> of the power generation unit (<math>P_{mom} = P_{E_{max}}</math>), requirements also apply to operation with an instantaneous active power <math>P_{mom}</math> smaller than <math>P_{E_{max}}</math>.</p> <p>The minimum requirement for the reactive power supply in partial load operating mode at the generator terminals is indicated as a red triangle on the <math>P/Q</math> diagram.</p> <p>Within the ranges given in Figure 5 or Figure 6, the maximum residual deviation between the set-point and the actual value of the reactive power at the generator terminals shall not exceed <math>\pm 4,0</math> % in relation to <math>P_{E_{max}}</math>.</p> <p>Within the range of <math>0 \leq P_{mom}/P_{E_{max}} &lt; 0,2</math> (or <math>0,1</math>, respectively), the power generation unit shall not exceed the reactive power value at the generator terminals of 10 % of the active power value <math>P_{E_{max}}</math> (reactive power supply and consumption respectively). Where a minimum technical power for a power generation unit has been agreed, the same conditions apply as for the range <math>0 \leq P_{mom}/P_{E_{max}} &lt; 0,2</math> (or <math>0,1</math>, respectively) between 0 and the minimum technical power.</p>	(See appended table)	P

VDE-AR-N 4105:2018-11			
Clause	Requirement - Test	Result - Remark	Verdict
5.7.2.4	<p><b>Methods for reactive power supply</b></p> <p>The reactive power supply for steady-state voltage stability shall not impair the dynamic network stability. The reactive power to be provided by the power generation system is limited to the range given in Figure 5 or Figure 6, respectively. In the context of network connection planning, the network operator prescribes to the connection owner one of the following methods for reactive power supply at the generator terminals of the power generation unit:</p> <p>a) reactive power voltage characteristic curve <math>Q(U)</math>; or</p> <p>b) displacement factor/active power characteristic curve <math>\cos \phi (P)</math>; or</p> <p>c) fixed displacement factor <math>\cos \phi</math>.</p> <p>The <math>Q(U)</math> rule applies only to three-phase power generation units connected to the three-phase current system. Here, too, the reactive power requirements are implemented at the generator terminals of the power generation units.</p>	<p>Method a, b and c are used for reactive power supply</p> <p>PGU <math>S_{E_{max}} \geq 4.6</math> kVA characteristic curve provided by the network operator within <math>\cos \phi = 0.90</math> under-excited to 0.90 over-excited.</p>	P
	<p><b>Re: a) reactive power voltage characteristic curve <math>Q(U)</math></b></p> <p>The objective of this method is the reactive power exchange between power generation unit and network depending on the actual voltage at the generator terminals of the power generation unit (<math>Q = f(U)</math>). The reference voltage <math>U_{Q0}</math> is <math>400 \text{ V} / \sqrt{3}</math>. The arithmetic mean of the r.m.s. values (optionally of the positive sequence system) of the three measured line-to-neutral voltages at the generator terminals of the power generation unit is the target value for the reactive power to be fed in on all line conductors. Voltage measurement shall not exceed a maximum measurement error of 1 % in relation to the nominal value.</p>	(See appended table)	P
	<p><b>Re: b) Displacement factor/active power characteristic curve <math>\cos \phi (P)</math></b></p> <p>The objective of this method is the reactive power supply by the power generation unit depending on the actual active power output (<math>Q = f(P_{mom})</math>).</p>	(See appended table)	P

VDE-AR-N 4105:2018-11			
Clause	Requirement - Test	Result - Remark	Verdict
	<p><b>Re: c) Displacement factor <math>\cos \phi</math></b>                      The objective of displacement factor control is the power feed-in by the power generation unit at a constant active power/apparent power ratio (<math>\cos \phi = \text{const}</math>). Thereby, the use of the reactive power control range given in Figure 5 and Figure 6 is restricted. For this purpose, the target value is defined with a minimum increment of <math>\Delta \cos \phi = 0,01</math>. The maximum permissible error tolerance of the reactive power feed-in is calculated using the error tolerance given in 5.7.2.3 of <math>\pm 4 \%</math> in relation to <math>P_{E\text{max}}</math>. The network operator predefines a displacement factor set-point.</p>	(See appended table)	P
5.7.2.5	<p><b>Requirements for reactive power methods of type 2 systems (inverters only) and type 1 systems</b>                      In the delivery state, none of the three reactive power methods specified in 5.7.2.4 is set as default. During the commissioning of power generation units, the method specified by the network operator shall be set by the system installer. Without the setting of the method specified by the network operator, power generation units shall not feed in any power.</p>		P
	<p>The control behaviour of the reactive power (methods a), b) and c)) with respect to set-point offsets corresponds to the PT-1 behaviour shown in Figure 10. Method a) deals with a closed control circuit under consideration of the network impedance. Each reactive power value resulting from the control behavior predefined by the network operator shall be adjustable within a range of 6 s to 60 s (from 10 s to 60 s for type 1) when being provided by the power generation unit. The time specified by the network operator corresponds to 3 Tau of a PT-1 behaviour or to the time until reaching 95 % of the set-point. If no actual value is predefined by the network operator for this purpose, the applicable value is 10 s for 3 Tau or 95 % of the set-point, respectively. The envelop delay time includes the determination of the network voltage or the active and reactive powers.</p>		P
5.7.2.6	<p><b>Special aspects regarding the extension of power generation systems</b>                      The requirements specified in 5.7.2.4 shall also be met by the newly added power generation units at their generator terminals. The reactive power supply by the added power generation units in accordance with 5.7.2.2 shall be determined based on the sum of the rated apparent powers of the existing power generation system and the newly added power generation units.</p>		P



VDE-AR-N 4105:2018-11			
Clause	Requirement - Test	Result - Remark	Verdict
5.7.3	<b>Dynamic network stability</b>		P
5.7.3.1	<b>General</b>	(See appended table)	P
5.7.3.2	<p><b>Dynamic network stability for type 1 units</b></p> <p><b>Transient stability – Reaction to network faults</b></p> <p>Regarding the power generation unit remaining connected to the network, the following applies to type 1 units: Throughout the operating range of the power generation unit, voltage drops caused by single-phase, two phase or three-phase network faults and the subsequent voltage transient phenomena shall not cause the power generation unit to become unstable or to disconnect from the network if the voltage assumes values within the limit curves shown in Figure 11 (red for the under-voltage limit curve, blue for the over-voltage limit curve).</p>		N/A
5.7.3.3	<p><b>Dynamic network stability for type 2 units and storage units</b></p> <p>The following conditions apply to all type 2 power generation units and storage units: As long as the line-neutral-voltages at the generator terminals of the power generation unit or storage unit do not exceed the limit curves shown in Figure 12 (red for the under-voltage limit curve, blue for the over-voltage limit curve), both the power generation unit and the storage unit shall neither become unstable nor disconnect from the network throughout the operating range.</p>		P
	<p>For evaluating the curves, the smallest respective value of the line-neutral-voltages at the power generation unit or the storage unit shall be used in case of a voltage drop, and the highest respective value of the line-neutral- voltages at the power generation unit or the storage unit shall be used in case of a voltage rise.</p> <p>As far as the set values for the NS protection given in Table 2 (column “Inverter(s)”) anticipate the requirements given in Figure 12 in certain working points, merely the checking of the set values for NS protection is required for the verification procedure.</p>		P
	<p>If the voltage at the generator terminals falls below <math>&lt; 0,8 U_n</math> or exceeds <math>&gt; 1,15 U_n</math> (onset of fault), type 2 power generation units and storage units shall ride through voltage drops without feeding current into the network of the network operator (limited dynamic network stability).</p>		P

VDE-AR-N 4105:2018-11			
Clause	Requirement - Test	Result - Remark	Verdict
	This requirement is deemed to be met, if the current fed in by the power generation unit(s) and/or the storage unit in any line conductor does not exceed 20 % of the rated current $I_r$ within 60 ms and 10 % of $I_r$ within 100 ms upon a voltage drop below 0,8 $U_n$ or a voltage rise above 1,15 $U_n$ .		P
	<p><b>Behaviour after the end of a fault</b></p> <p>If, after the end of a fault, the network voltage resumes a value within the voltage band from -15 % <math>U_n</math> to +10 % <math>U_n</math> and the active current of the power generation unit and/or the storage unit has been reduced during the network fault, it shall, immediately after the end of the fault, be increased to its pre-fault value as quickly as possible. The transient period shall not exceed a maximum of 1 s. The reactive power supply follows 5.7.2.5 in its time-related behaviour. In case of rotating machinery, the transient period shall not exceed a maximum of 6 s. At voltages of 1,15 <math>U_n</math>, the power generation units and storage units shall not disconnect from the network for a period of up to 60 s after the onset of the fault. If the tripping of the self-protection of the power generation units and/or the storage unit is imminent, these units can adjust their reactive power behaviour such as to prevent self-protection tripping.</p>		P
5.7.4	<b>Active power output</b>		P
5.7.4.1	<p><b>General</b></p> <p>In cases where set-points are specified by a third party (e. g. direct marketing) and of network security management in accordance with 5.7.4.2, the new set-point shall be approached with the customer installation's power gradients listed below in relation to the network connection point. Implementation of those power gradients directly at the power generation units or storage units is sufficient for meeting the requirement.</p> <p>The following power gradients shall be observed for increasing/reducing the active power output of power generation systems (minimum technical power or 5 % <math>P_{Amax} \leftrightarrow 100\% P_{Amax}</math>) as well as the energy supply and consumption by storage units (5 % <math>P_{Amax} \leftrightarrow 100\% P_{Amax}</math>):</p> <ul style="list-style-type: none"> <li>- at a maximum rate of 0,66 % <math>P_{Amax}</math> per s;</li> <li>- at a minimum rate of 0,33 % <math>P_{Amax}</math> per s. Power generation systems may react more slowly in case of set-points specified by third parties and of power increases. For this purpose, a minimum rate of 4 % <math>P_{Amax}</math> per minute should be observed.</li> </ul>	The active power can be remote-controlled on the communication interface	P

VDE-AR-N 4105:2018-11			
Clause	Requirement - Test	Result - Remark	Verdict
	<p>Other technically induced power gradients (e. g. for hydro power generation systems with level control depending on network demands) are permissible upon approval by the network operator.</p> <p>The power increase or reduction of the customer installation shall be realised in a uniform process, i. e. with a behaviour as linear as possible. The specification of set-points by third parties shall be realised on the level of the individual customer installation or by the sum of all systems accessed by a third party (e. g. by uniform distribution of the active powers to be connected or disconnected over a total period of <math>\geq 2,5</math> min).</p>		N/A
	<p>The power generation system or storage unit shall be provided with a logical interface (inlet port) which, irrespective of the power gradients listed above, allows to terminate the active power output within 5 s upon reception of a corresponding signal from the network operator. Additionally, the interface may be used for network security management.</p>		P
5.7.4.2	<b>Network security management</b>		P

VDE-AR-N 4105:2018-11			
Clause	Requirement - Test	Result - Remark	Verdict
5.7.4.2.1	<p><b>Types of power generation systems and storage units</b></p> <p>If not specified otherwise by legislation, the requirements described below apply.</p> <p><b>Photovoltaic systems</b></p> <p>PV systems shall contribute to the avoidance of network overload. For this purpose, PV system power is divided into three power groups:</p> <ul style="list-style-type: none"> <li>– For PV systems up to and including 30 kWp, the system operator may chose between two options:               <ul style="list-style-type: none"> <li>a) by means of a corresponding inverter design or a certified technical control, the active power feed-in of the PV system shall be permanently limited to a maximum value of 70 % of the installed module power at the network connection point with the power gradients given in 5.7.4.1; or</li> <li>b) the PV system shall be provided with a technical means for remote-controlled reduction of the feedin power by the network operator.</li> </ul> </li> <li>– PV systems &gt; 30 kWp up to and including 100 kWp shall be provided with a technical means enabling the remote-controlled reduction of the feed-in power by the network operator.</li> <li>– PV systems &gt; 100 kWp shall be provided with a technical means enabling the remote-controlled reduction of the feed-in power by the network operator and for the provision of the actual feed-in power.</li> </ul> <p>If the installed total power increases to &gt; 100 kWp due to the installation of a further PV system on the same plot or building within a period of 12 months, legal provisions require implementation of the feed-in management for systems &gt; 100 kWp while providing the actual feed-in power for the total power..</p>	The active power can be remote-controlled on the communication interface	P
	<p><b>Cogeneration of power and heat (CHP) systems, wind, biogas, hydroelectric power as well as landfill and sewage gas systems</b></p> <p>Those PV systems with <math>P_{Amax} &gt; 100</math> kW shall be provided with a technical means enabling the remote-controlled reduction of the feed-in power by the network operator and for the provision of the actual feed-in power.</p>		N/A

VDE-AR-N 4105:2018-11			
Clause	Requirement - Test	Result - Remark	Verdict
	<p><b>Storage units buffering EEG or KWKG systems</b>                      Those storage units with <math>P_{Amax} &gt; 100</math> kW shall be provided with a technical means enabling the remote controlled reduction of the feed-in power by the network operator and for the provision of the actual feed-in power.                      These requirements do not apply if the feeding into the network of the network operator by a storage unit is prevented by technical control means. This shall be demonstrated by means of a manufacturer's declaration.</p>		N/A
	<p><b>Any EEG and KWKG systems with an intelligent measurement system</b>                      If an intelligent measurement system is present, the network operator may demand the metering point operator to transmit network state data (i. e. also the actual feed-in power).</p>		N/A
	<p><b>Any power generation systems and storage units other than those indicated above</b>                      All power generation systems and storage units shall be provided with technical means enabling the remote-controlled reduction of the feed-in power by the network operator and for the provision of the actual feed-in power.</p>		P
5.7.4.2.2	<p><b>Implementation of network security management</b>                      Power generation systems and storage units shall be able to reduce their active power to a power value predetermined by the network operator at the network connection point without disconnecting from the network. The following values have proved effective: 100 %/60 %/30 %/0 % in relation to the installed active feed-in power <math>P_{Amax}</math>. Instead of reducing the generated active power, the consumed power of the customer installation can be increased, too. The sum of the reduced generated active power and/or the increased consumed active power at the network connection point shall not deviate by more than <math>\pm 5</math> % from the setpoint of active power limitation. Power reduction shall be possible for any operating state and from any operating point. In case of a redispatch, the power generation systems shall be technically capable of increasing the power to a maximum of <math>P_{Amax}</math> upon the network operator's request.</p>	(See appended table)	P

VDE-AR-N 4105:2018-11			
Clause	Requirement - Test	Result - Remark	Verdict
5.7.4.2.3	<p><b>Active power adjustment at over-frequency and under-frequency</b></p> <p>A network frequency outside the tolerance band of <math>\pm 200</math> mHz around the nominal network frequency of 50,0 Hz indicates the presence of a critical system state in the integrated network where any power generation units and storage units shall contribute to the network frequency support.</p> <p>The accuracy of the frequency measurement in the steady state shall be <math>\leq \pm 10</math> mHz.</p> <p>The requirements given in 5.7.4.3 do not apply to storage units in standby mode. Additionally, DC coupled storage units shall behave as type 2 units.</p> <p>In case of <b>over-frequency</b>, an excess of generated power is opposed by a deficit of consumed power. Therefore, all power generation units and storage units shall be able to adjust the active power working point at an over-frequency up to a maximum of 51,5 Hz (see Figure 14 and Figure 15).</p> <p>Power generation units shall enable the frequency for starting this frequency-dependent active power feed-in to be set to a value between 50,2 Hz and 50,5 Hz. Unless specified otherwise by the network operator, this start frequency shall be set to 50,2 Hz. The static value of the frequency-dependent active power feed-in shall be adjustable within a range of 2 % to 12 %.</p> <p>This corresponds to a power gradient within a range of 16,67 % of <math>P_{ref}</math> per Hertz (<math>s = 12</math> %) to 100 % of <math>P_{ref}</math> per Hertz (<math>s = 2</math> %). Unless specified otherwise by the network operator, a gradient of 40 % of <math>P_{ref}</math> per Hertz (<math>s = 5</math> %) shall be set (see Figure 14).</p> <p>For storage units, the generated active power with a gradient of 40 % of <math>P_{E_{max}}</math> per Hertz (<math>s = 5</math> %) shall be reduced or increased (see Figure 15).</p> <p>Consequently, the power generation unit or the storage unit will constantly move up and down along the frequency characteristic within the frequency range of 50,2 Hz (unless specified otherwise for power generation units by the network operator) to 51,5 Hz with regard to its maximum possible active power feed-in ("operation along the characteristic").</p>	<p>(See appended table)</p> <p>The starting frequency can be set from 50.2 to 50.5Hz,</p> <p>And, power gradient 2%-12% adjustable</p> <p>Default 50.2 and power gradient 5% setting.</p>	P

VDE-AR-N 4105:2018-11			
Clause	Requirement - Test	Result - Remark	Verdict
	<p>At frequencies below 49,8 Hz, all power generation units shall increase the instantaneous generated active power <math>P_{mom}</math> with a gradient of 40 % <math>PE_{max}</math> per Hertz (<math>s = 5</math> %) to its technically possible maximum value. For storage units, a gradient of 100 % <math>PE_{max}</math> per Hertz (<math>s = 2</math> %) applies. The maximum value is determined by the actual primary energy supply as well as the actually usable storage power. Power reductions for the protection of operating equipment are permitted even at under-frequency. For CHP systems, power reductions resulting from a heat-lead operating mode or a power drop due to the rotational speed are also permitted. Storage units dedicated to other purposes (e. g. gas storage units in biogas systems, DC buffer storage elements for self-consumption etc.) should be activated for this purpose. System-integrated storage units with an energy level below <math>P_n \times 30</math> s (e. g. smoothing chokes, indirect capacitors etc.) may be neglected for this application. Consequently, power generation units and storage units will constantly move up and down along the frequency characteristic also within the frequency range of 49,8 Hz to 47,5 Hz or 47,8 Hz with regard to their maximum possible active power feed-in ("operation along the characteristic").</p> <p>At an under-frequency within the range of 49,8 Hz to 47,5 Hz, all storage units in charging mode shall reduce their instantaneous charging power according to the characteristic curve shown in Figure 15 to its technically possible minimum value ("operation along the characteristic"). In addition, storage units, as far as their charging state permits, shall change into the operating mode "energy supply" and increase their power according to the characteristic curve shown in Figure 15. In this case, system stability is of higher priority than a potential restraint for feeding storage energy into the network of the network operator based on technical/financial requirements.</p> <p>At network frequencies <math>f &lt; 47,5</math> Hz, power generation units and storage units shall disconnect from the network (see Figure 14 and Figure 15).</p>	<p>Storage units, a gradient of 100 % <math>PE_{max}</math> per Hertz (<math>s = 2</math> %) applies</p> <p>(See appended table)</p>	P

VDE-AR-N 4105:2018-11			
Clause	Requirement - Test	Result - Remark	Verdict
	<p><b>Requirements for the control times for power generation units and storage units</b></p> <p>The initial time delay <math>T_V</math> of the frequency-dependent adjustment of the active power output at over-frequency and under-frequency is part of the transient period and shall preferably be <math>\leq 2</math> s. In case of a time delay <math>&gt; 2</math> s, the operator of the power generation system shall justify that delay by submitting technical proof to the transmission network operator. For type 2 power generation units and storage units, the necessary initial time delays <math>T_V</math> for reaching the required transient periods are significantly shorter than 2 s.</p> <p>For the time curve of the frequency-dependent active power adjustment, the following conditions regarding the initial time delay <math>T_V</math> and the transient period <math>T_{an\_90\%}</math> shall be observed:</p> <ul style="list-style-type: none"> <li>– After <math>T_V + 0,1 \times (T_{an\_90\%} - T_V)</math> has elapsed, a value of at least 9 % of the required power adjustment <math>\Delta P</math> has been reached.</li> <li>– After the transient period <math>T_{an\_90\%}</math> has elapsed, a value of 90 % of the power adjustment <math>\Delta P</math> has been reached.</li> </ul>		P
	<p>During the control process (“operation along the characteristic”), the power generation unit and the storage unit shall respond as quickly as possible to sudden network frequency changes within a frequency range of 50,2 Hz to 51,5 Hz (subject to capability as declared by the manufacturer) with a transient period of 8 s for <math>\Delta P \leq 45\%</math> of <math>P_{E_{max}}</math> and <math>\Delta P</math> for power changes beyond that in case of type 1 units and type 2 units with rotating machinery and 2 s in case of all other type 2 power generation units and 1 s in case of storage units.</p> <p>The settling period shall not exceed 30 s for type 1 units and type 2 units with rotating machinery or 20 s for all other type 2 power generation units and for storage units.</p> <p>After settling, the supplied active power should deviate by <math>\leq \pm 10\%</math> <math>P_{E_{max}}</math> from the set-point.</p> <p>The same requirements shall be applied to the active power increase at an under-frequency between 49,8 Hz and 47,5 Hz.</p>		P



VDE-AR-N 4105:2018-11			
Clause	Requirement - Test	Result - Remark	Verdict
	<p><b>Conditional requirements based on technical restrictions</b></p> <p>As an alternative to active power reduction at over-frequency, non-controllable power generation units may disconnect from the network within the frequency range of 50,2 Hz to 51,5 Hz; in that case, uniform distribution of the disconnection frequency in maximum increments of 0,1 Hz shall be ensured for each system type by the manufacturer.</p> <p>Power generation units of limited variability, e. g. only within the range of 70 % to 100 % <math>P_{E_{max}}</math>, can be curtailed within that range in accordance with the characteristic curve. Outside the controllable range, disconnection is then carried out according to the uniformly distributed shut-down limit curve.</p> <p>For power generation units with combustion engines or gas turbines, active power reduction occurs with a power gradient of at least 66 % <math>P_{E_{max}}</math> per minute (equals 1,11 % <math>P_{E_{max}}</math> per second). Thus, the transient period of 8 s can be observed up to a power reduction of 8,88 % <math>P_{E_{max}}</math>. In case of a greater change of frequency, the transient period is accordingly higher.</p> <p>Linear generators, such as stirling machines up to a maximum apparent power of <math>S_{A_{max}} \leq 4,6</math> kVA, are exempt from the active power feed-in at over/under-frequency. They may remain connected to the network within a frequency range between 50,2 Hz and their maximum upper frequency limit and may disconnect from the network if this value is exceeded or, at the latest, when a frequency of 51,5 Hz is reached or exceeded.</p> <p>At an under-frequency between 49,8 Hz and their maximum lower frequency limit, linear generators should remain connected to the network but shall disconnect from it at the latest when a frequency of 47,5 Hz is reached or exceeded.</p>		N/A

VDE-AR-N 4105:2018-11			
Clause	Requirement - Test	Result - Remark	Verdict
	<p><b>End of critical network state and return to normal operation</b>            Even if the network frequency has resumed a value within the tolerance band of 50,0 Hz ± 200 mHz after a frequency deviation, a critical network state has still to be assumed initially.            The time for transition from the critical network state to normal operation is limited by a maximum change of the active power set-point based on <math>P_{mom}</math>.            This change of the active power set-point (except for providing the operating reserve) shall be limited to a maximum gradient of 10 % of the active power <math>P_{Emax}</math> per minute (under consideration of 5.7.1).            Only after the network frequency has been within the tolerance band of 50,0 Hz ± 200 mHz for 10 min continuously, the normal operation of the network is deemed to be restored whereupon this requirement does no longer apply.</p>		P
5.7.4.4	<p><b>Voltage-dependent active power reduction</b>            In order to avoid disconnection of the power generation system due to over-voltage protection <math>U &gt;</math>, it is permissible to reduce the active power feed-in as a function of the voltage of (a) power generation unit(s).            Implementation is then chosen by the system manufacturer. This is not considered an active power reduction in the context of feed-in management in compliance with EEG.            Surges or oscillations of the active power feed-in are not permitted for that purpose.</p>		N/A
5.7.5	<p><b>Short-circuit contribution</b>            Due to the operation of a power generation system, the short-circuit current of the low-voltage network is increased by the short-circuit current of the power generation system. Therefore, the short-circuit current of the power generation system to be expected at the network connection point shall be indicated in accordance with 4.2. For the determination of the initial short-circuit AC current contribution <math>I_{kA}</math> of a power generation system, the following roughly estimated values can be assumed:            – for synchronous generators: 8 times the rated current;            – for asynchronous generators: 6 times the rated current;            – for generators and storage units with inverters: the rated current.            If the power generation system causes a short-circuit current increase in the network operator's network in excess of the rated value, then connection owner and network operator shall agree upon appropriate measures limiting the short-circuit current from the power generation system accordingly.</p>		P

VDE-AR-N 4105:2018-11			
Clause	Requirement - Test	Result - Remark	Verdict
6	<b>Construction of the power generation system/network and system protection (NS protection)</b>		P
6.1	<p><b>General requirements</b></p> <p>The network and system protection (NS protection) is a type-tested protective device with a NS protection certificate (see Form E.6) wherein all protective functions specified in 6.5 are installed. The NS protection acts on the interface switch in accordance with 6.4.</p> <p>Depending on the sum of the maximum apparent powers of all power generation systems and storage units connected to the same network connection point <math>\Sigma S_{Amax}</math>, the following conditions apply to the NS protection:</p>		P
6.2	<p><b>Central NS protection</b></p> <p>The central NS protection shall be accommodated, installed and connected as an independent equipment at the central meter panel in a suitable circuit distributor in accordance with VDE-AR-N 4100, Clause 8, Paragraph 1, and not in the upper connection compartment according to VDE-AR-N 4100, 7.2, Paragraph 11.</p> <p>Examples of the arrangement of the central NS protection and hence the connection of power generation systems to meter panels are shown in Annex C.</p> <p>For central NS protection, it is additionally required to carry out a trigger test for checking the tripping circuit "NS protection – interface switch". For this purpose, the central NS protection is provided with a means for tripping the interface switch (e. g. by means of a test button) for testing purposes. Activation shall be visualised at the interface switch.</p>	Models SOFAR 30000TL-G2, SOFAR 33000TL-G2 shall have a central NS protection in the end installation	N/A
6.3	<p><b>Integrated NS protection</b></p> <p>In the case of integrated NS protection, the NS protection can be integrated in the programmable system control of the power generation units (e. g. in the inverter control). In this case, the means for testing the tripping circuit "NS protection – interface switch" by the system installer is not required.</p> <p>The integrated NS protection acts on an integrated interface switch (see 6.4.3).</p>	For models SOFAR 20000TL-G2 and SOFAR 25000TL-G2 have integrated NS protection	P
6.4	<b>Interface switch</b>	The PSU include integrated interface switch and is type tested in the report	P

VDE-AR-N 4105:2018-11			
Clause	Requirement - Test	Result - Remark	Verdict
6.4.1	<p><b>General</b></p> <p>For the connection of the power generation system to the network operator's low-voltage network or to the remaining customer installation, an interface switch shall be used. The interface switch is controlled by the NS protection and automatically triggers if at least one protective function responds.</p> <p>As interface switches, the switching devices of the individual power generation units (integrated interface switch) can be used.</p> <p>The integrated interface switches can also be used in combination with the central NS protection. In any case, central NS protection from <math>\Sigma S_{Amax} &gt; 30</math> kVA (sum of the maximum apparent powers of all power generation systems and storage units connected to the same network connection point; for exceptions, see 6.1) shall be directly connected to the central meter panel. Where a signal is routed to a spatially separate switching device, it shall be ensured that the required disconnection periods given in Table 2 are observed and lead to the disconnection of the power generation system. During commissioning of the power generation system, a tripping test of the interface switch shall be conducted.</p> <p>The interface switch shall be designed for the rated conditional short-circuit current and under consideration of the protective devices required according to 6.5 and it shall enable instantaneous tripping. The switching capacity of the interface switch shall be rated according to the rated current of the upstream fuse or the maximum initial short-circuit AC current contribution of the power generation system, whichever is the higher.</p> <p>The functional check of the interface switch shall be carried out according to a) or b) or c):</p> <p>a) by using an interface switch which, in its active state, requires a control voltage to be applied continuously and which disconnects automatically when this voltage is no longer applied. The operational connection and disconnection processes shall be monitored;</p> <p>b) by connection and disconnection of the interface switch via the NS protection and monitoring its proper functioning (e. g. break contact of a monitoring contact) at least once daily;</p> <p>c) by using the integrated interface switch and the integrated NS protection for PV and battery inverters in compliance with DIN EN 62109 (VDE 0126-14).</p> <p>When a defect of the interface switch is detected, the power generation system shall neither feed in nor reconnect.</p>	<p>Integrated interface switch has been type tested in compliance with DIN EN 62109</p>	P

VDE-AR-N 4105:2018-11			
Clause	Requirement - Test	Result - Remark	Verdict
6.4.2	<p><b>Central interface switch</b></p> <p>The central interface switch shall be a galvanic break device (e. g. mechanical contactor, protective motor switch, mechanical circuit breaker). For a power generation system required to contribute to the dynamic network stability, an interface switch enabling compliance with the requirements specified in 5.7.3 (no malfunction at under-voltage in the context of the FRT requirements) shall be used.</p> <p>The interface switch shall be installed in the distribution field of or directly at the central meter panel in a circuit distributor. Examples of the arrangement of interface switches and hence the connection of power generation systems to meter panels are shown in Annex C.</p>		N/A
6.4.3	<p><b>Integrated interface switch</b></p> <p>For the construction of the interface switch, the requirements specified in 6.1 shall be considered. The interface switch (e. g. power relay, mechanical contactor, mechanical circuit-breaker, etc.) ensures galvanic breaking.</p> <p>For power generation systems with inverters, the interface switch shall be provided on the inverter's network side.</p>	Integrated power relay in the PGU. Each live conductor is constructed with two relays	P
6.5	<b>Protective devices and protection settings</b>		P
6.5.1	<p><b>General</b></p> <p>The purpose of NS protection is to disconnect the power generation system from the network in the event of inadmissible voltage and frequency values (also refer to DIN VDE 0100-551 (VDE 0100-551)). This is meant to prevent inadvertent feed-in from the power generation system into a partial network separated from the main distribution network.</p>		P
6.5.2	<p><b>Protective functions</b></p> <p>The NS protection shall be provided with a means for preventing unauthorised access (z. B. sealable, password protection). The rise-in-voltage protection <math>U &gt;</math> shall be designed such as to be adjustable in the NS protection (see Table 2, Footnote b). Additionally, the time delay of the voltage drop protection <math>U &lt;</math> and <math>U &lt;&lt;</math> for directly coupled synchronous and asynchronous generators with <math>P_n &gt; 50</math> kW shall also be designed such as to be adjustable in the NS protection (see Table 2, Footnote d). Any other protective functions listed in 6.5.1 are either to be installed permanently, i. e. not adjustable, in the NS protection or to be provided with an additional separate protection against unauthorised access (e. g. password protection) for preventing modifications.</p>	(See appended table)	P

VDE-AR-N 4105:2018-11			
Clause	Requirement - Test	Result - Remark	Verdict
6.5.3	<b>Islanding detection</b>	(See appended table)	P
6.6	<b>Further requirements for power generation systems</b>	Shall be considered in PGS	N/A
7	<b>Metering for billing purposes</b>		N/A
8	<b>Operation of the system</b>		P
8.1	<b>General</b>		P
8.2	<b>Special aspects of the management of the network operator's network</b>		N/A
8.3	<b>Connection conditions and synchronisation</b>		P
8.3.1	<p><b>General</b></p> <p>Power generation systems and storage units shall be connected to the network operator's network only if a suitable device determines that both the mains voltage and the mains frequency are within the tolerance range of 85 % <math>U_n</math> to 110 % <math>U_n</math> or 47,5 Hz to 50,1 Hz, respectively, for a period of at least 60 seconds.</p> <p>Additionally, the delay times for the reconnection of a generator and the staggered times applicable when connecting several generators shall be sufficient for safely finishing any control and adjustment processes within the power generation system and/or the storage unit caused by the connection.</p> <p>In case of power generation systems and storage units being reconnected to the network operator's network at the tripping of the NS protective device or the PAV, E monitoring, the active power of controllable power generation systems and storage units supplied to the network operator's network shall not exceed the gradient of 10 % of the active power <math>P_{Amax}</math> per minute. Non-controllable power generation systems and storage units can connect after 1 min to 10 min (random generator) or later.</p>	(See appended table)	P
8.3.2	<b>Connection of synchronous generators</b>		N/A
8.3.3	<b>Connection of asynchronous generators</b>		N/A
8.3.4	<p><b>Connection of power generation units and storage units with inverters</b></p> <p>Power generation units with inverters (such as photovoltaic systems) and storage units with inverters shall only be connected with <math>k_{imax} \leq 1,2</math>.</p>		P
8.4	<b>Special aspects regarding the planning, installation and operation of power generation systems and storage units each with <math>P_{Amax} \geq 135</math> kW</b>		N/A
9	<b>Verification of electrical properties</b>		P

VDE-AR-N 4105:2018-11			
Clause	Requirement - Test	Result - Remark	Verdict
	<b>Annex A: Explanations (informative)</b>		
	<b>Annex B: Connection examples and measurement strategies (informative)</b>		
	<b>Annex C: Examples of meter panel configurations (informative)</b>		
	<b>Annex D: Examples for the connection evaluation of power generation systems - Connection of a 20 kW PV system (informative)</b>		
	<b>Annex E: Forms (mandatory)</b>		<b>P</b>
E.1	Application procedure		N/A
E.2	Data sheet for power generation systems		N/A
E.3	Data sheet for storage units		N/A
E.4	Unit certificate		P
E.5	Test report "Network interactions" for power generation units with an input current > 75 A		P
E.6	Certificate of the network and system protection		P
E.7	Requirements for the test report for the NS protection		P
E.8	Commissioning protocol for power generation systems and/or storage units		N/A
E.9	Type approval procedure		N/A

**Appended Table - Testing Result**

5.2.2	TABLE: Rapid voltage change			P
Operation type: Switching on at any power level (without default to primary energy source)				
Condition	Test 1: $\cos\varphi=1$	Test 2: $\cos\varphi=0.90$ over-excited	Test 3: $\cos\varphi=0.90$ under-excited	
Ki	0.05	0.02	0.02	
Kimax Limit	<1.2			
Operation type: start-up at Pn (reference condition) with circuit breaker reclosing				
Condition	Test 1: $\cos\varphi=1$	Test 2: $\cos\varphi=0.90$ over-excited	Test 3: $\cos\varphi=0.90$ under-excited	
Ki	0.04	0.03	0.03	
Kimax Limit	<1.2			
Operation type: shut-down (breaking operation at nominal power)				
Condition	Test 1: $\cos\varphi=1$	Test 2: $\cos\varphi=0.90$ over-excited	Test 3: $\cos\varphi=0.90$ under-excited	
Ki	0.16	0.14	0.14	
Kimax Limit	<1.2			
Note:				
1) $S_{k, fic}/S_n = 20$				
2) ki is the ratio of the highest current occurring during a switching operation to the normal generator current, the current is to be considered as an r.m.s. value over a period				

Switching actions	Ki
Marking operation without default (to primary energy carrier)	0.05
Worst case at switch over of generator sections	0.05
Marking operation at reference conditions (of primary energy carrier)	0.04
Breaking operation at nominal power	0.16
Worst case value of all switching operations Ki max	0.16



5.2.3	TABLE: Flick				P
Test impedance	0.24Ω +0.15j				
Grid impedance angle, Ψk	30°C	50°C	70°C	85°C	
Flick coefficient, c(Ψk)	3.06	2.01	1.63	1.53	
Short-term flicker, Pst	0.18	0.12	0.10	0.09	
Note:					
1) Sk, fic/Sn = 20					

5.2.4	TABLE: Harmonics and inter-harmonics (according to DIN EN 61000-3-2) Model: SOFAR 20000TL-G2										P
Active power P/P <sub>n</sub> [%]	10	20	30	40	50	60	70	80	90	100	Limit [%]
Harmonic number	[%]	[%]	[%]	[%]	[%]	[%]	[%]	[%]	[%]	[%]	
2	0.069	0.074	0.051	0.064	0.095	0.119	0.116	0.114	0.116	0.117	8.00
3	0.109	0.136	0.106	0.104	0.131	0.158	0.155	0.153	0.142	0.128	21.60
4	0.045	0.057	0.034	0.043	0.051	0.064	0.064	0.066	0.070	0.086	4.00
5	0.425	0.213	0.118	0.066	0.103	0.188	0.244	0.306	0.338	0.345	10.70
6	0.044	0.035	0.018	0.020	0.028	0.022	0.021	0.023	0.029	0.034	2.67
7	0.521	0.206	0.097	0.045	0.084	0.167	0.232	0.308	0.345	0.358	7.20
8	0.039	0.028	0.020	0.023	0.035	0.033	0.031	0.030	0.029	0.038	2.00
9	0.069	0.080	0.079	0.062	0.037	0.035	0.033	0.046	0.041	0.052	3.80
10	0.023	0.022	0.017	0.013	0.037	0.041	0.045	0.048	0.046	0.047	1.60
11	0.669	0.359	0.169	0.104	0.095	0.153	0.197	0.240	0.279	0.307	3.10
12	0.028	0.009	0.015	0.019	0.028	0.031	0.039	0.046	0.049	0.049	1.33
13	0.433	0.278	0.156	0.109	0.113	0.158	0.209	0.254	0.286	0.301	2.00
14	0.019	0.012	0.012	0.014	0.030	0.047	0.052	0.055	0.051	0.049	--
15	0.034	0.028	0.029	0.029	0.031	0.035	0.029	0.030	0.029	0.032	--
16	0.027	0.017	0.007	0.013	0.026	0.028	0.030	0.032	0.030	0.029	--
17	0.280	0.235	0.171	0.121	0.094	0.089	0.090	0.090	0.113	0.133	--
18	0.014	0.015	0.006	0.007	0.005	0.011	0.013	0.015	0.017	0.018	--
19	0.175	0.133	0.136	0.119	0.092	0.074	0.082	0.084	0.098	0.120	--
20	0.013	0.014	0.011	0.011	0.021	0.024	0.020	0.019	0.017	0.019	--
21	0.037	0.023	0.014	0.017	0.012	0.012	0.013	0.014	0.014	0.018	--
22	0.012	0.012	0.005	0.008	0.012	0.017	0.018	0.016	0.015	0.016	--
23	0.177	0.043	0.088	0.103	0.083	0.067	0.053	0.054	0.068	0.078	--
24	0.010	0.008	0.004	0.007	0.009	0.006	0.006	0.007	0.007	0.007	--
25	0.131	0.047	0.054	0.090	0.088	0.082	0.078	0.075	0.084	0.090	--
26	0.010	0.009	0.008	0.007	0.008	0.009	0.009	0.013	0.013	0.013	--
27	0.016	0.019	0.012	0.010	0.010	0.012	0.013	0.014	0.014	0.015	--
28	0.008	0.009	0.005	0.006	0.007	0.010	0.009	0.010	0.012	0.011	--
29	0.087	0.085	0.018	0.062	0.070	0.068	0.064	0.062	0.064	0.070	--
30	0.009	0.005	0.004	0.004	0.006	0.004	0.005	0.006	0.008	0.007	--
31	0.062	0.102	0.027	0.052	0.074	0.071	0.060	0.057	0.060	0.070	--
32	0.011	0.005	0.004	0.009	0.006	0.009	0.011	0.014	0.014	0.015	--
33	0.017	0.016	0.009	0.013	0.009	0.009	0.010	0.012	0.012	0.012	--
34	0.011	0.006	0.004	0.006	0.005	0.006	0.008	0.010	0.011	0.011	--
35	0.044	0.102	0.030	0.035	0.059	0.062	0.050	0.039	0.043	0.051	--
36	0.007	0.004	0.004	0.004	0.004	0.005	0.004	0.006	0.006	0.006	--
37	0.049	0.092	0.030	0.018	0.047	0.070	0.067	0.066	0.068	0.071	--
38	0.009	0.003	0.004	0.007	0.005	0.007	0.006	0.009	0.010	0.010	--
39	0.010	0.012	0.007	0.012	0.006	0.008	0.008	0.010	0.011	0.011	--
40	0.008	0.004	0.004	0.005	0.005	0.005	0.006	0.008	0.009	0.009	--

<b>5.2.4 TABLE: Harmonics and inter-harmonics (According to DIN EN 61000-4-7 )</b>											
<b>Model: SOFAR 20000TL-G2</b>											
Active power P/Pn [%]	0	10	20	30	40	50	60	70	80	90	100
Frequency [Hz]	[%]	[%]	[%]	[%]	[%]	[%]	[%]	[%]	[%]	[%]	[%]
75	0.020	0.007	0.005	0.005	0.004	0.004	0.005	0.005	0.006	0.006	0.007
125	0.014	0.018	0.016	0.016	0.018	0.018	0.017	0.017	0.018	0.019	0.020
175	0.006	0.006	0.005	0.005	0.004	0.006	0.006	0.006	0.007	0.009	0.011
225	0.021	0.008	0.005	0.005	0.005	0.005	0.005	0.006	0.006	0.007	0.007
275	0.007	0.007	0.006	0.006	0.006	0.006	0.007	0.006	0.008	0.010	0.012
325	0.010	0.008	0.006	0.006	0.006	0.007	0.009	0.009	0.010	0.011	0.014
375	0.021	0.014	0.011	0.012	0.012	0.012	0.011	0.011	0.013	0.013	0.014
425	0.008	0.013	0.012	0.013	0.014	0.014	0.015	0.015	0.014	0.021	0.024
475	0.005	0.012	0.012	0.013	0.013	0.015	0.017	0.016	0.019	0.021	0.021
525	0.005	0.008	0.008	0.008	0.009	0.010	0.010	0.012	0.014	0.014	0.017
575	0.003	0.006	0.006	0.006	0.006	0.007	0.007	0.007	0.008	0.009	0.012
625	0.002	0.005	0.005	0.005	0.005	0.006	0.006	0.006	0.006	0.006	0.007
675	0.002	0.004	0.004	0.004	0.004	0.004	0.004	0.004	0.005	0.005	0.005
725	0.002	0.003	0.003	0.004	0.004	0.004	0.004	0.004	0.004	0.005	0.004
775	0.001	0.003	0.003	0.003	0.003	0.004	0.004	0.004	0.003	0.004	0.004
825	0.001	0.003	0.003	0.003	0.003	0.003	0.003	0.004	0.003	0.004	0.003
875	0.001	0.002	0.002	0.003	0.003	0.003	0.003	0.003	0.003	0.003	0.003
925	0.001	0.002	0.002	0.003	0.003	0.003	0.003	0.003	0.002	0.003	0.003
975	0.001	0.002	0.002	0.002	0.002	0.003	0.002	0.003	0.002	0.003	0.002
1025	0.001	0.002	0.002	0.002	0.002	0.003	0.002	0.002	0.002	0.003	0.002
1075	0.001	0.002	0.002	0.002	0.002	0.003	0.002	0.002	0.002	0.003	0.002
1125	0.001	0.002	0.002	0.002	0.002	0.002	0.002	0.002	0.002	0.003	0.002
1175	0.001	0.002	0.002	0.002	0.002	0.002	0.002	0.002	0.002	0.003	0.002
1225	0.001	0.002	0.002	0.002	0.002	0.002	0.002	0.002	0.002	0.003	0.003
1275	0.001	0.002	0.002	0.002	0.002	0.002	0.002	0.002	0.002	0.002	0.002
1325	0.001	0.002	0.002	0.002	0.002	0.002	0.002	0.002	0.002	0.003	0.002
1375	0.001	0.002	0.002	0.002	0.002	0.002	0.002	0.002	0.002	0.003	0.002
1425	0.001	0.002	0.002	0.002	0.002	0.002	0.002	0.002	0.002	0.002	0.002
1475	0.001	0.002	0.002	0.002	0.002	0.002	0.002	0.002	0.002	0.003	0.002
1525	0.001	0.002	0.002	0.002	0.002	0.002	0.002	0.002	0.002	0.003	0.002
1575	0.001	0.002	0.002	0.002	0.002	0.002	0.002	0.002	0.002	0.003	0.002
1625	0.001	0.002	0.002	0.002	0.002	0.002	0.002	0.002	0.002	0.003	0.002
1675	0.001	0.002	0.002	0.002	0.002	0.002	0.002	0.002	0.002	0.003	0.002
1725	0.001	0.002	0.002	0.002	0.002	0.002	0.002	0.002	0.002	0.003	0.002
1775	0.001	0.002	0.002	0.002	0.002	0.002	0.002	0.002	0.002	0.003	0.003
1825	0.020	0.007	0.005	0.005	0.004	0.004	0.005	0.005	0.006	0.006	0.007
1875	0.014	0.018	0.016	0.016	0.018	0.018	0.017	0.017	0.018	0.019	0.020
1925	0.006	0.006	0.005	0.005	0.004	0.006	0.006	0.006	0.007	0.009	0.011
1975	0.021	0.008	0.005	0.005	0.005	0.005	0.005	0.006	0.006	0.007	0.007

5.2.4	TABLE: Harmonics and inter-harmonics (According to DIN EN 61000-4-7 )										
Model: SOFAR 20000TL-G2											
Active power P/P <sub>n</sub> [%]	0	10	20	30	40	50	60	70	80	90	100
Frequency [kHz]	[%]	[%]	[%]	[%]	[%]	[%]	[%]	[%]	[%]	[%]	[%]
2.1	0.008	0.019	0.022	0.020	0.020	0.021	0.023	0.023	0.026	0.027	0.030
2.3	0.009	0.026	0.030	0.031	0.032	0.033	0.032	0.030	0.030	0.029	0.030
2.5	0.010	0.029	0.031	0.030	0.031	0.034	0.034	0.034	0.034	0.033	0.033
2.7	0.010	0.028	0.031	0.033	0.034	0.035	0.033	0.033	0.034	0.034	0.033
2.9	0.009	0.030	0.031	0.033	0.032	0.034	0.035	0.036	0.036	0.037	0.037
3.1	0.010	0.027	0.025	0.027	0.027	0.027	0.028	0.030	0.034	0.033	0.034
3.3	0.009	0.023	0.019	0.021	0.020	0.021	0.022	0.025	0.028	0.027	0.031
3.5	0.009	0.023	0.021	0.022	0.022	0.022	0.022	0.023	0.024	0.026	0.028
3.7	0.009	0.020	0.016	0.017	0.016	0.016	0.017	0.018	0.022	0.024	0.026
3.9	0.009	0.019	0.015	0.017	0.015	0.015	0.015	0.016	0.018	0.018	0.020
4.1	0.009	0.018	0.015	0.013	0.014	0.015	0.017	0.018	0.018	0.020	0.022
4.3	0.009	0.016	0.012	0.011	0.011	0.011	0.011	0.013	0.015	0.016	0.018
4.5	0.009	0.015	0.012	0.011	0.012	0.011	0.012	0.013	0.014	0.015	0.016
4.7	0.014	0.039	0.040	0.039	0.040	0.043	0.045	0.050	0.054	0.059	0.067
4.9	0.009	0.019	0.017	0.018	0.018	0.016	0.019	0.016	0.018	0.018	0.016
5.1	0.008	0.015	0.013	0.012	0.012	0.012	0.011	0.011	0.012	0.013	0.015
5.3	0.007	0.012	0.010	0.009	0.008	0.009	0.010	0.013	0.014	0.014	0.016
5.5	0.008	0.011	0.008	0.008	0.008	0.008	0.008	0.008	0.010	0.011	0.011
5.7	0.007	0.010	0.008	0.008	0.007	0.007	0.008	0.008	0.009	0.010	0.011
5.9	0.007	0.010	0.008	0.008	0.007	0.007	0.008	0.008	0.009	0.009	0.010
6.1	0.007	0.009	0.007	0.007	0.007	0.007	0.007	0.007	0.008	0.009	0.009
6.3	0.007	0.009	0.007	0.006	0.006	0.006	0.007	0.007	0.008	0.008	0.009
6.5	0.006	0.008	0.007	0.006	0.006	0.006	0.006	0.007	0.007	0.008	0.008
6.7	0.007	0.008	0.006	0.006	0.006	0.006	0.006	0.006	0.007	0.007	0.008
6.9	0.006	0.008	0.006	0.006	0.006	0.006	0.005	0.006	0.006	0.007	0.008
7.1	0.006	0.008	0.006	0.007	0.006	0.006	0.007	0.007	0.007	0.008	0.008
7.3	0.006	0.007	0.006	0.006	0.006	0.005	0.005	0.006	0.006	0.007	0.008
7.5	0.007	0.011	0.010	0.011	0.011	0.011	0.011	0.013	0.013	0.014	0.009
7.7	0.006	0.006	0.006	0.005	0.005	0.005	0.005	0.006	0.006	0.006	0.007
7.9	0.006	0.006	0.005	0.005	0.005	0.005	0.005	0.006	0.006	0.006	0.007
8.1	0.006	0.006	0.006	0.005	0.005	0.005	0.005	0.005	0.006	0.006	0.007
8.3	0.006	0.006	0.005	0.005	0.005	0.005	0.005	0.006	0.006	0.006	0.007
8.5	0.006	0.006	0.005	0.005	0.005	0.005	0.005	0.005	0.006	0.006	0.007
8.7	0.006	0.006	0.005	0.005	0.005	0.005	0.005	0.005	0.006	0.005	0.006
8.9	0.006	0.006	0.005	0.005	0.005	0.005	0.005	0.005	0.006	0.005	0.006

5.2.4	TABLE: Harmonics and inter-harmonics (according to DIN EN 61000-3-2) Model: SOFAR 25000TL-G2										P
Active power P/P <sub>n</sub> [%]	10	20	30	40	50	60	70	80	90	100	Limit [%]
Harmonic number	[%]	[%]	[%]	[%]	[%]	[%]	[%]	[%]	[%]	[%]	
2	0.054	0.051	0.052	0.052	0.057	0.066	0.069	0.074	0.081	0.081	8.00
3	0.109	0.077	0.097	0.107	0.125	0.164	0.182	0.206	0.220	0.227	21.60
4	0.018	0.021	0.030	0.039	0.041	0.037	0.032	0.029	0.028	0.032	4.00
5	0.169	0.057	0.090	0.162	0.282	0.457	0.557	0.658	0.734	0.801	10.70
6	0.013	0.012	0.013	0.014	0.012	0.010	0.011	0.013	0.012	0.014	2.67
7	0.181	0.059	0.076	0.136	0.267	0.443	0.547	0.648	0.724	0.790	7.20
8	0.012	0.015	0.017	0.017	0.013	0.011	0.011	0.012	0.014	0.014	2.00
9	0.045	0.054	0.055	0.064	0.079	0.100	0.103	0.107	0.105	0.113	3.80
10	0.014	0.011	0.006	0.007	0.018	0.023	0.025	0.026	0.030	0.028	1.60
11	0.349	0.199	0.110	0.116	0.177	0.238	0.277	0.317	0.340	0.364	3.10
12	0.011	0.006	0.005	0.010	0.009	0.010	0.011	0.012	0.012	0.010	1.33
13	0.308	0.167	0.111	0.103	0.096	0.148	0.181	0.207	0.226	0.244	2.00
14	0.007	0.005	0.006	0.010	0.014	0.017	0.018	0.020	0.021	0.021	--
15	0.041	0.014	0.034	0.027	0.041	0.038	0.038	0.036	0.033	0.036	--
16	0.008	0.007	0.005	0.009	0.013	0.010	0.008	0.009	0.009	0.009	--
17	0.319	0.199	0.149	0.117	0.116	0.127	0.151	0.183	0.207	0.221	--
18	0.009	0.007	0.005	0.003	0.003	0.005	0.005	0.006	0.005	0.006	--
19	0.231	0.153	0.124	0.105	0.094	0.109	0.120	0.142	0.167	0.187	--
20	0.006	0.004	0.003	0.003	0.004	0.004	0.004	0.003	0.004	0.005	--
21	0.016	0.009	0.019	0.015	0.012	0.014	0.011	0.017	0.016	0.020	--
22	0.005	0.003	0.003	0.004	0.004	0.004	0.004	0.005	0.005	0.005	--
23	0.144	0.105	0.105	0.094	0.088	0.073	0.082	0.094	0.102	0.113	--
24	0.008	0.004	0.004	0.004	0.004	0.004	0.003	0.004	0.005	0.004	--
25	0.079	0.081	0.074	0.080	0.081	0.079	0.081	0.096	0.104	0.106	--
26	0.004	0.003	0.004	0.004	0.003	0.003	0.004	0.006	0.005	0.007	--
27	0.013	0.018	0.010	0.012	0.015	0.017	0.013	0.011	0.014	0.017	--
28	0.003	0.002	0.002	0.002	0.005	0.004	0.005	0.005	0.005	0.005	--
29	0.023	0.047	0.044	0.061	0.066	0.079	0.081	0.089	0.097	0.104	--
30	0.003	0.002	0.002	0.003	0.003	0.002	0.002	0.002	0.002	0.003	--
31	0.021	0.042	0.025	0.052	0.060	0.069	0.069	0.070	0.076	0.083	--
32	0.003	0.002	0.004	0.003	0.003	0.003	0.002	0.002	0.003	0.003	--
33	0.012	0.013	0.010	0.012	0.013	0.008	0.009	0.011	0.010	0.013	--
34	0.003	0.002	0.002	0.002	0.003	0.002	0.002	0.003	0.003	0.003	--
35	0.019	0.046	0.010	0.040	0.055	0.062	0.060	0.064	0.064	0.068	--
36	0.002	0.002	0.002	0.002	0.003	0.002	0.002	0.002	0.002	0.002	--
37	0.029	0.063	0.008	0.020	0.038	0.057	0.060	0.074	0.076	0.073	--
38	0.003	0.002	0.002	0.003	0.003	0.002	0.002	0.002	0.002	0.002	--
39	0.009	0.009	0.007	0.015	0.007	0.006	0.008	0.010	0.010	0.013	--
40	0.002	0.002	0.002	0.002	0.003	0.002	0.002	0.002	0.004	0.004	--

<b>5.2.4 TABLE: Harmonics and inter-harmonics (According to DIN EN 61000-4-7 )</b>											
<b>Model: SOFAR 25000TL-G2</b>											
Active power P/Pn [%]	0	10	20	30	40	50	60	70	80	90	100
Frequency [Hz]	[%]	[%]	[%]	[%]	[%]	[%]	[%]	[%]	[%]	[%]	[%]
75	0.006	0.024	0.023	0.022	0.020	0.020	0.020	0.022	0.022	0.023	0.025
125	0.008	0.034	0.037	0.038	0.035	0.034	0.032	0.032	0.033	0.032	0.035
175	0.008	0.035	0.035	0.038	0.037	0.038	0.038	0.038	0.038	0.037	0.036
225	0.008	0.035	0.034	0.036	0.036	0.036	0.037	0.038	0.038	0.038	0.039
275	0.008	0.028	0.029	0.031	0.030	0.031	0.032	0.036	0.037	0.039	0.040
325	0.008	0.027	0.024	0.024	0.024	0.024	0.025	0.029	0.031	0.034	0.036
375	0.007	0.022	0.018	0.018	0.019	0.018	0.019	0.022	0.026	0.027	0.030
425	0.006	0.018	0.016	0.015	0.015	0.016	0.017	0.019	0.021	0.023	0.026
475	0.006	0.017	0.015	0.014	0.014	0.015	0.014	0.016	0.019	0.020	0.022
525	0.006	0.016	0.012	0.011	0.010	0.011	0.011	0.013	0.014	0.015	0.017
575	0.006	0.013	0.010	0.010	0.010	0.011	0.012	0.013	0.014	0.015	0.019
625	0.006	0.014	0.010	0.010	0.010	0.010	0.009	0.010	0.012	0.012	0.013
675	0.006	0.012	0.008	0.008	0.008	0.008	0.008	0.010	0.010	0.011	0.012
725	0.005	0.011	0.007	0.008	0.008	0.008	0.008	0.008	0.010	0.010	0.011
775	0.005	0.010	0.007	0.007	0.007	0.008	0.007	0.008	0.009	0.010	0.011
825	0.005	0.011	0.007	0.006	0.006	0.007	0.008	0.009	0.008	0.010	0.012
875	0.006	0.010	0.007	0.007	0.008	0.009	0.008	0.009	0.010	0.011	0.011
925	0.006	0.010	0.008	0.008	0.008	0.008	0.007	0.008	0.009	0.009	0.010
975	0.005	0.009	0.007	0.006	0.006	0.006	0.007	0.007	0.008	0.008	0.009
1025	0.005	0.008	0.007	0.006	0.006	0.007	0.007	0.007	0.008	0.008	0.009
1075	0.005	0.007	0.006	0.005	0.006	0.006	0.006	0.006	0.007	0.007	0.008
1125	0.005	0.008	0.005	0.005	0.005	0.005	0.005	0.006	0.006	0.006	0.008
1175	0.005	0.007	0.005	0.005	0.005	0.005	0.005	0.006	0.006	0.006	0.007
1225	0.004	0.007	0.006	0.006	0.007	0.007	0.009	0.009	0.009	0.010	0.011
1275	0.005	0.007	0.005	0.005	0.005	0.006	0.006	0.007	0.008	0.009	0.011
1325	0.004	0.007	0.006	0.006	0.006	0.006	0.006	0.007	0.008	0.008	0.010
1375	0.004	0.006	0.005	0.005	0.005	0.005	0.005	0.006	0.007	0.008	0.010
1425	0.004	0.006	0.006	0.005	0.005	0.006	0.005	0.006	0.006	0.007	0.007
1475	0.005	0.005	0.005	0.004	0.004	0.005	0.005	0.005	0.006	0.005	0.006
1525	0.004	0.005	0.005	0.004	0.004	0.005	0.005	0.005	0.006	0.005	0.006
1575	0.004	0.005	0.005	0.005	0.005	0.005	0.005	0.006	0.006	0.006	0.007
1625	0.003	0.005	0.005	0.004	0.004	0.005	0.005	0.005	0.006	0.005	0.006
1675	0.004	0.004	0.005	0.005	0.004	0.005	0.005	0.005	0.006	0.005	0.006
1725	0.003	0.005	0.004	0.004	0.004	0.004	0.004	0.005	0.005	0.005	0.005
1775	0.004	0.004	0.004	0.004	0.004	0.004	0.004	0.005	0.005	0.005	0.006
1825	0.003	0.004	0.004	0.004	0.004	0.004	0.004	0.004	0.005	0.005	0.005
1875	0.003	0.004	0.004	0.004	0.004	0.004	0.004	0.004	0.005	0.005	0.005
1925	0.003	0.004	0.004	0.004	0.004	0.004	0.004	0.004	0.005	0.005	0.005
1975	0.003	0.004	0.004	0.004	0.004	0.004	0.004	0.004	0.005	0.005	0.005

5.2.4	TABLE: Harmonics and inter-harmonics (According to DIN EN 61000-4-7 )										
Model: SOFAR 25000TL-G2											
Active power P/P <sub>n</sub> [%]	0	10	20	30	40	50	60	70	80	90	100
Frequency [kHz]	[%]	[%]	[%]	[%]	[%]	[%]	[%]	[%]	[%]	[%]	[%]
2.1	0.005	0.003	0.003	0.003	0.004	0.003	0.003	0.003	0.004	0.004	0.004
2.3	0.009	0.014	0.014	0.014	0.014	0.015	0.014	0.014	0.014	0.014	0.015
2.5	0.007	0.004	0.003	0.003	0.004	0.004	0.004	0.004	0.004	0.005	0.005
2.7	0.003	0.005	0.003	0.003	0.004	0.004	0.004	0.004	0.004	0.004	0.004
2.9	0.003	0.005	0.004	0.004	0.004	0.004	0.004	0.004	0.005	0.005	0.005
3.1	0.002	0.005	0.005	0.005	0.005	0.005	0.005	0.006	0.006	0.005	0.006
3.3	0.004	0.009	0.008	0.008	0.008	0.008	0.008	0.008	0.008	0.008	0.008
3.5	0.005	0.009	0.009	0.009	0.010	0.011	0.011	0.011	0.010	0.011	0.010
3.7	0.003	0.009	0.008	0.009	0.010	0.011	0.012	0.012	0.013	0.014	0.011
3.9	0.007	0.014	0.016	0.017	0.018	0.019	0.020	0.020	0.022	0.023	0.024
4.1	0.008	0.015	0.015	0.016	0.016	0.017	0.017	0.018	0.019	0.021	0.021
4.3	0.002	0.005	0.004	0.004	0.004	0.005	0.004	0.004	0.005	0.005	0.005
4.5	0.001	0.004	0.003	0.003	0.004	0.004	0.004	0.004	0.004	0.004	0.004
4.7	0.001	0.003	0.003	0.003	0.003	0.004	0.004	0.004	0.004	0.004	0.004
4.9	0.001	0.002	0.003	0.003	0.003	0.003	0.003	0.003	0.003	0.003	0.003
5.1	0.001	0.002	0.002	0.003	0.002	0.003	0.002	0.003	0.002	0.003	0.003
5.3	0.001	0.002	0.002	0.002	0.002	0.003	0.002	0.003	0.002	0.003	0.003
5.5	0.001	0.002	0.002	0.002	0.002	0.003	0.002	0.002	0.002	0.003	0.003
5.7	0.001	0.002	0.002	0.002	0.002	0.002	0.002	0.002	0.002	0.002	0.002
5.9	0.001	0.002	0.002	0.002	0.002	0.002	0.002	0.002	0.002	0.002	0.002
6.1	0.001	0.002	0.002	0.002	0.002	0.002	0.002	0.002	0.002	0.002	0.002
6.3	0.001	0.002	0.002	0.002	0.002	0.002	0.002	0.002	0.002	0.002	0.002
6.5	0.001	0.002	0.002	0.002	0.002	0.002	0.002	0.002	0.002	0.002	0.002
6.7	0.001	0.001	0.002	0.002	0.002	0.002	0.002	0.002	0.001	0.002	0.002
6.9	0.001	0.001	0.001	0.002	0.002	0.002	0.002	0.002	0.001	0.002	0.002
7.1	0.001	0.002	0.002	0.002	0.002	0.002	0.002	0.002	0.002	0.002	0.002
7.3	0.001	0.001	0.001	0.002	0.002	0.002	0.002	0.002	0.001	0.002	0.002
7.5	0.001	0.001	0.001	0.002	0.002	0.002	0.002	0.002	0.001	0.002	0.002
7.7	0.001	0.001	0.001	0.002	0.002	0.002	0.002	0.001	0.001	0.002	0.002
7.9	0.001	0.001	0.001	0.002	0.002	0.002	0.002	0.002	0.001	0.002	0.002
8.1	0.001	0.002	0.002	0.002	0.002	0.002	0.002	0.002	0.002	0.003	0.002
8.3	0.001	0.001	0.001	0.002	0.002	0.002	0.001	0.001	0.002	0.002	0.002
8.5	0.001	0.001	0.001	0.002	0.002	0.002	0.002	0.001	0.002	0.002	0.001
8.7	0.001	0.001	0.001	0.002	0.002	0.002	0.001	0.001	0.002	0.002	0.001
8.9	0.001	0.001	0.001	0.002	0.002	0.002	0.001	0.001	0.002	0.002	0.002

5.2.4	TABLE: Harmonics and inter-harmonics (according to DIN EN 61000-3-2) Model: SOFAR 30000TL-G2										P
Active power P/P <sub>n</sub> [%]	10	20	30	40	50	60	70	80	90	100	Limit [%]
Harmonic number	[%]	[%]	[%]	[%]	[%]	[%]	[%]	[%]	[%]	[%]	
2	0.0373	0.0367	0.0440	0.0475	0.0572	0.0580	0.0612	0.0507	0.0425	0.0408	8.00
3	0.1002	0.0626	0.0734	0.0950	0.1508	0.1288	0.1796	0.1457	0.1591	0.1418	21.60
4	0.0023	0.0111	0.0244	0.0305	0.0178	0.0261	0.0250	0.0305	0.0276	0.0347	4.00
5	0.1335	0.0278	0.1108	0.2365	0.3934	0.4113	0.5111	0.5119	0.5950	0.6189	10.70
6	0.0081	0.0096	0.0077	0.0046	0.0101	0.0068	0.0100	0.0126	0.0093	0.0096	2.67
7	0.1063	0.0399	0.1044	0.2324	0.3383	0.4522	0.5233	0.5489	0.5887	0.6217	7.20
8	0.0059	0.0033	0.0079	0.0077	0.0070	0.0095	0.0132	0.0039	0.0061	0.0188	2.00
9	0.0559	0.0167	0.0531	0.0683	0.0859	0.0925	0.1075	0.0691	0.0981	0.0873	3.80
10	0.0146	0.0035	0.0027	0.0149	0.0187	0.0140	0.0165	0.0191	0.0215	0.0216	1.60
11	0.2485	0.1338	0.0991	0.1561	0.2016	0.2758	0.2968	0.3258	0.3403	0.3732	3.10
12	0.0096	0.0040	0.0067	0.0034	0.0074	0.0053	0.0031	0.0042	0.0062	0.0024	1.33
13	0.2297	0.1010	0.0902	0.0807	0.1340	0.1948	0.1937	0.2283	0.2371	0.2629	2.00
14	0.0040	0.0062	0.0071	0.0106	0.0139	0.0170	0.0093	0.0117	0.0141	0.0177	--
15	0.0084	0.0190	0.0204	0.0464	0.0533	0.0144	0.0274	0.0220	0.0305	0.0248	--
16	0.0031	0.0022	0.0047	0.0101	0.0081	0.0079	0.0091	0.0056	0.0050	0.0076	--
17	0.2342	0.1253	0.0952	0.0761	0.0836	0.1219	0.1449	0.1635	0.1520	0.1453	--
18	0.0036	0.0080	0.0025	0.0024	0.0045	0.0046	0.0071	0.0039	0.0028	0.0036	--
19	0.1733	0.0979	0.0819	0.0665	0.0783	0.1026	0.1233	0.1563	0.1448	0.1508	--
20	0.0047	0.0012	0.0020	0.0009	0.0031	0.0053	0.0011	0.0018	0.0047	0.0071	--
21	0.0041	0.0119	0.0059	0.0138	0.0111	0.0209	0.0099	0.0143	0.0100	0.0077	--
22	0.0005	0.0024	0.0035	0.0016	0.0019	0.0031	0.0016	0.0042	0.0029	0.0031	--
23	0.1132	0.0675	0.0704	0.0600	0.0511	0.0826	0.0820	0.1073	0.1038	0.1172	--
24	0.0016	0.0026	0.0022	0.0023	0.0020	0.0027	0.0012	0.0017	0.0011	0.0011	--
25	0.0782	0.0430	0.0601	0.0592	0.0580	0.0717	0.0776	0.0803	0.0837	0.0929	--
26	0.0030	0.0046	0.0029	0.0025	0.0032	0.0030	0.0024	0.0030	0.0035	0.0062	--
27	0.0152	0.0135	0.0077	0.0159	0.0283	0.0095	0.0134	0.0063	0.0229	0.0196	--
28	0.0009	0.0027	0.0010	0.0043	0.0016	0.0037	0.0052	0.0028	0.0054	0.0048	--
29	0.0553	0.0141	0.0435	0.0510	0.0540	0.0675	0.0702	0.0851	0.0724	0.0682	--
30	0.0020	0.0008	0.0031	0.0016	0.0010	0.0021	0.0022	0.0026	0.0009	0.0011	--
31	0.0716	0.0161	0.0414	0.0516	0.0514	0.0522	0.0636	0.0758	0.0734	0.0789	--
32	0.0006	0.0032	0.0037	0.0007	0.0036	0.0017	0.0012	0.0014	0.0031	0.0023	--
33	0.0212	0.0128	0.0084	0.0106	0.0108	0.0194	0.0051	0.0128	0.0057	0.0099	--
34	0.0020	0.0008	0.0023	0.0020	0.0006	0.0007	0.0022	0.0022	0.0018	0.0021	--
35	0.0707	0.0145	0.0247	0.0440	0.0419	0.0512	0.0515	0.0645	0.0615	0.0692	--
36	0.0014	0.0023	0.0009	0.0011	0.0010	0.0009	0.0011	0.0044	0.0008	0.0022	--
37	0.0710	0.0127	0.0138	0.0405	0.0467	0.0511	0.0570	0.0611	0.0585	0.0633	--
38	0.0011	0.0019	0.0039	0.0016	0.0012	0.0027	0.0013	0.0017	0.0015	0.0040	--
39	0.0098	0.0042	0.0134	0.0042	0.0132	0.0072	0.0051	0.0034	0.0142	0.0125	--
40	0.0014	0.0009	0.0008	0.0027	0.0013	0.0013	0.0020	0.0031	0.0036	0.0034	--



<b>5.2.4 TABLE: Harmonics and inter-harmonics (According to DIN EN 61000-4-7 )</b>											
<b>Model: SOFAR 3000TL-G2</b>											
Active power P/Pn [%]	0	10	20	30	40	50	60	70	80	90	100
Frequency [Hz]	[%]	[%]	[%]	[%]	[%]	[%]	[%]	[%]	[%]	[%]	[%]
75	0.1629	0.2448	0.2560	0.2524	0.2507	0.2438	0.2415	0.1341	0.0550	0.0346	0.1629
125	0.0868	0.0975	0.0874	0.0863	0.0737	0.0743	0.0722	0.0491	0.0390	0.0398	0.0868
175	0.2262	0.2139	0.2274	0.2578	0.2719	0.2781	0.2831	0.2809	0.1037	0.0316	0.2262
225	0.0806	0.1025	0.0905	0.0936	0.0829	0.0818	0.0807	0.0661	0.0496	0.0964	0.0806
275	0.1328	0.1746	0.1803	0.1892	0.1977	0.2013	0.2031	0.2005	0.1088	0.0352	0.1328
325	0.0297	0.0363	0.0329	0.0369	0.0356	0.0406	0.0433	0.0375	0.0330	0.1299	0.0297
375	0.0384	0.0439	0.0464	0.0516	0.0465	0.0496	0.0520	0.0664	0.0430	0.0239	0.0384
425	0.0287	0.0315	0.0262	0.0274	0.0277	0.0299	0.0329	0.0288	0.0218	0.0563	0.0287
475	0.0293	0.0337	0.0292	0.0267	0.0237	0.0258	0.0271	0.0327	0.0244	0.0189	0.0293
525	0.0209	0.0191	0.0188	0.0198	0.0187	0.0195	0.0213	0.0176	0.0155	0.0301	0.0209
575	0.0183	0.0213	0.0199	0.0190	0.0180	0.0182	0.0185	0.0175	0.0155	0.0145	0.0183
625	0.0150	0.0164	0.0170	0.0185	0.0200	0.0225	0.0251	0.0155	0.0117	0.0164	0.0150
675	0.0161	0.0163	0.0162	0.0156	0.0147	0.0162	0.0173	0.0181	0.0193	0.0121	0.0161
725	0.0149	0.0150	0.0189	0.0195	0.0193	0.0197	0.0194	0.0169	0.0119	0.0213	0.0149
775	0.0144	0.0150	0.0164	0.0153	0.0141	0.0157	0.0177	0.0167	0.0188	0.0107	0.0144
825	0.0148	0.0119	0.0128	0.0138	0.0123	0.0131	0.0147	0.0131	0.0102	0.0222	0.0148
875	0.0107	0.0113	0.0123	0.0116	0.0109	0.0116	0.0126	0.0119	0.0143	0.0095	0.0107
925	0.0115	0.0100	0.0096	0.0106	0.0094	0.0103	0.0111	0.0108	0.0095	0.0155	0.0115
975	0.0100	0.0099	0.0107	0.0102	0.0092	0.0101	0.0110	0.0097	0.0093	0.0084	0.0100
1025	0.0117	0.0107	0.0099	0.0097	0.0095	0.0100	0.0110	0.0103	0.0082	0.0102	0.0117
1075	0.0089	0.0095	0.0109	0.0105	0.0098	0.0100	0.0110	0.0096	0.0079	0.0072	0.0089
1125	0.1629	0.2448	0.2560	0.2524	0.2507	0.2438	0.2415	0.1341	0.0550	0.0346	0.1629
1175	0.0868	0.0975	0.0874	0.0863	0.0737	0.0743	0.0722	0.0491	0.0390	0.0398	0.0868
1225	0.0040	0.0050	0.0040	0.0040	0.0060	0.0070	0.0070	0.0070	0.0070	0.0080	0.0040
1275	0.0050	0.0040	0.0050	0.0050	0.0060	0.0070	0.0080	0.0090	0.0120	0.0160	0.0050
1325	0.0040	0.0040	0.0040	0.0040	0.0050	0.0050	0.0060	0.0070	0.0090	0.0120	0.0040
1375	0.0040	0.0040	0.0040	0.0040	0.0050	0.0050	0.0070	0.0090	0.0110	0.0150	0.0040
1425	0.0040	0.0040	0.0040	0.0040	0.0050	0.0050	0.0060	0.0060	0.0060	0.0080	0.0040
1475	0.0040	0.0030	0.0030	0.0030	0.0040	0.0040	0.0040	0.0050	0.0050	0.0060	0.0040
1525	0.0040	0.0030	0.0030	0.0030	0.0040	0.0040	0.0040	0.0040	0.0050	0.0050	0.0040
1575	0.0040	0.0030	0.0030	0.0040	0.0040	0.0040	0.0050	0.0050	0.0050	0.0060	0.0040
1625	0.0040	0.0030	0.0030	0.0030	0.0040	0.0040	0.0040	0.0040	0.0050	0.0050	0.0040
1675	0.0040	0.0030	0.0030	0.0040	0.0040	0.0040	0.0040	0.0040	0.0050	0.0050	0.0040
1725	0.0040	0.0030	0.0030	0.0030	0.0040	0.0040	0.0040	0.0040	0.0050	0.0050	0.0040
1775	0.0040	0.0030	0.0030	0.0030	0.0040	0.0040	0.0040	0.0040	0.0050	0.0040	0.0040
1825	0.0030	0.0030	0.0030	0.0030	0.0040	0.0040	0.0040	0.0040	0.0040	0.0040	0.0030
1875	0.0030	0.0030	0.0030	0.0030	0.0030	0.0040	0.0040	0.0040	0.0040	0.0040	0.0030
1925	0.0030	0.0030	0.0030	0.0030	0.0040	0.0040	0.0040	0.0040	0.0040	0.0040	0.0030
1975	0.0030	0.0030	0.0030	0.0030	0.0030	0.0040	0.0040	0.0030	0.0040	0.0040	0.0030

5.2.4	TABLE: Harmonics and inter-harmonics (According to DIN EN 61000-4-7 )										
Model: SOFAR 30000TL-G2											
Active power P/P <sub>n</sub> [%]	0	10	20	30	40	50	60	70	80	90	100
Frequency [kHz]	[%]	[%]	[%]	[%]	[%]	[%]	[%]	[%]	[%]	[%]	[%]
2.1	0.0121	0.0167	0.0205	0.0224	0.0273	0.0367	0.0254	0.0319	0.0208	0.0180	0.0229
2.3	0.0121	0.0281	0.0215	0.0278	0.0185	0.0268	0.0252	0.0299	0.0232	0.0235	0.0226
2.5	0.0144	0.0287	0.0252	0.0245	0.0213	0.0366	0.0203	0.0240	0.0229	0.0242	0.0238
2.7	0.0172	0.0224	0.0214	0.0223	0.0251	0.0244	0.0218	0.0237	0.0149	0.0194	0.0228
2.9	0.0142	0.0130	0.0131	0.0182	0.0160	0.0187	0.0201	0.0159	0.0207	0.0196	0.0197
3.1	0.0100	0.0136	0.0175	0.0170	0.0087	0.0168	0.0199	0.0222	0.0102	0.0198	0.0240
3.3	0.0114	0.0134	0.0141	0.0135	0.0186	0.0166	0.0140	0.0179	0.0252	0.0193	0.0279
3.5	0.0083	0.0130	0.0096	0.0117	0.0070	0.0094	0.0108	0.0148	0.0098	0.0141	0.0242
3.7	0.0111	0.0116	0.0055	0.0052	0.0118	0.0110	0.0081	0.0128	0.0109	0.0088	0.0126
3.9	0.0185	0.0129	0.0088	0.0069	0.0089	0.0093	0.0094	0.0116	0.0162	0.0164	0.0141
4.1	0.0153	0.0122	0.0069	0.0075	0.0061	0.0070	0.0072	0.0114	0.0100	0.0094	0.0108
4.3	0.0131	0.0106	0.0059	0.0077	0.0069	0.0085	0.0068	0.0087	0.0089	0.0093	0.0119
4.5	0.0093	0.0100	0.0065	0.0047	0.0051	0.0080	0.0049	0.0070	0.0072	0.0119	0.0107
4.7	0.0070	0.0103	0.0068	0.0071	0.0054	0.0045	0.0051	0.0072	0.0077	0.0075	0.0088
4.9	0.0123	0.0109	0.0069	0.0054	0.0079	0.0055	0.0082	0.0076	0.0094	0.0140	0.0115
5.1	0.0176	0.0091	0.0071	0.0062	0.0069	0.0071	0.0055	0.0075	0.0064	0.0077	0.0090
5.3	0.0139	0.0067	0.0055	0.0055	0.0062	0.0063	0.0051	0.0080	0.0051	0.0095	0.0076
5.5	0.0126	0.0084	0.0050	0.0045	0.0059	0.0077	0.0055	0.0060	0.0048	0.0095	0.0054
5.7	0.0068	0.0065	0.0054	0.0037	0.0044	0.0054	0.0068	0.0041	0.0049	0.0053	0.0060
5.9	0.0073	0.0082	0.0039	0.0032	0.0049	0.0051	0.0040	0.0046	0.0063	0.0073	0.0071
6.1	0.0079	0.0070	0.0040	0.0049	0.0029	0.0043	0.0044	0.0066	0.0052	0.0057	0.0092
6.3	0.0164	0.0087	0.0055	0.0042	0.0038	0.0061	0.0036	0.0054	0.0050	0.0050	0.0053
6.5	0.0123	0.0084	0.0052	0.0062	0.0078	0.0077	0.0086	0.0071	0.0092	0.0074	0.0061
6.7	0.0113	0.0067	0.0075	0.0044	0.0047	0.0058	0.0079	0.0054	0.0088	0.0116	0.0224
6.9	0.0067	0.0058	0.0058	0.0042	0.0054	0.0034	0.0030	0.0039	0.0070	0.0080	0.0084
7.1	0.0088	0.0066	0.0043	0.0019	0.0041	0.0044	0.0063	0.0076	0.0097	0.0117	0.0068
7.3	0.0068	0.0059	0.0043	0.0031	0.0042	0.0038	0.0047	0.0053	0.0055	0.0055	0.0106
7.5	0.0135	0.0062	0.0038	0.0032	0.0047	0.0042	0.0046	0.0031	0.0049	0.0045	0.0068
7.7	0.0098	0.0049	0.0038	0.0043	0.0054	0.0044	0.0047	0.0033	0.0042	0.0070	0.0043
7.9	0.0101	0.0060	0.0038	0.0034	0.0043	0.0042	0.0043	0.0037	0.0062	0.0059	0.0065
8.1	0.0066	0.0061	0.0038	0.0031	0.0036	0.0041	0.0042	0.0033	0.0045	0.0048	0.0043
8.3	0.0053	0.0060	0.0036	0.0032	0.0047	0.0035	0.0047	0.0042	0.0041	0.0037	0.0044
8.5	0.0076	0.0047	0.0029	0.0030	0.0047	0.0053	0.0038	0.0038	0.0031	0.0037	0.0053
8.7	0.0119	0.0053	0.0039	0.0037	0.0028	0.0042	0.0044	0.0030	0.0034	0.0040	0.0052
8.9	0.0049	0.0071	0.0032	0.0028	0.0027	0.0044	0.0036	0.0038	0.0042	0.0046	0.0043

5.2.4	TABLE: Harmonics and inter-harmonics (according to DIN EN 61000-3-2) Model: SOFAR 33000TL-G2										P
Active power P/P <sub>n</sub> [%]	10	20	30	40	50	60	70	80	90	100	Limit [%]
Harmonic number	[%]	[%]	[%]	[%]	[%]	[%]	[%]	[%]	[%]	[%]	
2	0.036	0.034	0.036	0.042	0.046	0.049	0.049	0.049	0.044	0.071	8.00
3	0.073	0.068	0.081	0.102	0.120	0.138	0.139	0.135	0.131	0.161	21.60
4	0.011	0.017	0.025	0.025	0.020	0.020	0.021	0.022	0.026	0.086	4.00
5	0.095	0.056	0.122	0.270	0.371	0.447	0.487	0.532	0.576	0.555	10.70
6	0.009	0.007	0.008	0.006	0.008	0.009	0.009	0.010	0.010	0.031	2.67
7	0.081	0.057	0.118	0.269	0.374	0.456	0.498	0.542	0.586	0.658	7.20
8	0.008	0.010	0.010	0.008	0.008	0.010	0.009	0.010	0.008	0.045	2.00
9	0.044	0.038	0.053	0.068	0.075	0.083	0.083	0.078	0.078	0.067	3.80
10	0.007	0.004	0.006	0.014	0.018	0.017	0.018	0.020	0.023	0.009	1.60
11	0.224	0.089	0.099	0.171	0.224	0.262	0.291	0.312	0.337	0.386	3.10
12	0.008	0.004	0.007	0.005	0.005	0.007	0.006	0.005	0.004	0.021	1.33
13	0.184	0.089	0.072	0.104	0.153	0.183	0.207	0.222	0.239	0.242	2.00
14	0.003	0.004	0.007	0.012	0.013	0.013	0.014	0.015	0.017	0.036	--
15	0.014	0.023	0.016	0.030	0.026	0.025	0.024	0.018	0.017	0.011	--
16	0.003	0.004	0.008	0.008	0.007	0.007	0.007	0.006	0.005	0.012	--
17	0.180	0.107	0.074	0.073	0.091	0.122	0.145	0.150	0.139	0.107	--
18	0.005	0.003	0.002	0.004	0.004	0.005	0.005	0.005	0.005	0.008	--
19	0.133	0.089	0.065	0.065	0.081	0.103	0.130	0.144	0.142	0.128	--
20	0.002	0.002	0.002	0.003	0.003	0.002	0.003	0.003	0.004	0.009	--
21	0.010	0.014	0.009	0.009	0.008	0.013	0.013	0.010	0.011	0.011	--
22	0.002	0.003	0.002	0.002	0.003	0.004	0.004	0.004	0.005	0.006	--
23	0.073	0.074	0.058	0.052	0.061	0.075	0.090	0.102	0.113	0.117	--
24	0.002	0.003	0.002	0.002	0.002	0.002	0.002	0.002	0.002	0.003	--
25	0.055	0.048	0.053	0.054	0.054	0.067	0.077	0.082	0.085	0.084	--
26	0.002	0.003	0.002	0.002	0.003	0.004	0.004	0.005	0.005	0.005	--
27	0.010	0.008	0.011	0.011	0.011	0.010	0.013	0.012	0.010	0.008	--
28	0.002	0.002	0.002	0.003	0.004	0.004	0.004	0.003	0.003	0.002	--
29	0.049	0.025	0.043	0.049	0.055	0.062	0.071	0.074	0.069	0.060	--
30	0.002	0.001	0.002	0.002	0.002	0.002	0.002	0.002	0.002	0.002	--
31	0.065	0.011	0.036	0.043	0.045	0.052	0.063	0.070	0.070	0.064	--
32	0.002	0.002	0.002	0.002	0.002	0.002	0.002	0.002	0.002	0.002	--
33	0.012	0.004	0.010	0.004	0.007	0.011	0.008	0.008	0.012	0.014	--
34	0.002	0.001	0.002	0.002	0.002	0.003	0.002	0.002	0.002	0.003	--
35	0.072	0.007	0.031	0.041	0.038	0.047	0.055	0.062	0.065	0.061	--
36	0.002	0.001	0.002	0.001	0.002	0.002	0.002	0.002	0.002	0.002	--
37	0.066	0.010	0.016	0.040	0.040	0.051	0.054	0.056	0.057	0.054	--
38	0.001	0.002	0.002	0.001	0.002	0.002	0.002	0.002	0.003	0.002	--
39	0.005	0.003	0.006	0.004	0.006	0.008	0.008	0.006	0.005	0.005	--
40	0.001	0.001	0.001	0.002	0.002	0.002	0.003	0.002	0.002	0.002	--

<b>5.2.4 TABLE: Harmonics and inter-harmonics (According to DIN EN 61000-4-7 )</b>											
<b>Model: SOFAR 33000TL-G2</b>											
Active power P/Pn [%]	0	10	20	30	40	50	60	70	80	90	100
Frequency [Hz]	[%]	[%]	[%]	[%]	[%]	[%]	[%]	[%]	[%]	[%]	[%]
75	0.009	0.017	0.015	0.013	0.013	0.015	0.015	0.016	0.017	0.016	0.018
125	0.008	0.022	0.023	0.023	0.023	0.023	0.023	0.022	0.020	0.022	0.022
175	0.008	0.023	0.025	0.024	0.022	0.022	0.023	0.022	0.021	0.020	0.020
225	0.010	0.021	0.023	0.023	0.022	0.023	0.023	0.022	0.020	0.020	0.020
275	0.009	0.019	0.021	0.020	0.021	0.023	0.023	0.023	0.021	0.021	0.021
325	0.009	0.016	0.017	0.017	0.017	0.020	0.021	0.021	0.020	0.020	0.021
375	0.008	0.012	0.014	0.013	0.013	0.016	0.017	0.018	0.018	0.019	0.020
425	0.006	0.012	0.013	0.013	0.013	0.015	0.017	0.018	0.018	0.020	0.022
475	0.006	0.009	0.011	0.010	0.009	0.011	0.013	0.014	0.015	0.016	0.017
525	0.007	0.009	0.009	0.008	0.009	0.011	0.011	0.013	0.013	0.014	0.016
575	0.008	0.009	0.009	0.008	0.008	0.010	0.011	0.012	0.013	0.015	0.016
625	0.008	0.007	0.007	0.006	0.006	0.008	0.008	0.009	0.010	0.011	0.012
675	0.007	0.007	0.006	0.006	0.006	0.007	0.008	0.008	0.009	0.010	0.011
725	0.006	0.006	0.006	0.005	0.006	0.007	0.007	0.008	0.008	0.009	0.010
775	0.006	0.006	0.006	0.005	0.006	0.007	0.007	0.007	0.007	0.008	0.009
825	0.007	0.008	0.007	0.007	0.006	0.008	0.008	0.009	0.008	0.011	0.011
875	0.007	0.006	0.005	0.005	0.005	0.006	0.007	0.007	0.008	0.008	0.009
925	0.007	0.006	0.005	0.005	0.005	0.006	0.007	0.007	0.007	0.008	0.008
975	0.007	0.005	0.005	0.004	0.004	0.005	0.006	0.006	0.006	0.007	0.007
1025	0.005	0.005	0.004	0.004	0.004	0.005	0.005	0.006	0.006	0.007	0.007
1075	0.005	0.005	0.004	0.004	0.004	0.005	0.005	0.006	0.006	0.006	0.007
1125	0.006	0.005	0.004	0.004	0.004	0.005	0.005	0.005	0.006	0.006	0.007
1175	0.006	0.004	0.004	0.004	0.004	0.005	0.005	0.005	0.006	0.005	0.006
1225	0.006	0.004	0.005	0.004	0.004	0.006	0.007	0.007	0.007	0.007	0.008
1275	0.007	0.005	0.004	0.005	0.005	0.006	0.007	0.008	0.009	0.012	0.016
1325	0.005	0.004	0.004	0.004	0.004	0.005	0.005	0.006	0.007	0.009	0.012
1375	0.005	0.004	0.004	0.004	0.004	0.005	0.005	0.007	0.009	0.011	0.015
1425	0.005	0.004	0.004	0.004	0.004	0.005	0.005	0.006	0.006	0.006	0.008
1475	0.006	0.004	0.003	0.003	0.003	0.004	0.004	0.004	0.005	0.005	0.006
1525	0.005	0.004	0.003	0.003	0.003	0.004	0.004	0.004	0.004	0.005	0.005
1575	0.005	0.004	0.003	0.003	0.004	0.004	0.004	0.005	0.005	0.005	0.006
1625	0.004	0.004	0.003	0.003	0.003	0.004	0.004	0.004	0.004	0.005	0.005
1675	0.004	0.004	0.003	0.003	0.004	0.004	0.004	0.004	0.004	0.005	0.005
1725	0.004	0.004	0.003	0.003	0.003	0.004	0.004	0.004	0.004	0.005	0.005
1775	0.005	0.004	0.003	0.003	0.003	0.004	0.004	0.004	0.004	0.005	0.004
1825	0.004	0.003	0.003	0.003	0.003	0.004	0.004	0.004	0.004	0.004	0.004
1875	0.004	0.003	0.003	0.003	0.003	0.003	0.004	0.004	0.004	0.004	0.004
1925	0.004	0.003	0.003	0.003	0.003	0.004	0.004	0.004	0.004	0.004	0.004
1975	0.004	0.003	0.003	0.003	0.003	0.003	0.004	0.004	0.003	0.004	0.004

5.2.4	TABLE: Harmonics and inter-harmonics (According to DIN EN 61000-4-7 )										
Model: SOFAR 33000TL-G2											
Active power P/P <sub>n</sub> [%]	0	10	20	30	40	50	60	70	80	90	100
Frequency [kHz]	[%]	[%]	[%]	[%]	[%]	[%]	[%]	[%]	[%]	[%]	[%]
2.1	0.008	0.003	0.002	0.002	0.002	0.003	0.002	0.003	0.002	0.003	0.003
2.3	0.014	0.011	0.011	0.011	0.011	0.011	0.011	0.011	0.011	0.012	0.012
2.5	0.007	0.003	0.003	0.003	0.003	0.004	0.004	0.004	0.004	0.005	0.005
2.7	0.005	0.003	0.002	0.002	0.002	0.003	0.003	0.003	0.002	0.003	0.003
2.9	0.005	0.003	0.003	0.003	0.003	0.003	0.004	0.004	0.003	0.003	0.003
3.1	0.005	0.003	0.003	0.003	0.004	0.005	0.004	0.004	0.003	0.004	0.003
3.3	0.007	0.006	0.006	0.006	0.006	0.006	0.006	0.006	0.005	0.005	0.004
3.5	0.006	0.006	0.006	0.008	0.008	0.008	0.008	0.007	0.006	0.005	0.005
3.7	0.005	0.006	0.007	0.008	0.008	0.010	0.010	0.008	0.007	0.006	0.006
3.9	0.010	0.012	0.013	0.014	0.014	0.016	0.017	0.018	0.018	0.020	0.021
4.1	0.009	0.012	0.012	0.012	0.013	0.014	0.014	0.015	0.017	0.018	0.019
4.3	0.002	0.004	0.003	0.003	0.003	0.004	0.004	0.004	0.004	0.004	0.004
4.5	0.002	0.003	0.003	0.003	0.003	0.003	0.003	0.003	0.003	0.004	0.003
4.7	0.002	0.003	0.002	0.002	0.002	0.003	0.002	0.003	0.002	0.003	0.003
4.9	0.001	0.002	0.002	0.002	0.002	0.002	0.002	0.002	0.002	0.003	0.002
5.1	0.001	0.002	0.002	0.002	0.002	0.002	0.002	0.002	0.002	0.002	0.002
5.3	0.001	0.002	0.002	0.002	0.002	0.002	0.002	0.002	0.002	0.002	0.002
5.5	0.001	0.002	0.002	0.002	0.002	0.002	0.002	0.002	0.002	0.002	0.002
5.7	0.001	0.001	0.002	0.002	0.002	0.002	0.002	0.001	0.002	0.002	0.002
5.9	0.001	0.001	0.002	0.002	0.002	0.002	0.002	0.001	0.002	0.002	0.002
6.1	0.001	0.001	0.001	0.002	0.002	0.002	0.001	0.001	0.002	0.002	0.002
6.3	0.001	0.001	0.001	0.002	0.001	0.002	0.001	0.001	0.002	0.002	0.001
6.5	0.001	0.001	0.001	0.002	0.001	0.002	0.001	0.001	0.002	0.002	0.001
6.7	0.001	0.001	0.001	0.001	0.001	0.001	0.001	0.001	0.002	0.002	0.001
6.9	0.001	0.001	0.001	0.002	0.001	0.001	0.001	0.001	0.002	0.002	0.002
7.1	0.001	0.001	0.001	0.002	0.002	0.002	0.001	0.001	0.002	0.002	0.002
7.3	0.001	0.001	0.001	0.001	0.001	0.001	0.001	0.001	0.002	0.001	0.001
7.5	0.001	0.001	0.001	0.001	0.001	0.001	0.001	0.001	0.001	0.001	0.001
7.7	0.001	0.001	0.001	0.001	0.001	0.001	0.001	0.001	0.001	0.001	0.001
7.9	0.001	0.001	0.001	0.001	0.001	0.002	0.001	0.001	0.002	0.002	0.002
8.1	0.001	0.002	0.002	0.002	0.002	0.002	0.002	0.002	0.002	0.002	0.002
8.3	0.001	0.001	0.001	0.001	0.001	0.001	0.001	0.001	0.001	0.001	0.001
8.5	0.001	0.001	0.001	0.001	0.001	0.001	0.001	0.001	0.001	0.001	0.001
8.7	0.001	0.001	0.001	0.001	0.001	0.001	0.001	0.001	0.001	0.001	0.001
8.9	0.001	0.001	0.001	0.001	0.001	0.001	0.001	0.001	0.001	0.001	0.001

5.2.5	Commutation notches	P		
$\hat{U}_n$ (The peak value of the nominal voltage $U_n$ ) = <u>325.22</u> V Test impedance: 0.24Ω +0.15j				
Operating points	Maximum commutation current (A)	$\Delta U_{kom}$ (V)	$d_{kom} (= \Delta U_{kom} / \hat{U}_n)$ (%)	$d_{kom}$ limit (%)
25% $P_{E_{max}}$ and 35 % $P_{E_{max}}$ :	1.938	0.548	0.169	5
65% $P_{E_{max}}$ and 75 % $P_{E_{max}}$ :	4.650	1.316	0.405	5
>90 % $P_{E_{max}}$ :	7.688	2.176	0.669	5

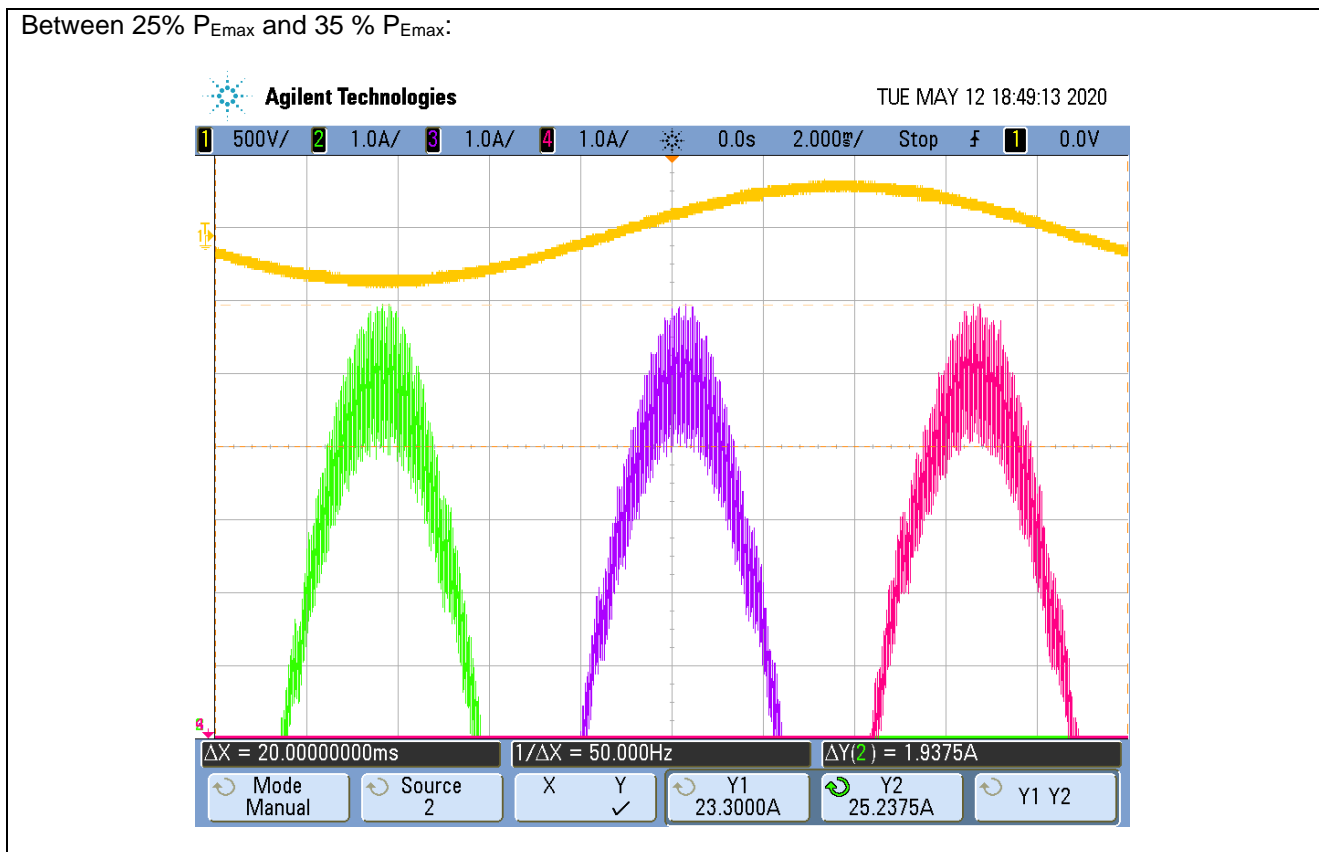

Between 65%  $P_{Emax}$  and 75 %  $P_{Emax}$ :

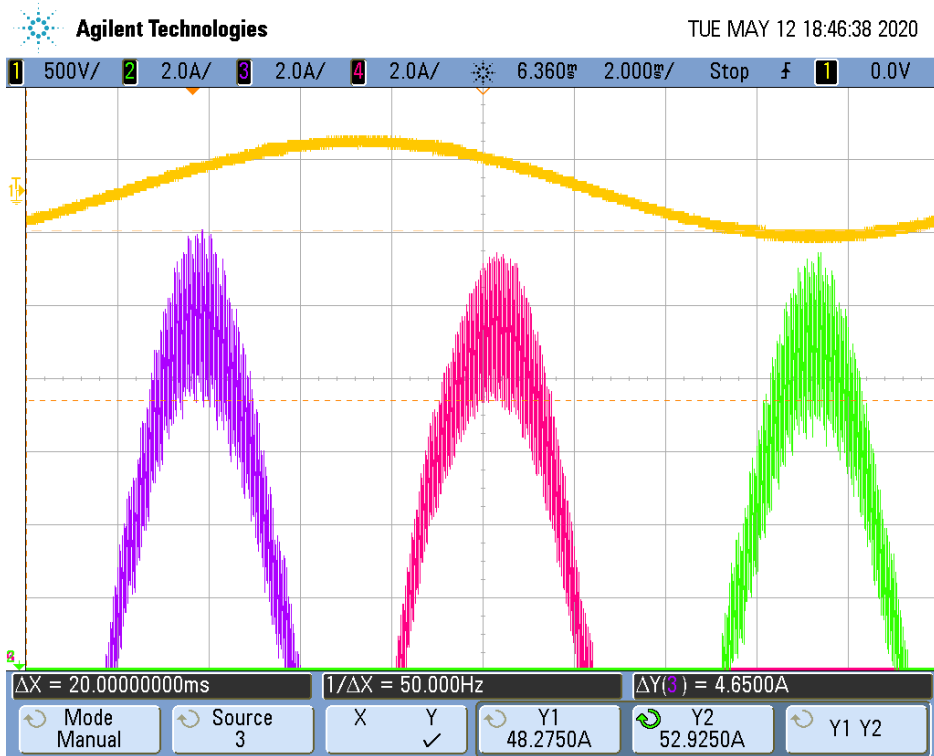

>90 %  $P_{Emax}$ :

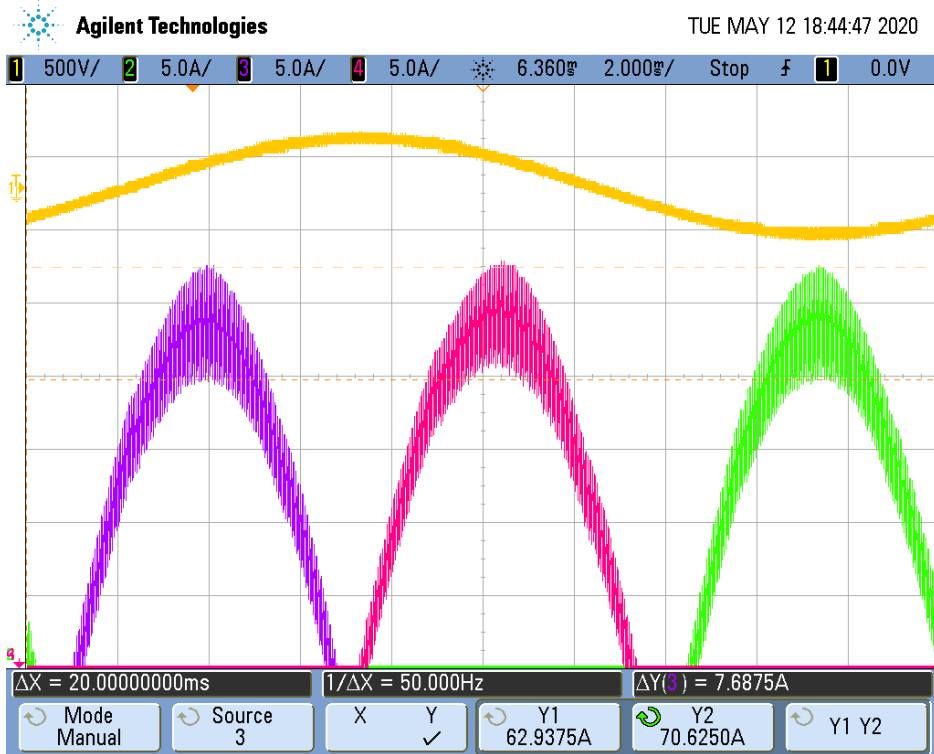

5.2.6	TABLE: DC Injection					P
Model: SOFAR 20000TL-G2						
Mains voltage: 230V						
Power P/Pn		100%				
Measurement						Limitation
Phase L1		Phase L2		Phase L3		
0.074A	0.255%	0.054A	0.186%	0.063A	0.217%	0.5%
Power P/Pn [%]		66%				
Measurement						Limitation
Phase L1		Phase L2		Phase L3		
0.087A	0.300%	0.054A	0.186%	0.076A	0.262%	0.5%
Power P/Pn [%]		33%				
Measurement						Limitation
Phase L1		Phase L2		Phase L3		
0.086A	0.297%	0.053A	0.183%	0.068A	0.235%	0.5%
Model: SOFAR 33000TL-G2						
Power P/Pn		100%				
Measurement						Limitation
Phase L1		Phase L2		Phase L3		
0.046A	0.096%	0.062A	0.130%	0.077A	0.161%	0.5%
Power P/Pn [%]		66%				
Measurement						Limitation
Phase L1		Phase L2		Phase L3		
0.062A	0.130%	0.030A	0.063%	0.067A	0.140%	0.5%
Power P/Pn [%]		33%				
Measurement						Limitation
Phase L1		Phase L2		Phase L3		
0.078A	0.163%	0.031A	0.065%	0.073A	0.153%	0.5%
Remark: The absolute value of measurements have been taken.						



5.3.2	TABLE: Asymmetry calculation for three-phase inverter						P
<input checked="" type="checkbox"/> Three-phase inverter							
Test voltage: 230 V, 50 Hz							
No	Test condition		Power asymmetry [VA]				
	$\cos\phi$	P/P <sub>E<sub>max</sub></sub>	I	II	III	IV	VI
1	1.00	100%	28.93	29.35	28.37	29.83	29.49
2	1.00	50%	22.72	22.48	22.64	22.84	22.59
3	max. under-excited	100%	35.46	36.32	36.84	35.26	34.76
4		50%	26.05	26.23	27.18	26.51	26.98
5	max. over-excited	100%	41.39	40.66	40.23	41.91	41.77
6		50%	36.30	36.30	36.28	35.89	35.59
Max. Power Asymmetry [VA]			41.91		Limitation [VA]		4600

5.4.2		TABLE: Measurement of active- and reactive power ranges						P
Model: SOFAR 20000TL-G2								
No.	Test condition		Measurement					
	CoS $\phi$	U / Un	U [V]	I [A]	P <sub>E<sub>max</sub>600 *</sub> [W]	S <sub>E<sub>max</sub>600 *</sub> [VA]	Q [Var]	CoS $\phi$
a1	1.00	90%	207.08	32.33	20068.16	20079.76	-628.33	0.9994
a3		100%	229.97	29.24	20161.79	20170.24	-583.65	0.9996
a5		109%	250.79	26.87	20213.37	20221.10	-558.81	0.9996
b1	max. under-excited	95%	218.81	27.24	17862.33	19879.62	-8725.59	0.8985
b3		100%	229.75	31.91	19783.88	21994.63	-9609.90	0.8995
B5		109%	250.73	29.73	19985.58	22368.91	-10046.88	0.8935
c1	max. over-excited	90%	207.12	31.92	17965.86	19855.14	8453.06	0.9048
c3		100%	230.14	31.72	19865.32	21944.89	9324.49	0.9052
c4		105%	241.03	27.39	19842.04	21894.52	9255.36	0.9063
P <sub>E<sub>max</sub>600</sub> [W]			20068.16					
S <sub>E<sub>max</sub>600</sub> [VA]			22368.91					
Model: SOFAR 25000TL-G2								
No.	Test condition		Measurement					
	CoS $\phi$	U / Un	U [V]	I [A]	P <sub>E<sub>max</sub>600 *</sub> [W]	S <sub>E<sub>max</sub>600 *</sub> [VA]	Q [Var]	CoS $\phi$
a1	1.00	90%	207.14	40.83	25371.13	25383.24	783.99	0.9995
a3		100%	229.99	36.92	25464.63	25473.06	655.25	0.9997
a5		109%	250.57	33.98	25532.29	25538.20	549.48	0.9998
b1	max. under-excited	95%	218.45	42.83	25270.47	28104.20	-12298.25	0.8992
b3		100%	229.79	40.87	25369.70	28213.64	-12344.42	0.8992
B5		109%	250.39	37.63	25449.81	28302.61	-12383.14	0.8992
c1	max. over-excited	90%	206.74	45.22	25295.97	28127.81	12299.76	0.8993
c3		100%	229.88	40.84	25400.52	28234.13	12327.71	0.8996
c4		105%	241.75	38.96	25479.80	28310.09	12338.39	0.9000
P <sub>E<sub>max</sub>600</sub> [W]			25532.29					
S <sub>E<sub>max</sub>600</sub> [VA]			28310.09					
Model: SOFAR 30000TL-G2								
No.	Test condition		Measurement					
	CoS $\phi$	U / Un	U [V]	I [A]	P <sub>E<sub>max</sub>600 *</sub> [W]	S <sub>E<sub>max</sub>600 *</sub> [VA]	Q [Var]	CoS $\phi$

a1	1.00	90%	206.87	48.24	29962.15	29983.22	1113.22	0.9993
a3		100%	230.00	43.95	30350.37	30362.65	833.92	0.9996
a5		109%	251.04	40.38	30442.27	30450.01	615.31	0.9997
b1	max. under-excited	95%	218.48	45.69	27167.09	29979.31	-12676.90	0.9062
b3		100%	229.96	47.88	29945.35	33071.60	-14035.74	0.9055
B5		109%	250.50	44.20	29989.33	33256.82	-14375.36	0.9018
c1	max. over-excited	90%	206.87	48.16	26894.26	29966.62	13217.14	0.8975
c3		100%	229.90	48.07	29823.25	33239.62	14677.91	0.8972
c4		105%	250.71	44.03	29776.87	33190.87	14661.72	0.8971
P <sub>E<sub>max600</sub></sub> [W]			30442.27					
S <sub>E<sub>max600</sub></sub> [V.A]			33256.82					
Model: SOFAR 33000TL-G2								
No.	Test condition		Measurement					
	CoS <sub>φ</sub>	U / U <sub>n</sub>	U [V]	I [A]	P <sub>E<sub>max600</sub> *)</sub> [W]	S <sub>E<sub>max600</sub> *)</sub> [VA]	Q [Var]	CoS <sub>φ</sub>
a1	1.00	90%	207.14	53.04	32911.77	32922.68	-847.20	0.9997
a3		100%	229.92	47.96	33038.70	33044.90	-640.25	0.9998
a5		109%	250.45	44.10	33083.61	33089.69	-633.98	0.9998
b1	max. under-excited	95%	218.14	50.75	29648.37	33174.73	-14884.07	0.8937
b3		100%	230.34	53.11	32911.86	36678.03	-16188.80	0.8973
B5		109%	250.63	48.96	32968.39	36782.58	-16310.76	0.8963
c1	max. over-excited	90%	207.12	53.03	29735.06	32966.41	14234.02	0.9020
c3		100%	230.15	52.60	32742.16	36328.25	15738.11	0.9013
c4		105%	241.65	50.00	32696.44	36268.04	15694.10	0.9015
P <sub>E<sub>max600</sub></sub> [W]			33083.61					
S <sub>E<sub>max600</sub></sub> [VA]			36782.58					

5.4.3 Active power reduction through setpoint specification				P
Measurement Item	Power Setting [W]	Actual Power [W]	Tolerance of power [W]	$\Delta P / P_n$ [%]
100%	33000	33062.58	62.58	0.1896
90%	29700	29834.79	134.79	0.4085
80%	26400	26518.18	118.18	0.3581
70%	23100	23196.60	96.60	0.2927
60%	19800	19810.36	10.36	0.0314
50%	16500	16490.40	-9.60	-0.0291
40%	13200	13209.03	9.03	0.0274
30%	9900	9925.49	25.49	0.0772
20%	6600	6607.74	7.74	0.0235
10%	3300	3291.33	-8.67	-0.0263
Limitation of $\Delta P / P_n$		± 5%		

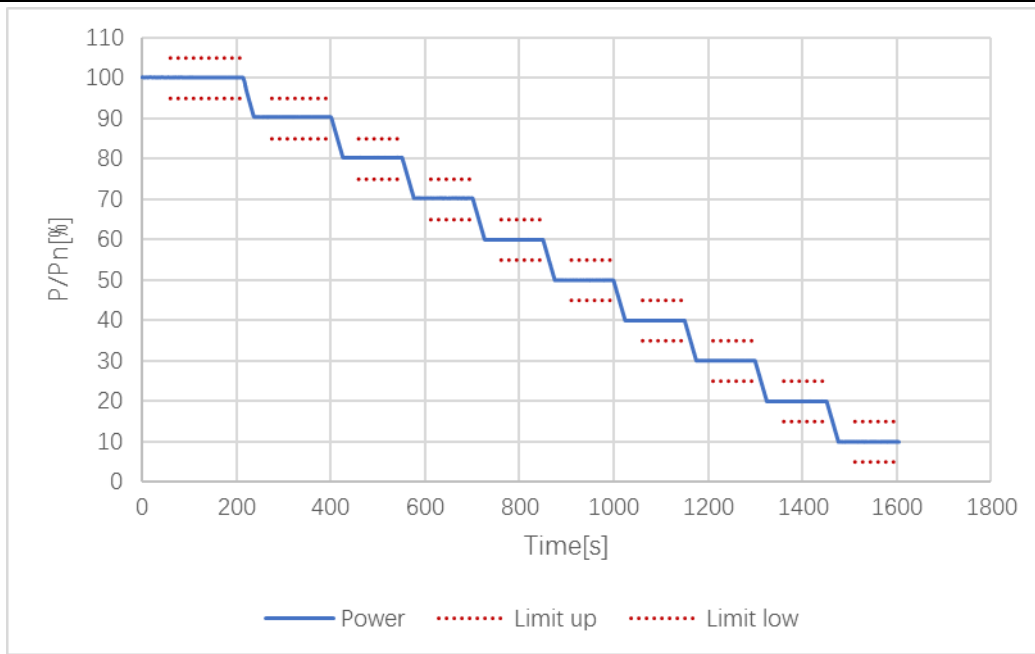

Power gradient (100%Pn ->5%Pn) [W/s]:	138.36W/s
Power gradient (5%Pn ->100%Pn) [W/s]:	136.79W/s
Limitation of gradient [W/s]	0.33%Pn – 0.66%Pn

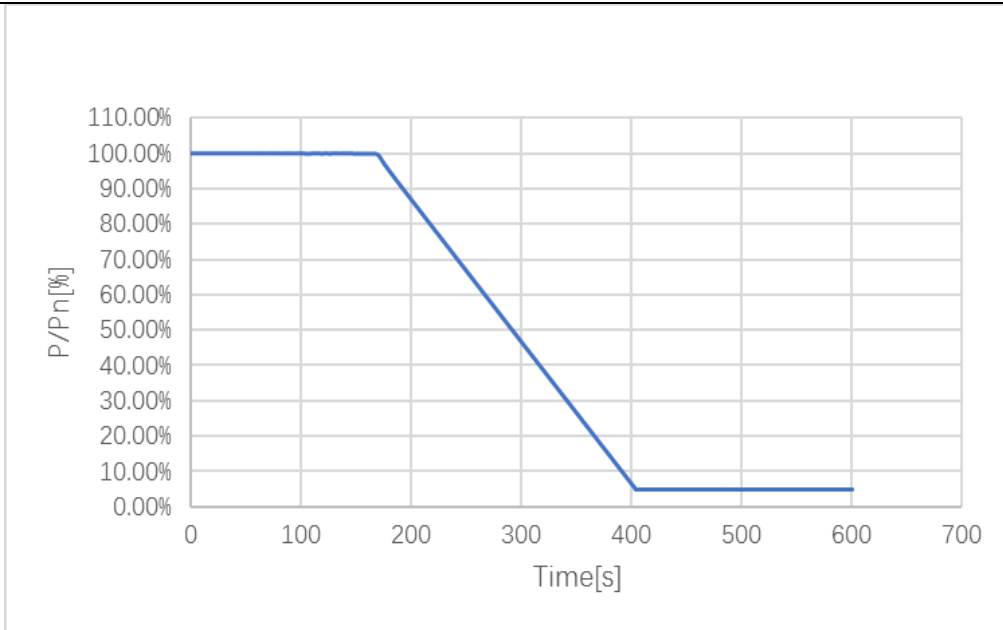

Power gradient from 100% to 5%

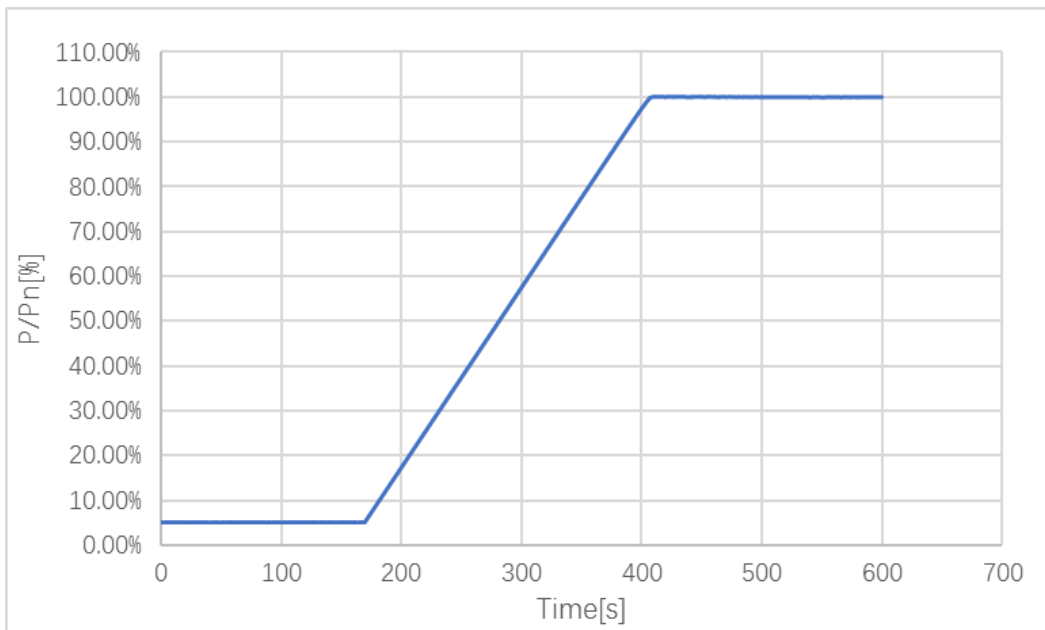

Power gradient from 5% to 100%

**The exact name of interface:** Logic interface

**Information:** if receiving the signal is low, the interface will change the state of power, which specified in the manual

**Response time of Activation of interface:** Response time (5s limitation): Primary power:100% to 0%

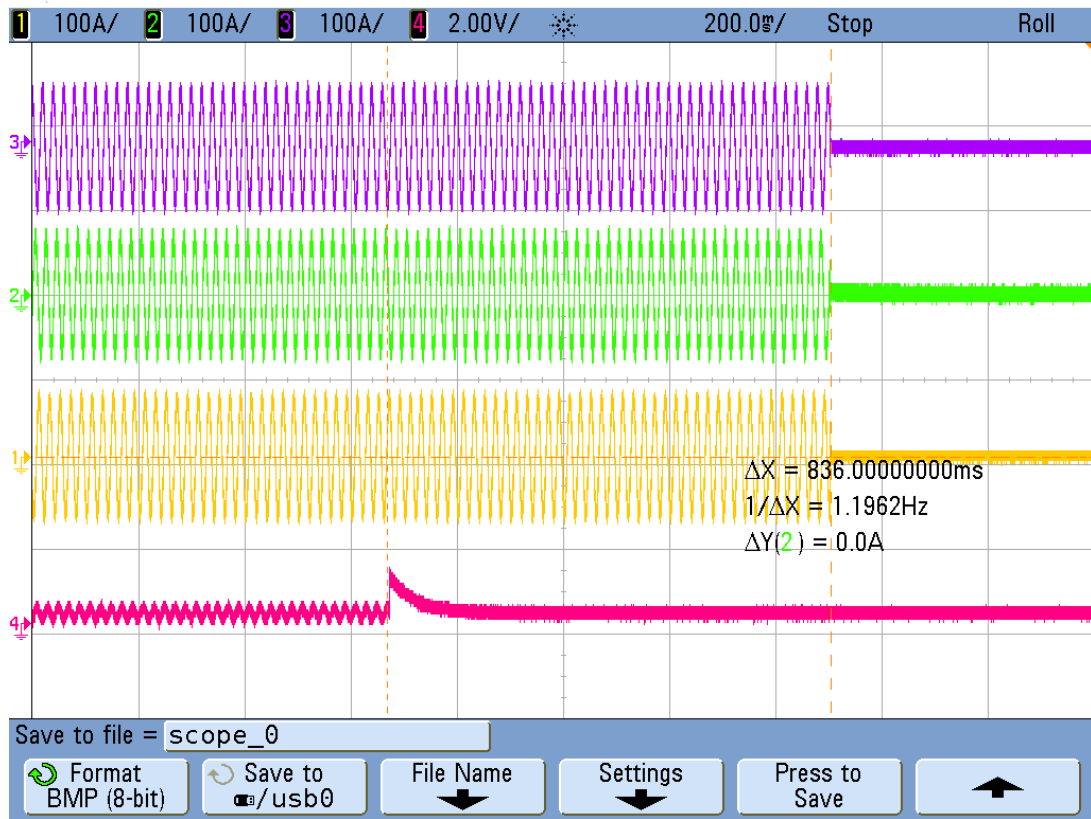

Response time: 0.836s

Noted: CH4 represents signal for activating logic interface, CH3: Current of EUT, CH2: Voltage of EUT

5.4.3.5 Measurement priority interfaces / energy management system

Interface	1	2	3	4
test 1: P in pu soll	0.6	1.0	0.3	0
test 2: P in pu soll	0.3	1.0	0	0.6
test 3: P in pu soll	1.0	0	0.6	0.3

The PGU is always response at the lowest priority.

5.4.4	Active power supply at overfrequency							P	
Test 1 Setting parameters of the EZE: P = 100% PEmax Start of power reduction at 50.2 Hz s = 5% (40% Pref / Hz)	40%PEmax (W)		13200			10%PEmax (W)		3300	
	f (Hz)	Expected Active power output [P/ PEmax] [%]	Measured output Power (W)	Tolerance between measured P and Expected [ $\Delta$ P/ PEmax] [%]	Tolerance Limit [%]	Time			
						The initial time delay TV <2s	The response times $T_{an\_90\%}$ <2s	The settling times <20s	
a) 50Hz $\pm$ 0.01Hz	50.00	100	33015.66	0.05	< $\pm$ 5%	--	--	--	
b) 50.25Hz $\pm$ 0.01Hz	50.25	98	32387.61	0.14	< $\pm$ 10%	0.2s	0.2	0.2	
c) 50.70Hz $\pm$ 0.01Hz	50.70	80	26454.29	0.16	< $\pm$ 10%	--	0.4	8.8	
d) 51.40Hz $\pm$ 0.01Hz	51.40	52	17300.39	0.43	< $\pm$ 10%	--	0.4	8.6	
e) 50.70Hz $\pm$ 0.01Hz	50.70	80	26465.28	0.20	< $\pm$ 10%	--	0.4	3.0	
f) 50.25Hz $\pm$ 0.01Hz	50.25	98	32397.64	0.17	< $\pm$ 10%	--	0.6	3.2	
g) 50Hz $\pm$ 0.01Hz	50.00	100	32960.14	-0.12	< $\pm$ 10%	--	0.8	1.0	
h) 51.65Hz $\pm$ 0.01Hz	Disconnection Time[ms]:100, Limitation[ms]: 200								
i) 50.15Hz $\pm$ 0.01Hz	Reconnection: <input type="checkbox"/> Yes/ <input checked="" type="checkbox"/> No, Limitation: No reconnection is allowed.								
j) 50.00Hz $\pm$ 0.01Hz	Reconnection time: 69s Maximal Rising Gradient [%/min]:8.95%, Limitation [%/min]: 10%								

Test 2 Setting parameters of the EZE: P = 60% P <sub>E</sub> max (The reduction of the primary energy supply to limit the active power output, or the limiting setting of the active power output must be removed from measuring point c) Start of power reduction at 50.5 Hz s= 12% (16.67% P / Hz)	16.67%P <sub>E</sub> max (W)		5501.10		10%P <sub>E</sub> max (W)		3300	
	f (Hz)	Expected Active power output [P/ P <sub>E</sub> max] [%]	Measured output Power (W)	Tolerance between measured P and Expected [ΔP/ P <sub>E</sub> max] [%]	Tolerance Limit [%]	Time		
						The initial time delay TV <2s	The response times T <sub>an_90</sub> % <2s	The settling times <20s
a)50Hz ± 0.01Hz	50.00	60	19865.88	0.20	< ± 5%	--	--	--
b)50.40Hz ± 0.01Hz	50,40	60	19867.08	0.20	< ± 10%	--	--	--
c)50.70Hz ± 0.01Hz	50.70	58	19212.66	0.22	< ± 10%	0.2	0.4	0.4
d)51.40Hz ± 0.01Hz	51.40	51	16848.41	0.06	< ± 10%	--	0.6	6.0
e)50.70Hz ± 0.01Hz	50.70	58	19212.83	0.22	< ± 10%	--	1.6	4.2
f)50.10Hz ± 0.01Hz	50.10	60-100	Maximal Rising Gradient [%/min]: 8.95, Limitation [%/min]: 10%					
g)50Hz ± 0.01Hz	50.00	100	--					



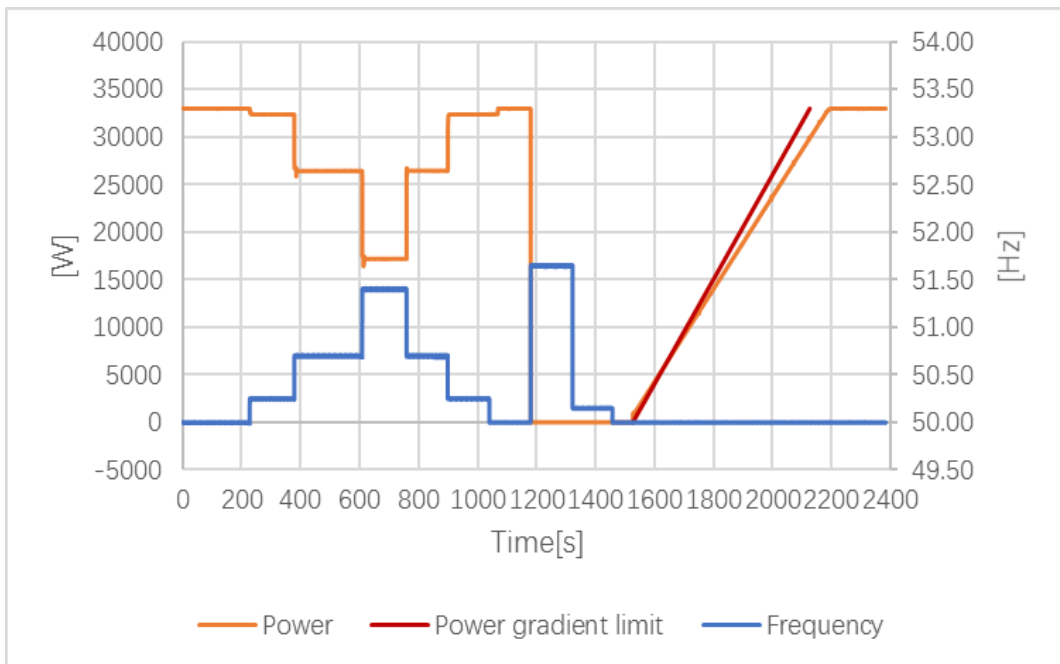

Test 1 P&F curve

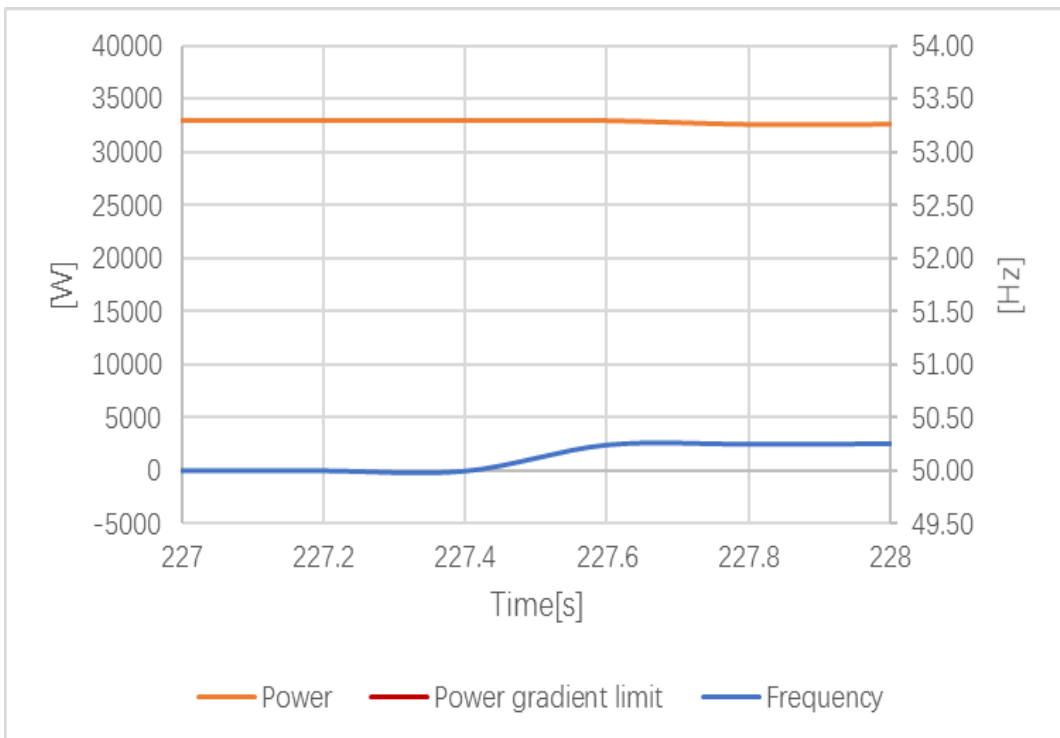

Response time

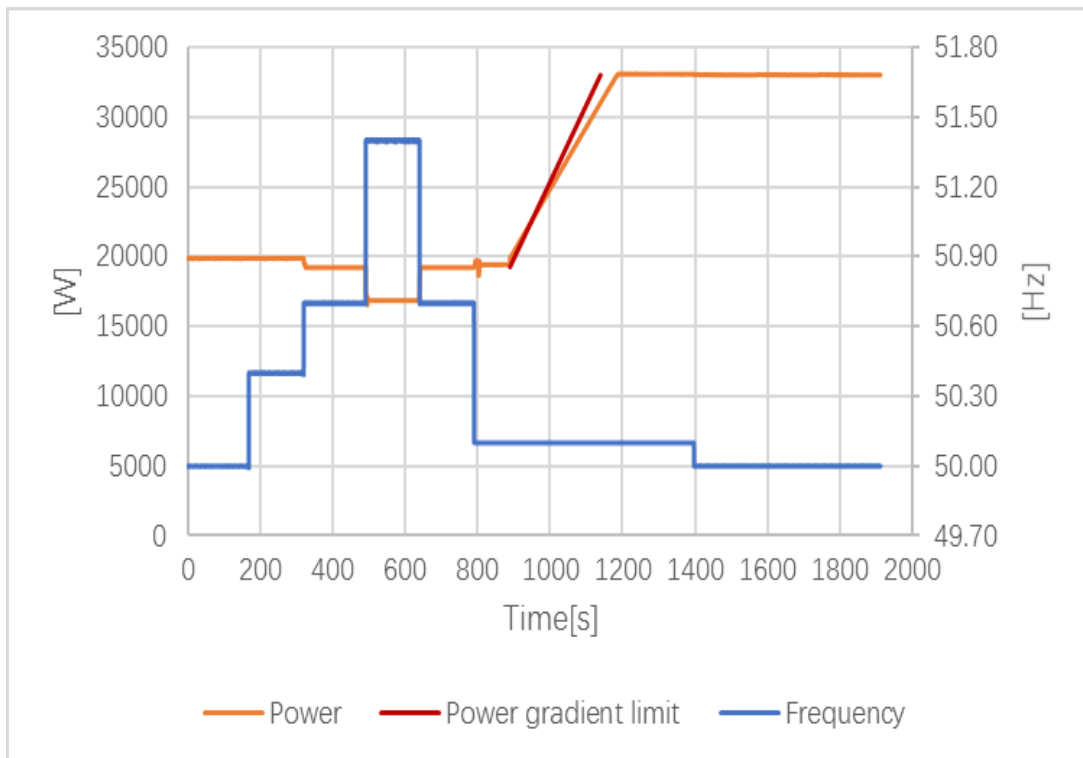

Test 2 P&F curve

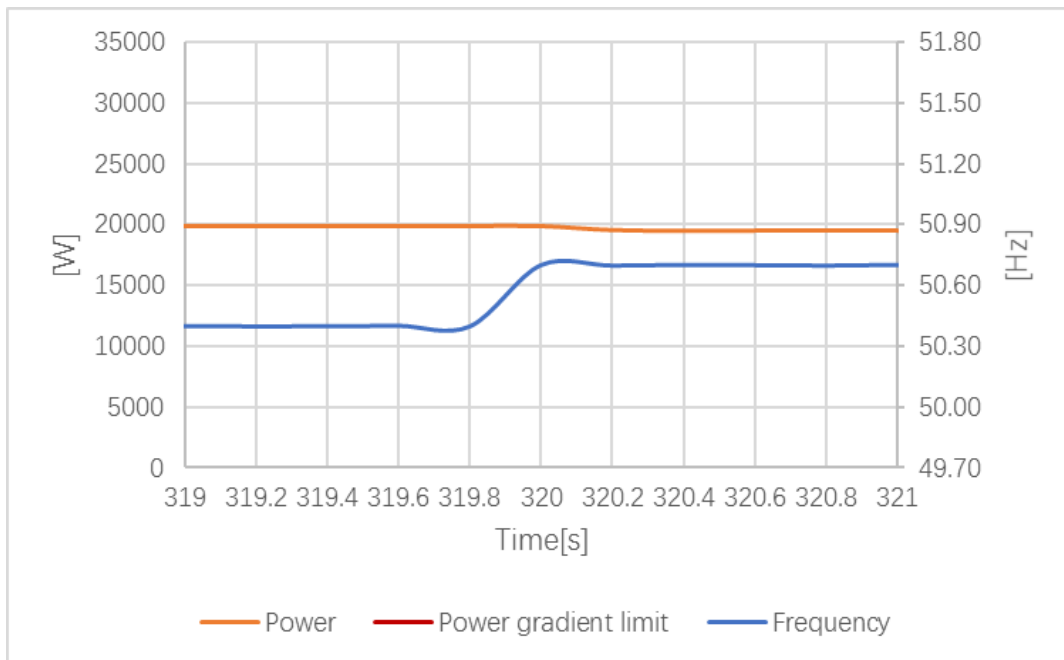

Response time

5.4.6	Active power supply at underfrequency							P	
Test 1  Setting parameters of the EZE:P=10%  Start of power reduction at 49.8 Hz	40%P <sub>E<sub>max</sub></sub> (W)		13200			10%P <sub>E<sub>max</sub></sub> (W)		3300	
	f (Hz)	Expected Active power output [P/P <sub>E<sub>max</sub></sub> ] [%]	Measured output Power (W)	Tolerance between measured P and Expected [ $\Delta$ P/P <sub>E<sub>max</sub></sub> ] [%]	Tolerance Limit [%]	Time			
						The initial time delay TV <2s	The response times T <sub>an_90</sub> % <2s	The settling times <20s	
a) 50Hz ± 0.01Hz	50.00	10	3328.20	0.09	< ± 5%	--	--	--	
b)49.75Hz ± 0.01Hz	49.75	12	3993.72	0.10	< ± 10%	0.2	0.8	1.0	
c)48.80Hz ± 0.01Hz	48.80	50	16607.06	0.32	< ± 10%	--	0.8	0.8	
d)47.60Hz ± 0.01Hz	47.60	98	32352.91	0.04	< ± 10%	--	0.2	0.4	
e)48.80Hz ± 0.01Hz	48.80	50	16608.08	0.33	< ± 10%	--	1.8	2.0	
f)49.85Hz ± 0.01Hz	49.85	12	4017.86	0.18	< ± 10%	--	0.6	0.8	
g)50Hz ± 0.01Hz	50.00	10	3328.50	0.09	< ± 10%	--	--	--	
h)47.35Hz± 0.01Hz	Disconnection Time[ms]: 100, Limitation[ms]: _200_								
i)47.60Hz± 0.01Hz	Reconnection: <input type="checkbox"/> Yes/ <input checked="" type="checkbox"/> No, Limitation: No reconnection is allowed.								
j)50.00Hz± 0.01Hz	Reconnection time: 69.0s Maximal Rising Gradient [%/min]: _8.98%, Limitation [%/min]: 10%								

Test 2 Setting parameters of the EZE: P = 60% P <sub>Emax</sub> (The reduction of the primary energy supply to limit the active power output, or the limiting setting of the active power output must be removed from measuring point c) Start of power reduction at 49.8 Hz	40%P <sub>Emax</sub> (W)		13200		10%P <sub>Emax</sub> (W)	3300		
	f (Hz)	Expected Active power output [P/ P <sub>Emax</sub> ] [%]	Measured output Power (W)	Tolerance between measured P and Expected [ΔP/ P <sub>Emax</sub> ] [%]	Tolerance Limit [%]	Time		
						The initial time delay TV <2s	The response times T <sub>an_90 %</sub> <2s	The settling times <20s
a)50Hz ± 0.01Hz	50.00	60	19817.54	0.05	< ± 5%	--	--	--
b)49.75Hz ± 0.01Hz	49.75	62	20570.90	0.34	< ± 10%	0.2	0.8	7.6
c)49.20Hz ± 0.01Hz	49.20	84	27780.67	0.18	< ± 10%	--	0.8	0.8
d)48.80Hz ± 0.01Hz	48.80	100	32978.88	-0.06	< ± 10%	--	0.8	0.8
e)49.20Hz ± 0.01Hz	49.20	84	27759.74	0.12	< ± 10%	--	0.8	0.8
f)49.85Hz ± 0.01Hz	49.85	60	19831.34	0.09	< ± 10%	--	0.8	0.8
g)50Hz ± 0.01Hz	50.00	60	19840.45	0.12	< ± 10%	---	--	--

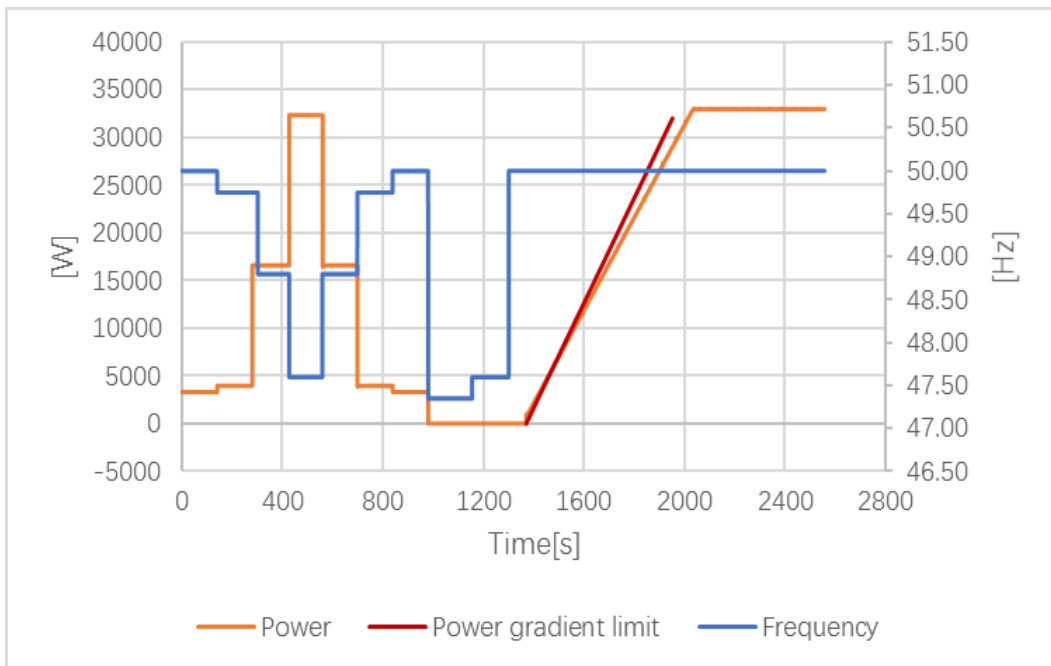

Test 1 P&F curve

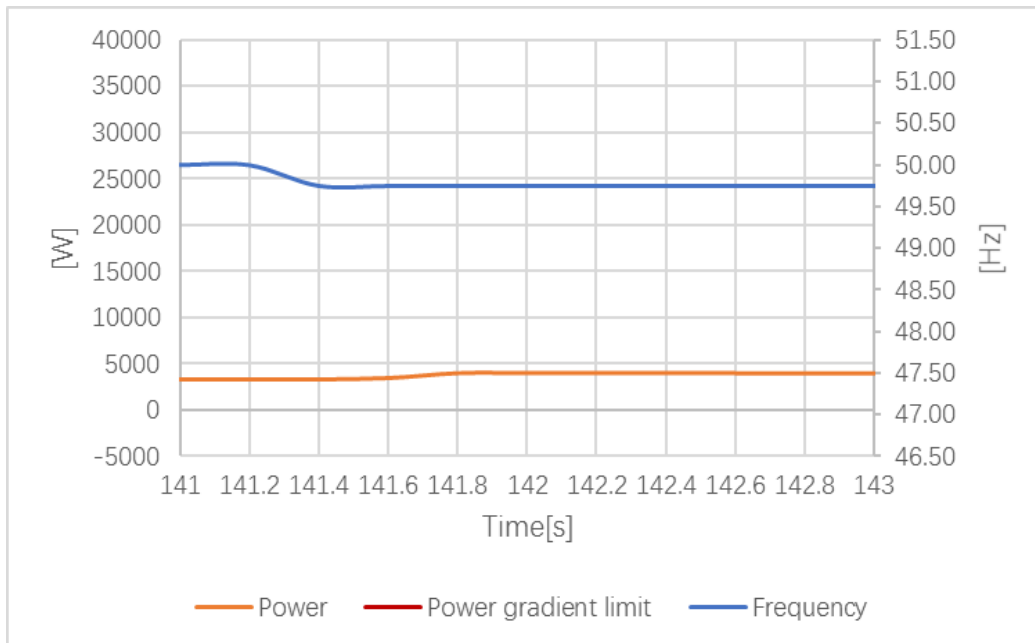

Response time

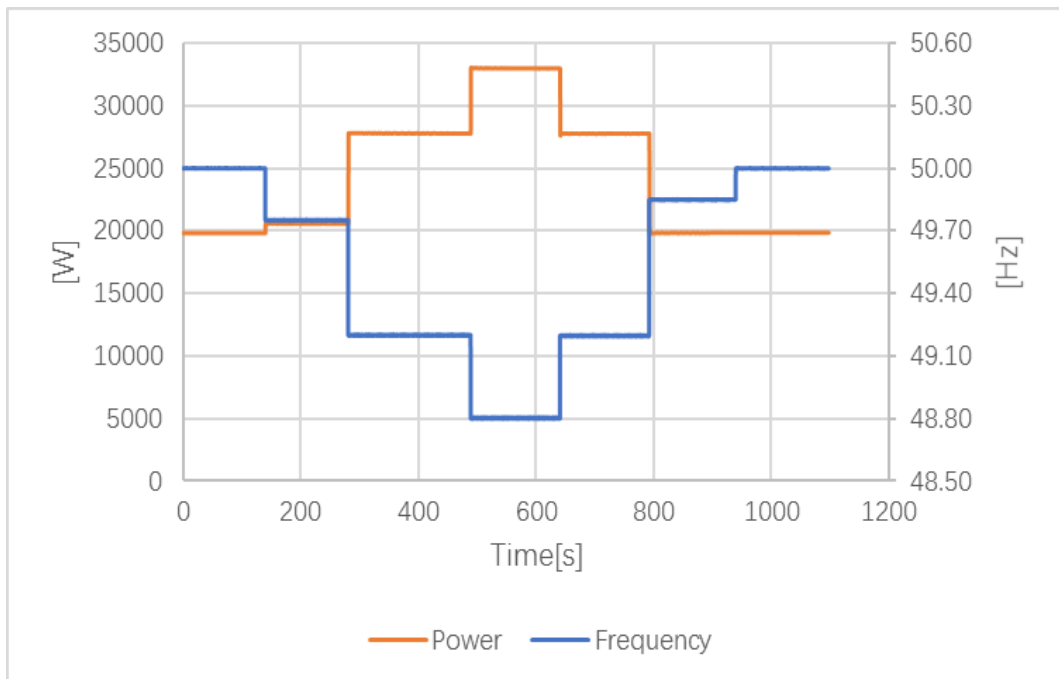

Test 2 P&F curve

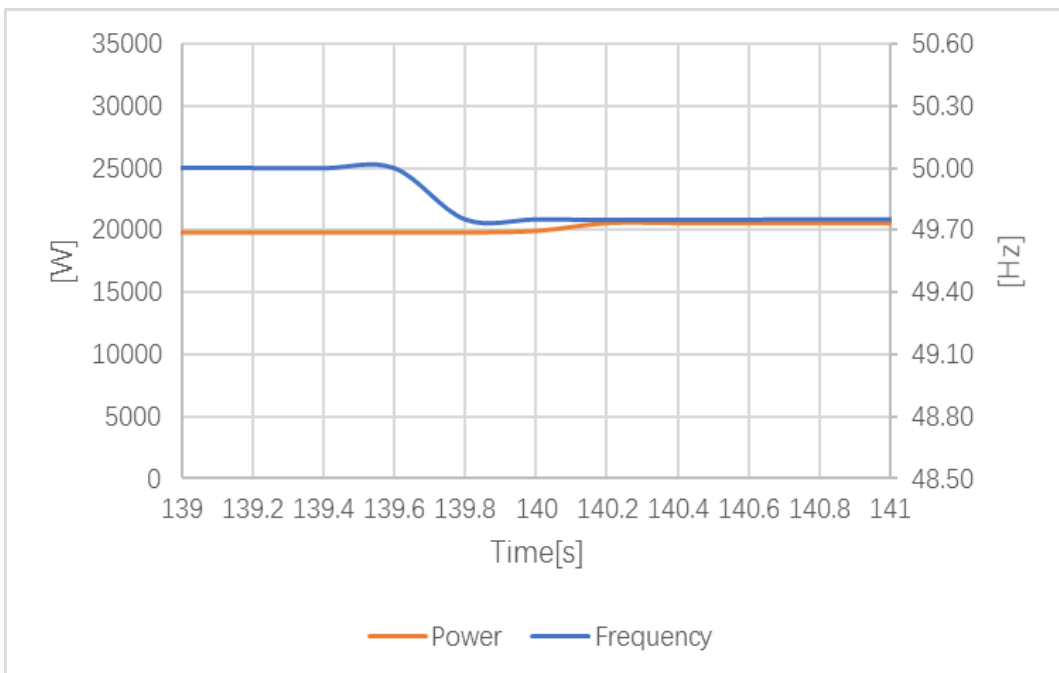

Response time

5.4.8.2		TABLE: Reactive power / displacement factor setting accuracy							P	
	Cosφ	Power	U [V]	P [W]	S [VA]	Q [Var]	cos φ	Δ Q / P <sub>E<sub>max</sub></sub>	Limit Δ Q / P <sub>E<sub>max</sub></sub>	
<input checked="" type="checkbox"/> Σ S <sub>E<sub>max</sub></sub> > 4.6kVA										
c)	0.90 under- excited	50%P <sub>E<sub>max</sub></sub>	207.25	16610.38	16616.86	-388.00	0.9996	Pass for voltage-reactive restriction		
			229.74	16601.79	18344.94	-7804.90	0.9050	0.5649	≤ ±4%	
			252.98	16644.90	18415.88	-7879.79	0.9038	0.3380	≤ ±4%	
		S <sub>E<sub>max</sub></sub>	207.58	32958.53	32984.92	-165.62	0.9992	Pass for voltage-reactive restriction		
			229.97	32961.00	36717.10	-16177.60	0.8977	-0.5908	≤ ±4%	
			252.83	33071.09	36842.55	-16237.98	0.8976	-0.7738	≤ ±4%	
	0.95 under- excited	50%P <sub>E<sub>max</sub></sub>	207.22	16608.83	16615.32	-389.68	0.9996	Pass for voltage-reactive restriction		
			230.05	16632.30	17591.02	-5727.96	0.9455	-0.9232	≤ ±4%	
			253.00	16674.67	17655.02	-5801.23	0.9445	-1.1453	≤ ±4%	
		S <sub>E<sub>max</sub></sub>	207.46	32958.81	32985.36	-110.60	0.9992	Pass for voltage-reactive restriction		
			229.98	33037.14	34849.77	-11092.75	0.9480	-0.7460	≤ ±4%	
			252.85	33155.44	34976.13	-11137.45	0.9479	-0.8814	≤ ±4%	
d)	0.90 over- excited	50%P <sub>E<sub>max</sub></sub>	207.06	16564.51	18337.10	7865.43	0.9033	-0.3815	≤ ±4%	
			229.95	16630.21	18382.61	7832.95	0.9047	-0.4799	≤ ±4%	
			252.76	16699.94	16706.22	-457.62	0.9996	Pass for voltage-reactive restriction		
		S <sub>E<sub>max</sub></sub>	206.83	29947.10	33255.73	15460.65	0.9005	-1.5818	≤ ±4%	
			230.34	32953.37	36593.03	15909.74	0.9005	-0.2209	≤ ±4%	
			252.99	33210.63	33219.98	-399.30	0.9997	Pass for voltage-reactive restriction		
	0.95 over- excited	50% P <sub>E<sub>max</sub></sub>	207.02	16595.29	17418.88	5292.71	0.9527	-0.3957	≤ ±4%	
			229.92	16646.92	17453.52	5244.44	0.9538	-0.5420	≤ ±4%	
			253.04	16699.57	16705.88	-458.08	0.9996	Pass for voltage-reactive restriction		
		S <sub>E<sub>max</sub></sub>	206.88	31623.12	33284.83	10385.25	0.9501	-1.3980	≤ ±4%	
			230.07	33052.95	34768.07	10784.94	0.9507	-0.1868	≤ ±4%	
			253.00	33207.80	33217.18	-420.00	0.9997	Pass for voltage-reactive restriction		

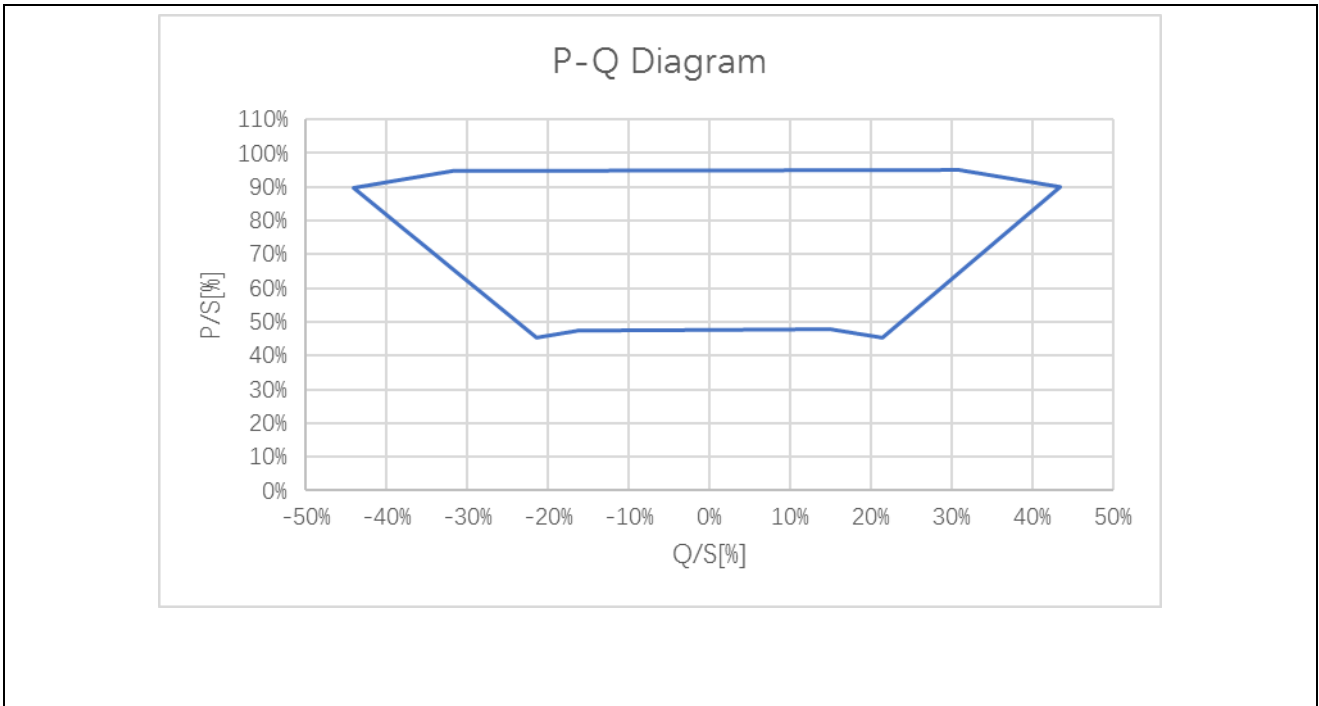



Step	Pdc[W]	P[W]	Q[Var]	Cosφ	Qdesired	$\Delta Q / P_{E_{max}}$ [%]	Limitation
100%	33998.99	32928.11	-15981.10	0.8996	-15982.63	0.0046	± 4%
90%	30619.828	29702.14	-12782.33	0.9186	-12652.15	-0.3945	± 4%
80%	27239.05	26464.25	-9789.44	0.9379	-9581.92	-0.6288	± 4%
70%	23853.23	23207.88	-7041.44	0.9569	-6737.50	-0.9210	± 4%
60%	20460.71	19932.29	-4406.58	0.9764	-4020.56	-1.1698	± 4%
50%	17070.18	16651.52	-853.84	0.9987	0	-2.5874	± 4%
40%	13567.50	13242.79	-385.66	0.9996	0	-1.1687	± 4%
30%	10165.51	9920.11	-368.52	0.9993	0	-1.1167	± 4%
20%	6759.95	6586.30	-353.11	0.9986	0	-1.0700	± 4%
30%	10164.31	9922.39	-369.48	0.9993	0	-1.1196	± 4%
40%	13563.06	13246.31	-385.98	0.9996	0	-1.1696	± 4%
50%	16961.17	16562.74	-420.91	0.9997	0	-1.2755	± 4%
60%	20460.68	19956.70	-4417.59	0.9764	-4020.56	-1.2031	± 4%
70%	23849.98	23233.90	-7057.30	0.9568	-6737.50	-0.9691	± 4%
80%	27234.98	26493.76	-9805.95	0.9378	-9581.92	-0.6789	± 4%
90%	30618.35	29727.79	-12795.94	0.9185	-12652.15	-0.4357	± 4%
100%	33995.82	32932.21	-15983.14	0.8996	-15982.63	-0.0015	± 4%

P(t), Q(t), Q<sub>set</sub>(t), Cosφ(t), tolerance(t) Diagram

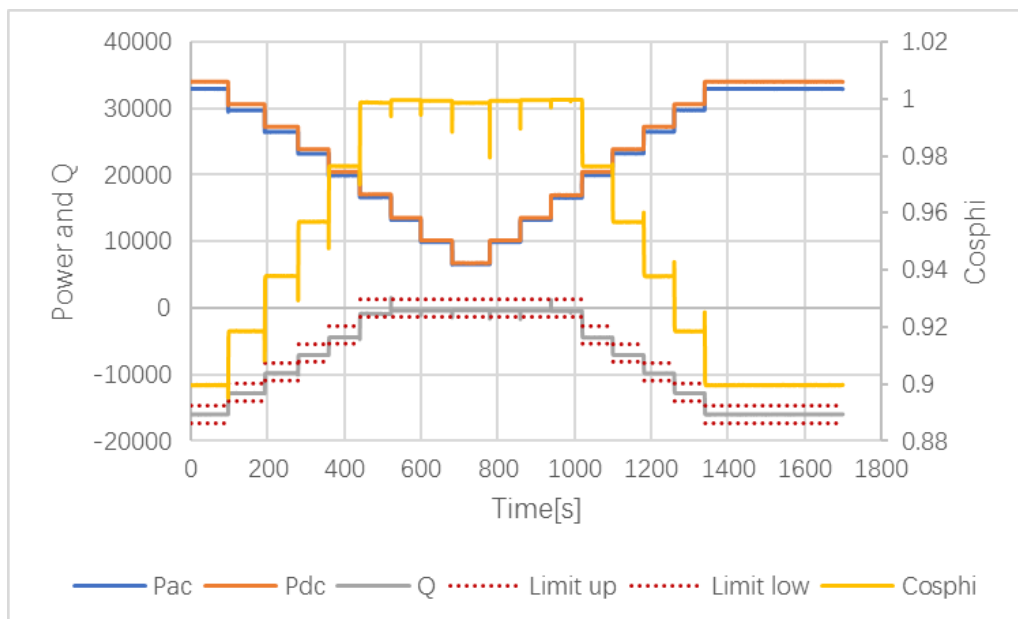

4) Test steps for supply-dependent EZE-dynamics		
P/ P <sub>n</sub> [%]	Duration [s]	Dynamic as PT1 character ?
100	60	--
40	60	<input checked="" type="checkbox"/> Pass <input type="checkbox"/> Failed
100	60	<input checked="" type="checkbox"/> Pass <input type="checkbox"/> Failed
75	60	<input checked="" type="checkbox"/> Pass <input type="checkbox"/> Failed

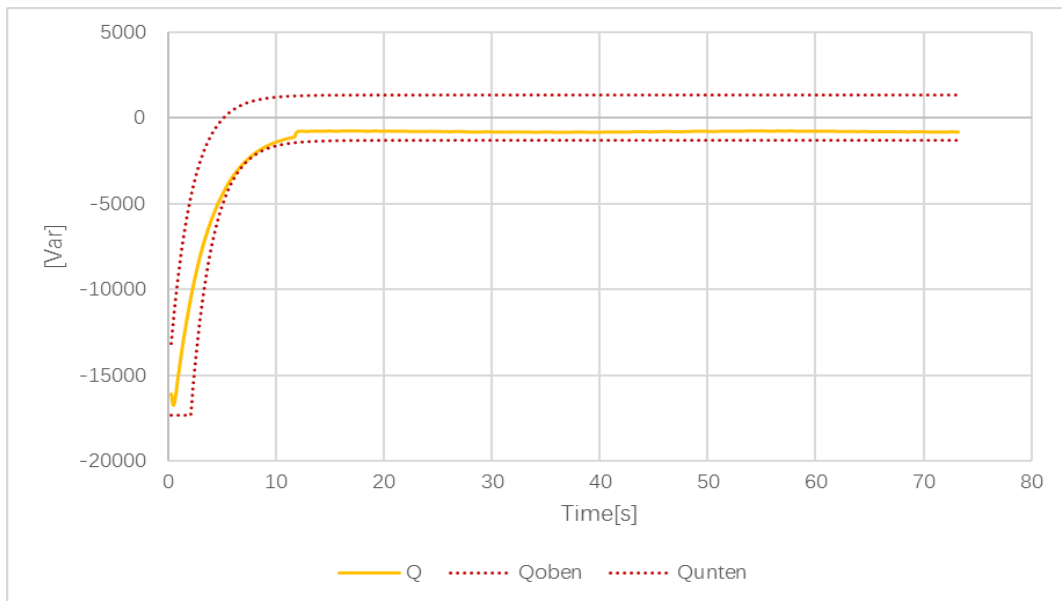

Power from 100% to 40% with PT1 character

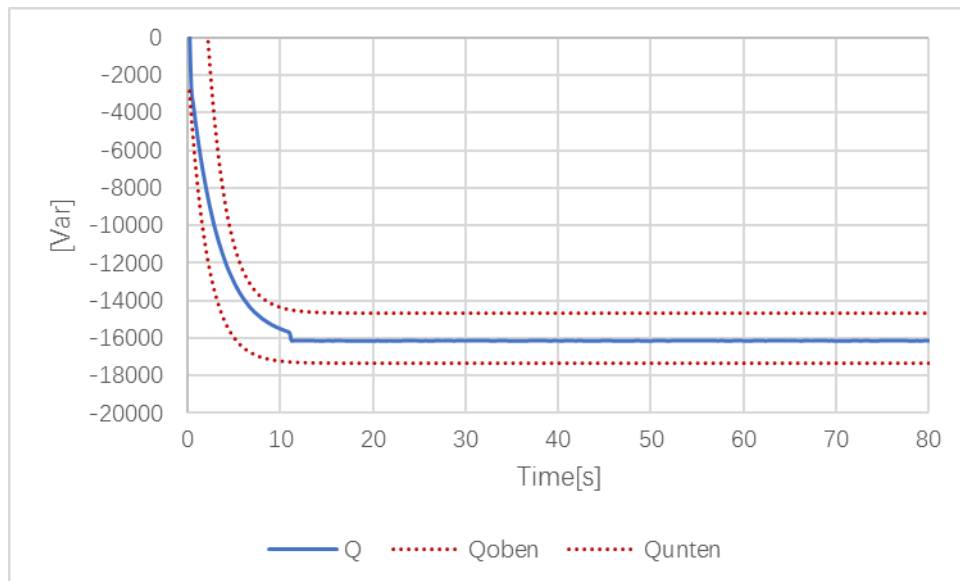

Power from 40% to 100% with PT1 character

5.4.8.4		TABLE: Checking the reactive power voltage characteristic Q(U)				P
5.4.8.4.1 Checking the accuracy of the Q (U) control						
Qmax=15981.9Var						
Voltage Setting U <sub>PGU</sub>	Target Q <sub>PGU</sub> [Var]	Measurement Q <sub>PGU</sub> [Var]	Measurement U <sub>PGU</sub> [V]	Δ Q <sub>PGU</sub> [Var]	Limitation Δ Q [Var]	
100%Un	0	1015.74	229.75	1015.74	±1320	
99%Un	0	1012.02	227.51	1012.02	±1320	
98%Un	0	1042.74	225.24	1042.74	±1320	
97%Un	0	1065.75	223.27	1065.75	±1320	
96%Un	3995.47	3547.35	220.73	-448.12	±1320	
95%Un	7990.95	7886.10	218.72	-104.85	±1320	
94%Un	11986.42	12410.83	216.48	424.41	±1320	
93%Un	15981.90	15145.30	213.92	-836.6	±1320	
92%Un	15981.90	16162.21	211.62	180.31	±1320	
91%Un	15981.90	16153.04	209.32	171.14	±1320	
90%Un	15981.90	16173.24	207.03	191.34	±1320	
91%Un	15981.90	16221.03	209.34	239.13	±1320	
92%Un	15981.90	16154.19	211.64	172.29	±1320	
93%Un	15981.90	15568.70	213.62	-413.2	±1320	
94%Un	11986.42	12993.53	216.09	1007.11	±1320	
95%Un	7990.95	7026.40	218.72	-964.55	±1320	
96%Un	3995.47	3296.47	220.75	-699	±1320	
97%Un	0	1083.74	223.30	1083.74	±1320	
98%Un	0	1039.86	225.30	1039.86	±1320	
99%Un	0	1050.07	227.57	1050.07	±1320	
100%Un	0	1023.77	229.85	1023.77	±1320	
101%Un	0	952.52	232.52	952.52	±1320	
102%Un	0	-952.12	234.80	-952.12	±1320	
103%Un	0	-1154.25	236.78	-1154.25	±1320	
104%Un	-3995.47	-3176.28	239.11	819.19	±1320	
105%Un	-7990.95	-8354.87	241.52	-363.92	±1320	
106%Un	-11986.42	-12069.05	243.96	-82.63	±1320	
107%Un	-15981.90	-15200.16	246.74	781.74	±1320	
108%Un	-15981.90	-16178.54	248.29	-196.64	±1320	
109%Un	-15981.90	-16166.86	250.51	-184.96	±1320	
110%Un	-15981.90	-16156.08	253.56	-174.18	±1320	
109%Un	-15981.90	-16166.24	250.57	-184.34	±1320	

108%Un	-15981.90	-16146.82	248.29	-164.92	±1320
107%Un	-15981.90	-15079.21	246.32	902.69	±1320
106%Un	-11986.42	-11699.56	244.07	286.86	±1320
105%Un	-7990.95	-8010.95	241.64	-20.00	±1320
104%Un	-3995.47	-3278.66	239.52	716.81	±1320
103%Un	0	-982.71	237.10	-982.71	±1320
102%Un	0	-960.57	234.79	-960.57	±1320
101%Un	0	-973.27	232.31	-973.27	±1320
100%Un	0	1003.43	230.62	1003.43	±1320

Q(U) Diagram

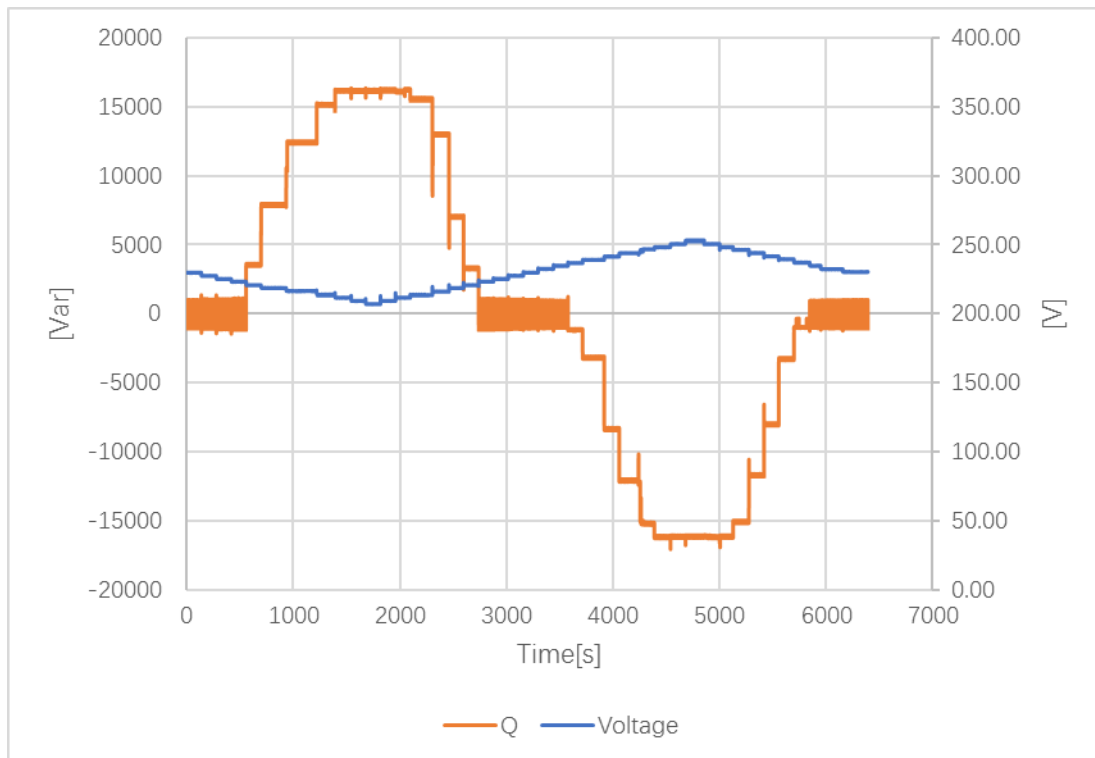

5.4.8.4.2 Checking the dynamics of the Q (U) control

X<sub>net</sub> value: 0.2547

K<sub>RR</sub> value: 4.9235

Voltage Setting U <sub>PGU</sub>	Target Q	Measurement Q <sub>SOIL</sub> [Var]	Measurement Q <sub>Start</sub> [Var]	Response time T <sub>MESS</sub> [s]	Parameterized response time T (s)	Dynamic as PT1
Reach to initial status, Q <sub>EZE</sub> = 0						
Un + ΔU <sub>ind,Y</sub>	Inductive, 0.95Q <sub>max</sub>	-16066.50	-1757.96	8.4	10	<input checked="" type="checkbox"/> Pass <input type="checkbox"/> Failed
Return to initial status, stationary operation for 1min, Q <sub>EZE</sub> = 0						
Un + ΔU <sub>ind,Y</sub>	Inductive,	-16094.70	-1840.31	8.6	10	<input checked="" type="checkbox"/> Pass

	0.95Qmax					<input type="checkbox"/> Failed
Return to initial status, stationary operation for 1min, Q <sub>EZE</sub> = 0						
Un + ΔU <sub>ind,Y</sub>	Inductive, 0.95Qmax	-16051.33	-2205.88	9.0	10	<input checked="" type="checkbox"/> Pass <input type="checkbox"/> Failed
Return to initial status, stationary operation for 1min, Q <sub>EZE</sub> = 0						
Un + ΔU <sub>Cap,Y</sub>	Capacitive, 0.95Qmax	16193.29	-1249.20	8.8	10	<input checked="" type="checkbox"/> Pass <input type="checkbox"/> Failed
Return to initial status, stationary operation for 1min, Q <sub>EZE</sub> = 0						
Un+ ΔU <sub>Cap,Y</sub>	Capacitive, 0.95Qmax	16196.39	-1221.43	8.6	10	<input checked="" type="checkbox"/> Pass <input type="checkbox"/> Failed
Return to initial status, stationary operation for 1min, Q <sub>EZE</sub> = 0						
Un + ΔU <sub>Cap,Y</sub>	Capacitive, 0.95Qmax	16201.30	-1249.83	8.8	10	<input checked="" type="checkbox"/> Pass <input type="checkbox"/> Failed

**Remark:**

$$X_{net} = 0.0218 \cdot 3 \cdot U_{NY}^2 / (0.85 \cdot |Q_{max}|)$$

$$\Delta U_{ind,Y} = 1.03 \cdot U_{NY} - U_{PGU} + (X_{net} / (3 \cdot U_{N,Y}) + 1 / k_{QU}) \cdot 0.85 \cdot |Q_{max}|$$

$$\Delta U_{Cap,Y} = 0.97 \cdot U_{NY} - U_{PGU} - (X_{net} / (3 \cdot U_{N,Y}) + 1 / k_{QU}) \cdot 0.85 \cdot |Q_{max}|$$

$$k_{QU} = |Q_{max}| / (0.04 \cdot U_{NY})$$

$$K_{RR} = 3 + |Q_{max}| \cdot X_{net} / 0.04 \cdot U_{NY}^2$$

Q(t), Q<sub>set</sub>(t), tolerance(t) Diagram

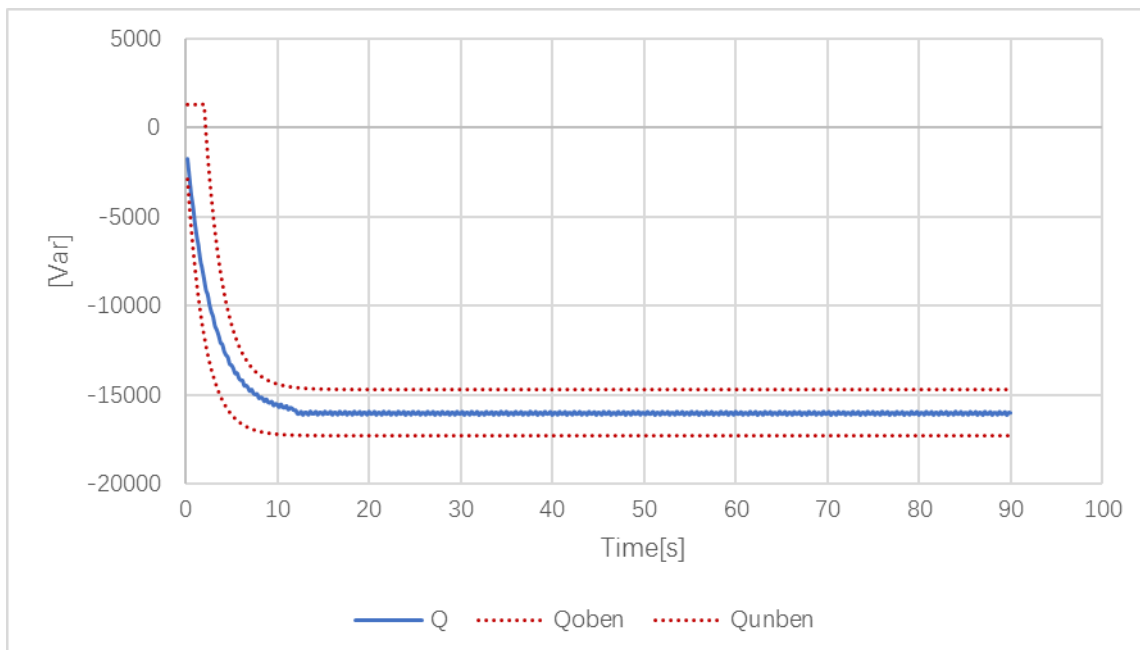

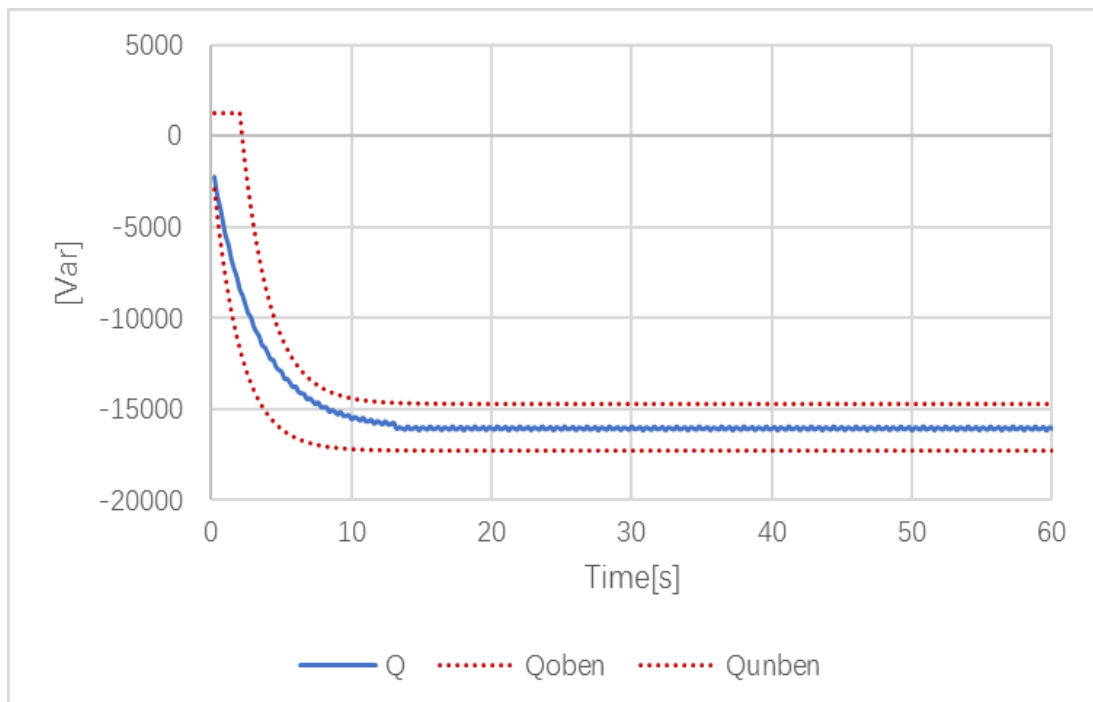
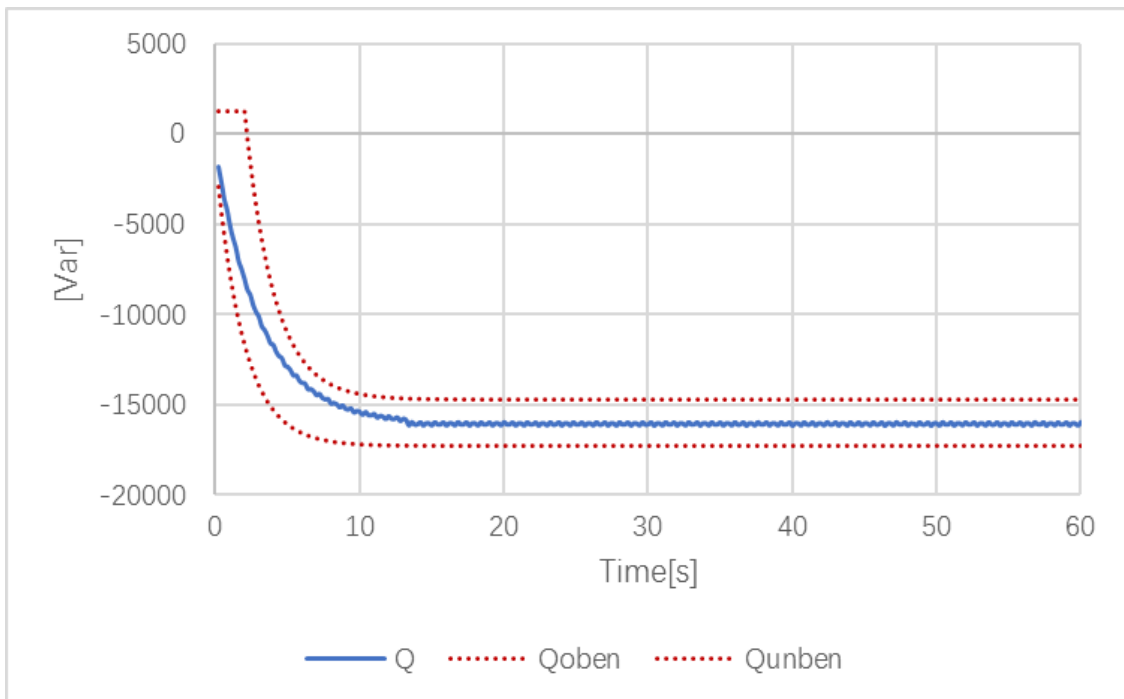

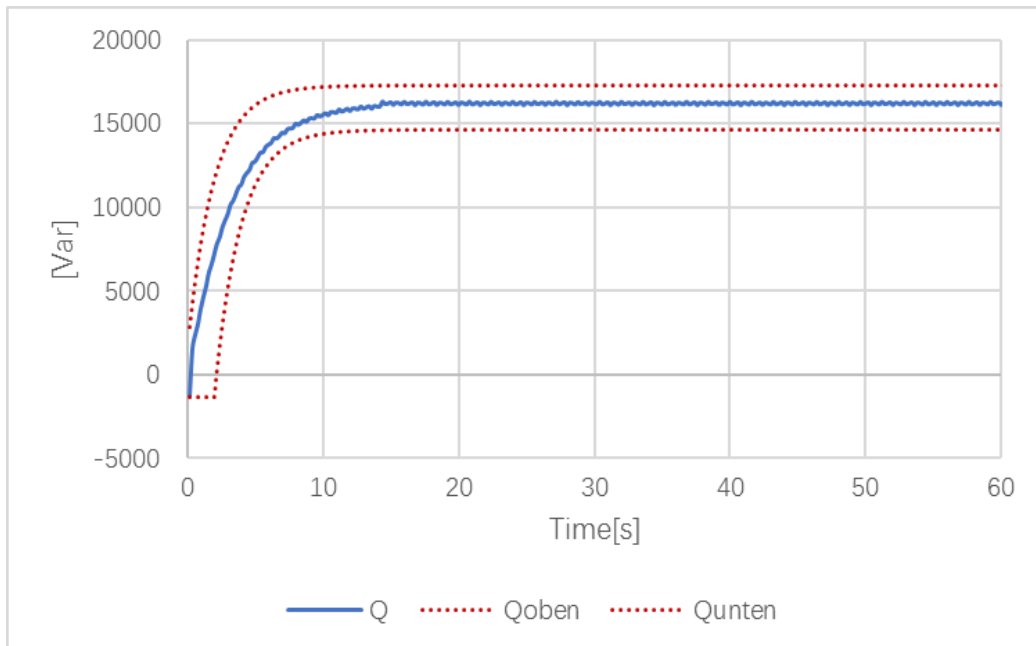
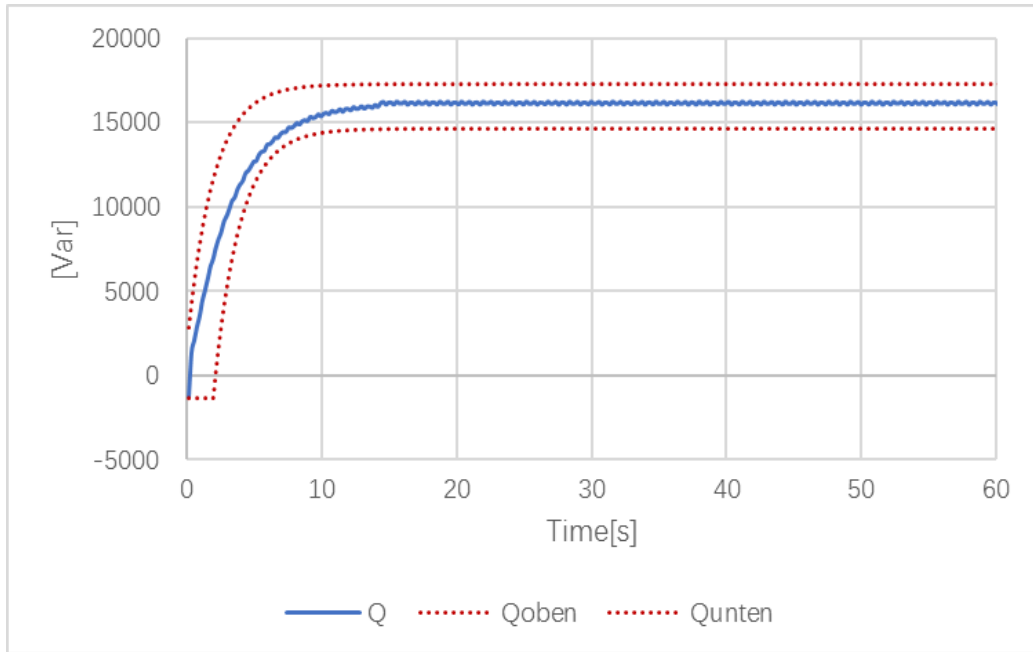

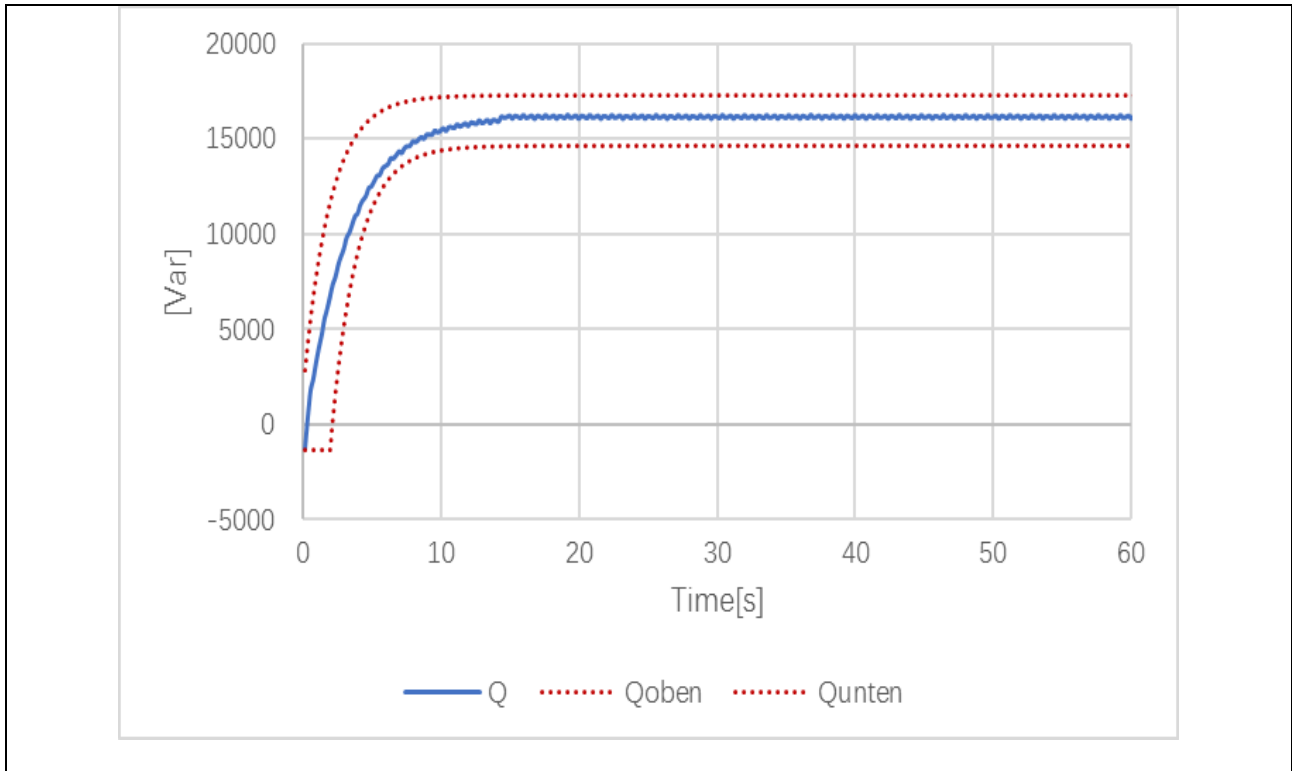



5.5.2, 5.5.3, 5.5.4	TABLE: Interface switch (Functional safety)						P
<input checked="" type="checkbox"/> Integrated interface switch							
<input checked="" type="checkbox"/> Complied with DIN EN 62109-2							
Switch manufacturer and type: ZETTLER electronics GmbH, type: T9VV1K15-12S							
Response time of interface switch for integrated NS protection: Max.20ms							
The max. initial short-circuited current of PGU Ik": 50A							
No.	component No.	fault	test voltage (V)	test time	fuse No.	fuse current (A)	result
1.	XLC2 Pin 2 to 3	Short	850	10 min	--	--	Inverter operated normally. No damaged.No hazards.
2.	RB 137	Open	850	10 min	--	--	Inverter disconnected from grid immediately. Error message:" The grid voltage error". No damaged.No hazards.
3.	RB 139	Short	850	10 min	--	--	Inverter disconnected from grid immediately. Error message:" The grid voltage error". No damaged.No hazards.
4.	RB 131	Open	850	10 min	--	--	Inverter disconnected from grid immediately. Error message:" The grid voltage error". No damaged.No hazards.
5.	RB 122	Open	850	10 min	--	--	Inverter disconnected from grid immediately. Error message:" The grid voltage error". No damaged.No hazards.
6.	RB 110	Short	850	10 min	--	--	Inverter disconnected from grid immediately. Error message:" The grid voltage error". No damaged.No hazards.
7.	RB 96	Short	850	10 min	--	--	Inverter disconnected from grid immediately. Error message:"GFCI error". No damaged.No hazard.
8.	RB 11	Open	850	10 min	--	--	Inverter disconnected from grid immediately. Error message:"GFCI error". No damaged.No hazard.

9.	RB 8	Short	850	10 min	--	--	Inverter disconnected from grid immediately. Error message:"GFCI error". No damaged.No hazard.
10.	UB1 PIN5 to 6	Short	850	10 min	--	--	Inverter disconnected from grid immediately. Error message:"GFCI error". No damaged.No hazard.
11.	RB 23	Short	850	10 min	--	--	Inverter disconnected from grid immediately. Error message:"GFCI error". No damaged.No hazard.
12.	QD1 PIN1 to 2	Short	850	10 min	--	--	Inverter disconnected from grid immediately. Error message:"The DCI overcurrent". No damaged.No hazard.
13.	XLC2 PIN1 to 2	Short	850	10 min	--	--	Inverter disconnected from grid immediately. Error message:"The communication error". No damaged.No hazard.
14.	DC 71	Short	850	10 min	--	--	Inverter disconnected from grid immediately. Error message:"The communication error". No damaged.No hazard.
15.	U13 PIN2 to 3	Short	850	10 min	--	--	Inverter disconnected from grid immediately. Error message:"The communication error". No damaged.No hazard.
16.	XLC1 PIN1 to 2	Short	850	10 min	--	--	Inverter did not start-up. Error message:"The SPI error" No damage.No hazard.
17.	RC6	Short	850	10 min	--	--	Inverter disconnected from grid immediately. Error message:" The grid voltage error". No damaged.No hazards.
18.	RC19	Short	850	10 min	--	--	Inverter disconnected from grid immediately. Error message:" The grid voltage error". No damaged.No hazards.
19.	UC627 PIN2 to 3	Short	850	10 min	--	--	Inverter disconnected from grid immediately. Error message:" The grid voltage error". No damaged.No hazards.

20.	UC637 PIN12 to 13	Short	850	10 min	--	--	Inverter disconnected from grid immediately. Error message:"GFCI error". No damaged.No hazard.
21.	RC 167	Short before start-up	850	10 min	--	--	Inverter did not start-up.Error message:"The ISO error" No damage.No hazard.
22.	RC 98	Short before start-up	850	10 min	--	--	Inverter did not start-up.Error message:"The ISO error" No damage.No hazard.
Supplement: s-c: short-circuited, o-c: open-circuited, o-l: overload							

5.5.7.3	TABLE: Wiring test	P
---------	--------------------	---

Checking Voltage and frequency as below

U L1-E	219,4 V	0°	50,00 Hz
U L2-E	230,9 V	-120°	50,00 Hz
U L3-E	242,5 V	120°	50,00 Hz

And then applying Voltage and frequency as below

U L1-E	0,0 V	0,00°	50,00 Hz
U L2-E	230,9 V	150,00°	50,00 Hz
U L3-E	230,9 V	-150,00°	50,00 Hz

The voltage read on the NA protection documents:



5.5.7.2 & 5.5.7.4		TABLE: Protection device and settings				P
OV Stage 2	Set value	Measured			Limitation	Test condition
No.		L1-N	L2-N	L3-N		
1	1.25Un	287.67V	287.72V	287.77V	+/-1%Un	1, applying ramp test, start of <282.9 V, and ramp to >292.1 V, step voltage length is <1.15 V, and step time is >400ms 2, applying Jump test, start of <282.9 V, and jump to >292.1 V, step voltage length is >9.2 V, and step time is >400ms
	100ms	69.0ms	93.0ms	91.5ms	≤200ms	
2	1.25Un	287.92V	287.83V	287.69V	+/-1%Un	
	100ms	76.5ms	74.0ms	75.5ms	≤200ms	
3	1.25Un	287.61V	287.61V	287.70V	+/-1%Un	
	100ms	64.0ms	79.0ms	82.0ms	≤200ms	
4	1.25Un	287.79V	287.85V	287.97V	+/-1%Un	
	100ms	62.0ms	76.5ms	71.0ms	≤200ms	
5	1.25Un	287.91V	287.89V	287.76V	+/-1%Un	
	100ms	92.0ms	62.0ms	72.0ms	≤200ms	

OV Stage 1	Set value	Trip time [s]	Limitation [s]	Test condition
No.				
1	1.10Un	530.0s	450-550	Operation under nominal voltage for 10min, then jumped from Un to 1.12Un.
2	100ms	No disconnect	No disconnect	Operation under nominal voltage for 10min, then jumped from Un to 1.08Un.
3		303.0s	225 - 375	Operation under 1.06 voltage for 10min, then jumped from 1.06Un to 1.14Un.

UV Stage 2	Set value	Measured			Limitation [ms]	Test condition
No.		L1-N	L2-N	L3-N		
1	0.45Un	103.14V	103.16V	103.17V	+/-1%Un	1, applying ramp test, start of >108.1 V, and ramp to <98.9V, step voltage length is <1.15 V, and step time is >500ms 2, applying Jump test, start of >108.1 V, and jump to <98.9V, step voltage length is >9.2 V, and step time is >500ms
	300ms	320ms	320ms	332ms	300-400ms	
2	0.45Un	103.16V	103.15V	103.15V	+/-1%Un	
	300ms	330ms	316ms	334ms	300-400ms	
3	0.45Un	103.17V	103.17V	103.15V	+/-1%Un	
	300ms	314ms	326ms	328ms	300-400ms	
4	0.45Un	103.14V	103.15V	103.15V	+/-1%Un	
	300ms	326ms	334ms	330ms	300-400ms	
5	0.45Un	103.16V	103.17V	103.15V	+/-1%Un	
	300ms	322ms	324ms	331ms	300-400ms	

UV Stage 1	Set value	Measured			Limitation [ms]	Test condition
No.		L1-N	L2-N	L3-N		
1	0.8Un	183.33V	183.30V	183.31V	+/-1%Un	1, applying ramp test, start of >188.6 V, and ramp to <179.4V, step voltage length is <1.15 V, and step time is >3.2s 2, applying Jump test, start of >200.1 V, and jump to <179.4V, step voltage length is >9.2 V, and step time is >3.2s
	3s	3.02s	3.05s	3.02s	3-3.1s	
2	0.8Un	183.30V	183.32V	183.32V	+/-1%Un	
	3s	3.02s	3.04s	3.04s	3-3.1s	
3	0.8Un	183.31V	183.31V	183.33V	+/-1%Un	
	3s	3.05s	3.02s	3.02s	3-3.1s	
4	0.8Un	183.32V	183.32V	183.31V	+/-1%Un	
	3s	3.03s	3.04s	3.03s	3-3.1s	
5	0.8Un	183.32V	183.25V	183.27V	+/-1%Un	
	3s	3.01s	3.04s	3.04s	3-3.1s	

OF	Set value	Measured					Limitation	Remark
No.		Trip value						
1	51.5Hz	51.51	51.51	51.51	51.51	51.51	+/-0.05Hz	1, applying ramp test, start of <51.4Hz, and ramp to >51.6Hz, step frequency length is <0.025 Hz, and step time is >400ms 2, applying Jump test, start of <51.4Hz, and jump to >51.6Hz, step frequency length is >0.2Hz, and step time is >400ms
2	100ms	83.0	71.5	74.0	71.0	76.5	≤ 200	
UF	Set value	Measured					Limitation [ms]	Remark
No.		Trip value						
1	47.5Hz	47.49	47.49	47.49	47.49	47.50	+/-0.05Hz	1, applying ramp test, start of >47.6Hz, and ramp to <47.4Hz, step frequency length is <0.025 Hz, and step time is >400ms 2, applying Jump test, start of >47.6Hz, and jump to <47.4Hz, step frequency length is >0.2Hz, and step time is >400ms
2	100ms	99.8	97.4	91.8	80.6	86.0	≤ 200	

OV Stage 2:

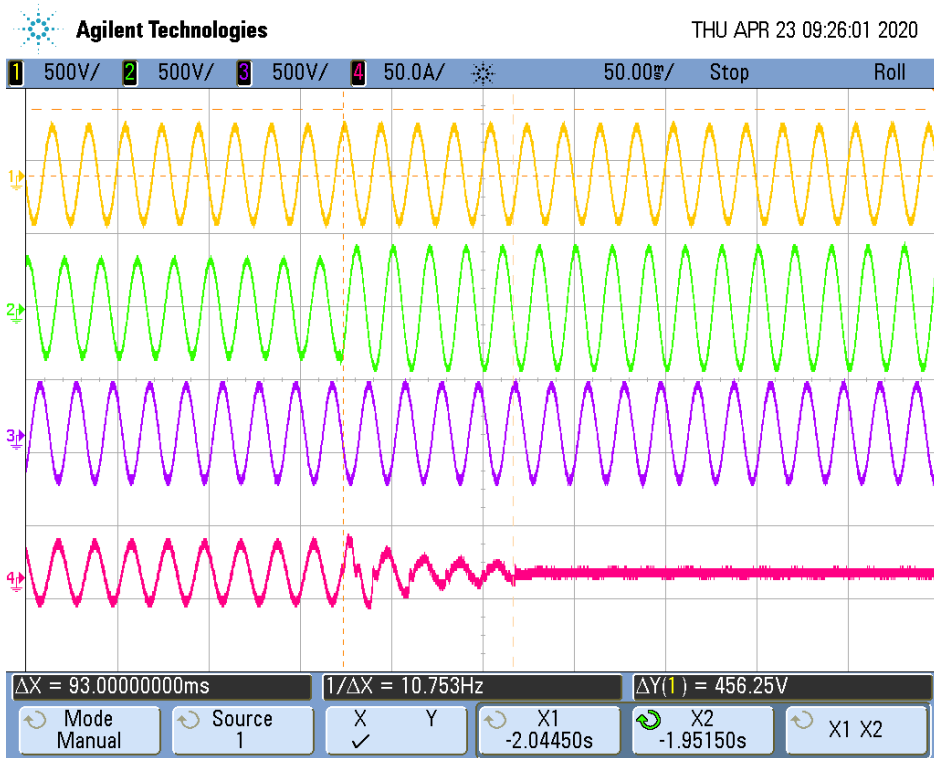

OV Stage 1:

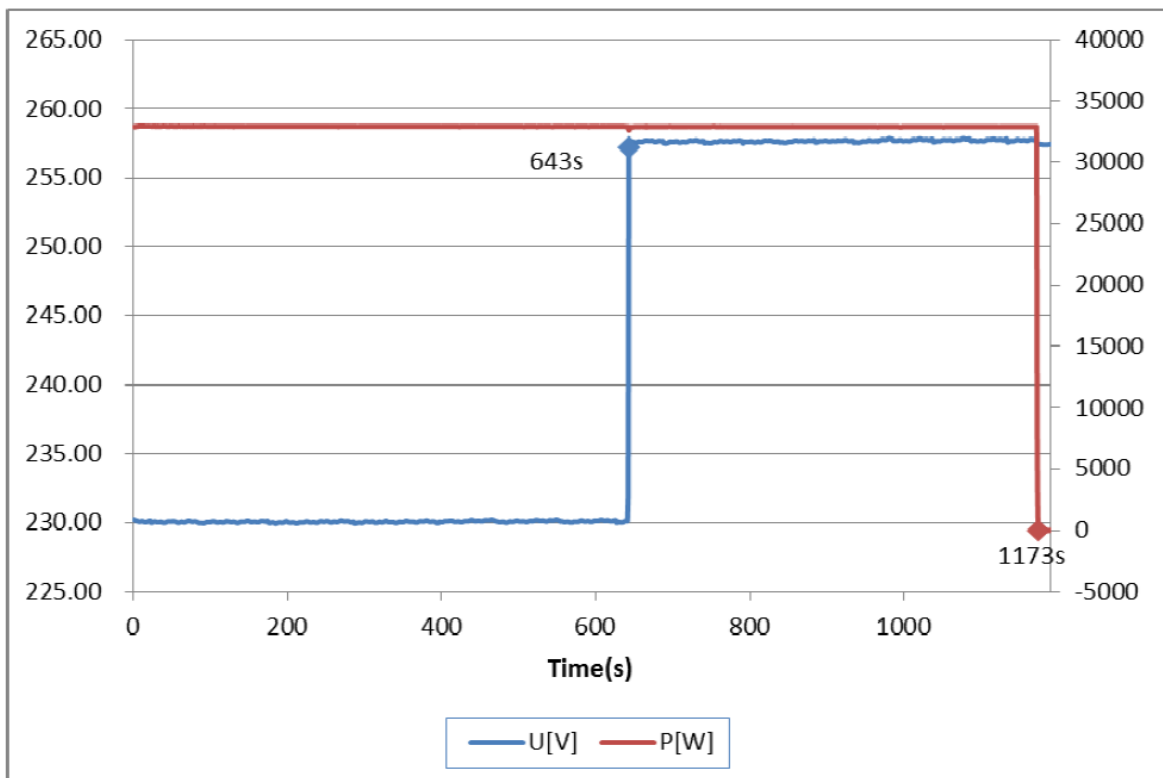

Un to 112% Un



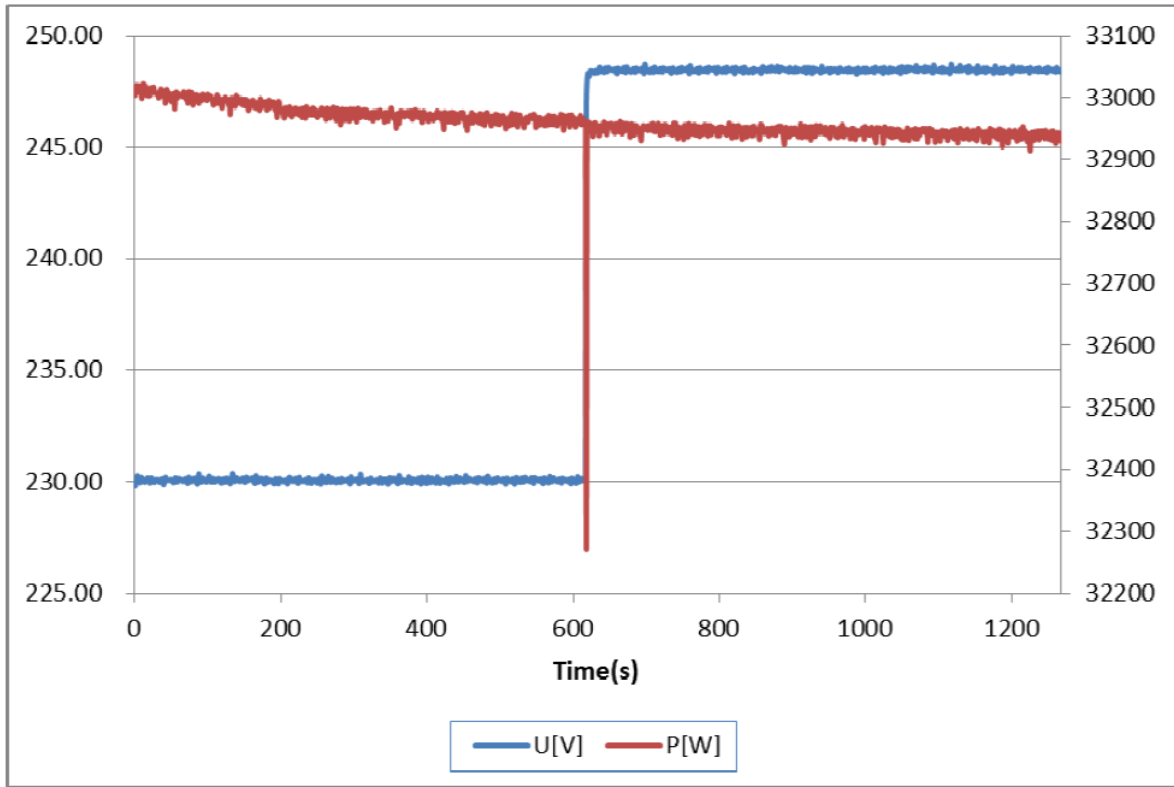

Un to 1.08Un

Graph of test c) Voltage set to 106 % Un, thereafter 114% Un:

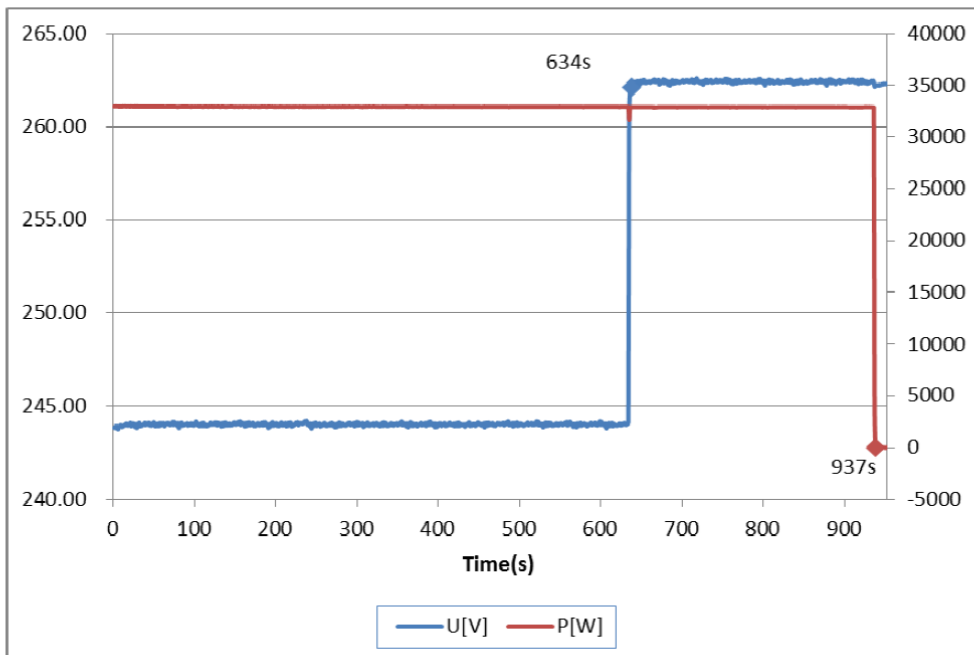

1.06 Un to 1.14Un

UV Stage 2

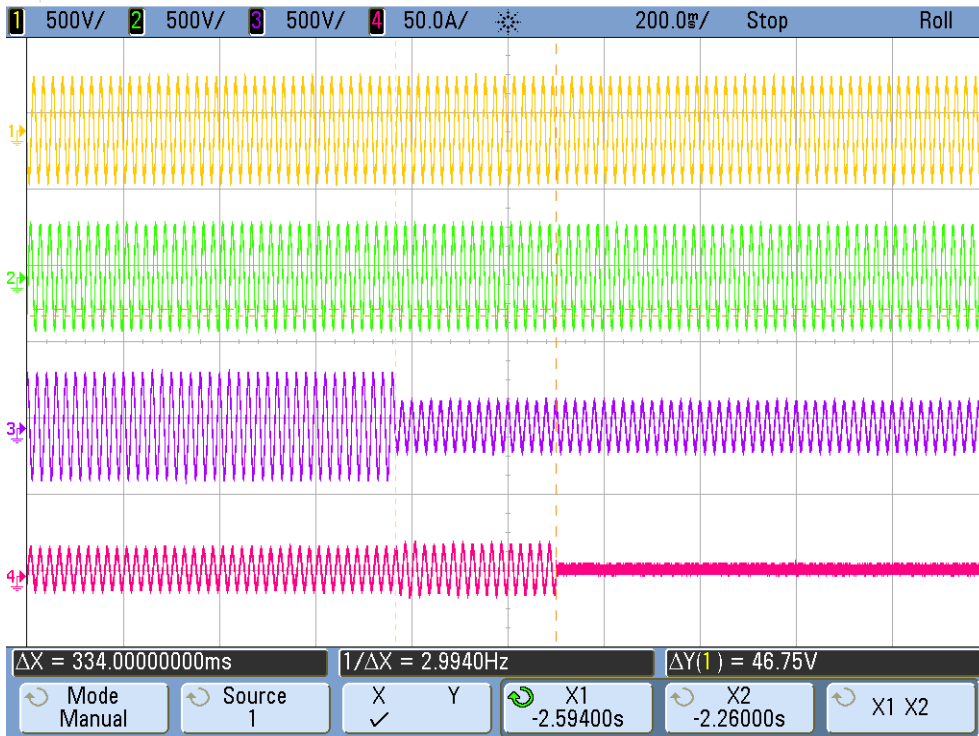

UV Stage 1

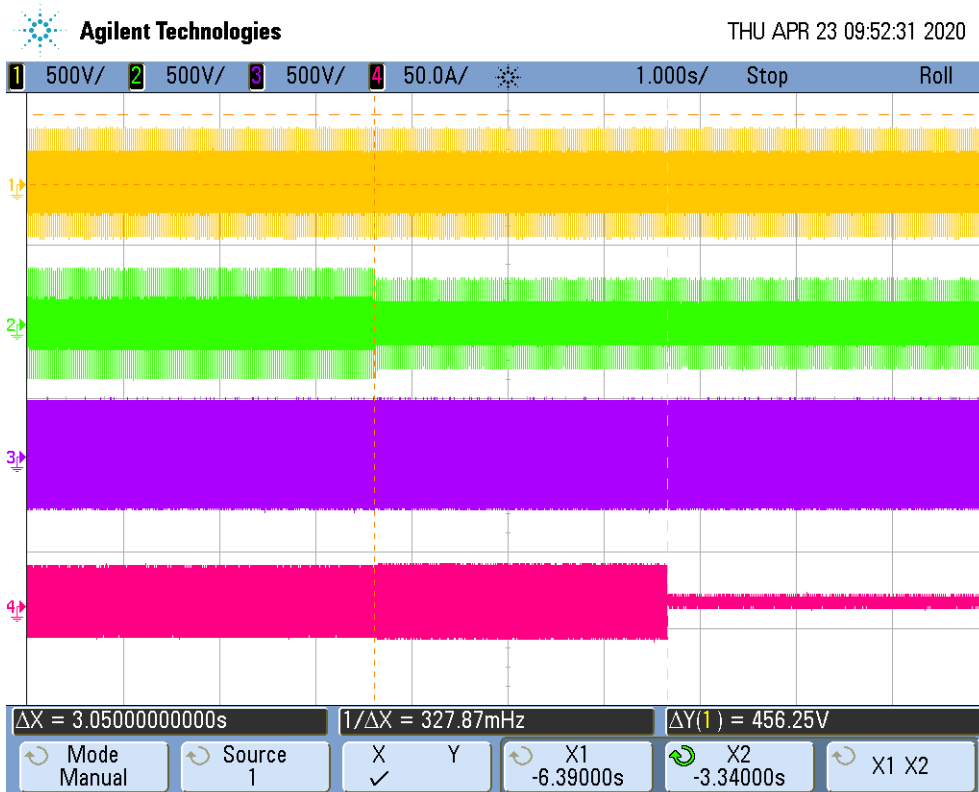

OF:

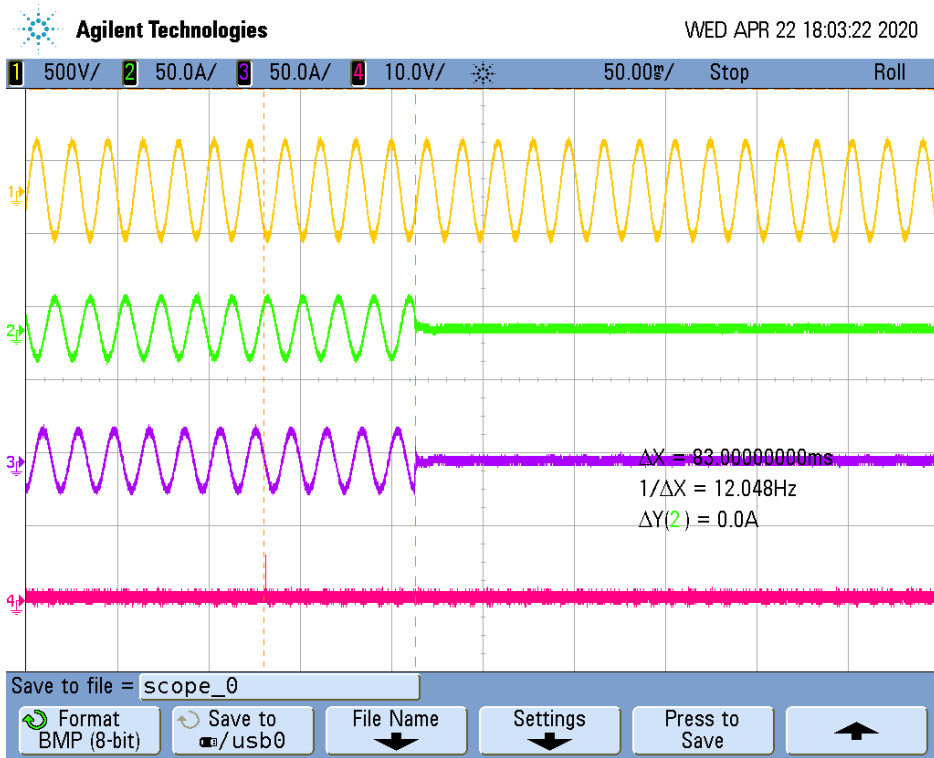

UF:

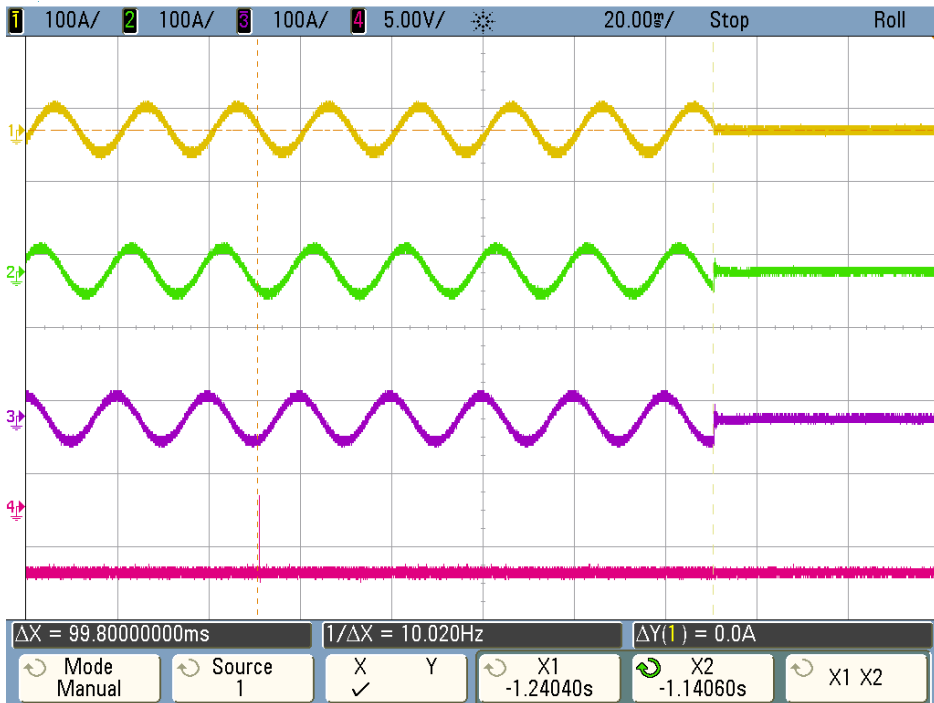

5.5.8, 5.5.9	TABLE: Indication / protection of NS protection	P
1.	The last 5 fault indication can be read	<input checked="" type="checkbox"/> Pass <input type="checkbox"/> Failed
	Fault 1:	Error message display
	Fault 2:	Error message display
	Fault 3:	Error message display
	Fault 4:	Error message display
	Fault 5:	Error message display
2.	Fault indication can be read after a supply interruption $\leq$ 3s	<input checked="" type="checkbox"/> Pass <input type="checkbox"/> Failed
	Fault 1:	Error message display
	Fault 2:	Error message display
	Fault 3:	Error message display
	Fault 4:	Error message display
	Fault 5:	Error message display
3.	The protection settings can be read on PGU or data interface equipment	<input checked="" type="checkbox"/> Pass <input type="checkbox"/> Failed Interface equipment: remote monitor
4.	The NS protection settings shall be protected.	<input checked="" type="checkbox"/> Pass <input type="checkbox"/> Failed Protection type: Integrated NS protection
5.	If all protection settings are fixed	<input checked="" type="checkbox"/> Pass <input type="checkbox"/> Failed

5.5.10		Island detection							P
No.	PEUT <sup>1)</sup> (% of EUT rating)	Reactive load (% of QL in 6.1.d)1)	PAC <sup>2)</sup> (% of nominal)	QAC <sup>3)</sup> (% of nominal)	Run on time (s)	PEUT (kW)	Actual Qf	VDC	Remarks <sup>4)</sup>
1	100	100	0	0	992.0	25.04	1.00	850	Test A at BL
2	66	66	0	0	779.0	16.66	1.00	600	Test B at BL
3	33	33	0	0	930.0	8.28	1.00	300	Test C at BL
4	100	100	-5	-5	523.0	25.04	0.98	850	Test A at IB
5	100	100	-5	0	663.0	25.04	0.95	850	Test A at IB
6	100	100	-5	5	637.0	25.04	0.93	850	Test A at IB
7	100	100	0	-5	956.0	25.04	1.03	850	Test A at IB
8	100	100	0	5	534.0	25.04	0.97	850	Test A at IB
9	100	100	5	-5	557.0	25.04	1.02	850	Test A at IB
10	100	100	5	0	951.0	25.04	1.08	850	Test A at IB
11	100	100	5	5	695.0	25.04	1.04	850	Test A at IB
12	66	66	0	-5	854.0	16.66	1.02	600	Test B at IB
13	66	66	0	-4	876.0	16.66	1.02	600	Test B at IB
14	66	66	0	-3	887.0	16.66	1.02	600	Test B at IB
15	66	66	0	-2	972.0	16.66	1.01	600	Test B at IB
16	66	66	0	-1	630.0	16.66	1.01	600	Test B at IB
17	66	66	0	1	992.0	16.66	0.99	600	Test B at IB
18	66	66	0	2	903.0	16.66	0.99	600	Test B at IB
19	66	66	0	3	979.0	16.66	0.98	600	Test B at IB
20	66	66	0	4	985.0	16.66	0.98	600	Test B at IB
21	66	66	0	5	946.0	16.66	0.97	600	Test B at IB
22	33	33	0	-5	916.0	8.28	1.03	300	Test C at IB
23	33	33	0	-4	930.0	8.28	1.03	300	Test C at IB
24	33	33	0	-3	905.0	8.28	1.02	300	Test C at IB
25	33	33	0	-2	946.0	8.28	1.01	300	Test C at IB
26	33	33	0	-1	836.0	8.28	1.01	300	Test C at IB
27	33	33	0	1	992.0	8.28	0.99	300	Test C at IB
28	33	33	0	2	984.0	8.28	0.99	300	Test C at IB
29	33	33	0	3	943.0	8.28	0.99	300	Test C at IB
30	33	33	0	4	953.0	8.28	0.98	300	Test C at IB
31	33	33	0	5	950.0	8.28	0.98	300	Test C at IB

Remark:

- 1) PEUT: EUT output power
- 2) PAC: Real power flow at S1 in Figure 1. Positive means power from EUT to utility. Nominal is the 0% test condition value.
- 3) QAC: Reactive power flow at S1 in Figure 1. Positive means power from EUT to utility. Nominal is the 0% test condition value.
- 4) BL: Balance condition, IB: Imbalance condition.
- 5) \*Note: test condition A (100%): If any of the recorded run-on times are longer than the one recorded for the rated balance condition, i.e. test procedure 6.1 f), then the non-shaded parameter combinations (no.32~47) also require testing.

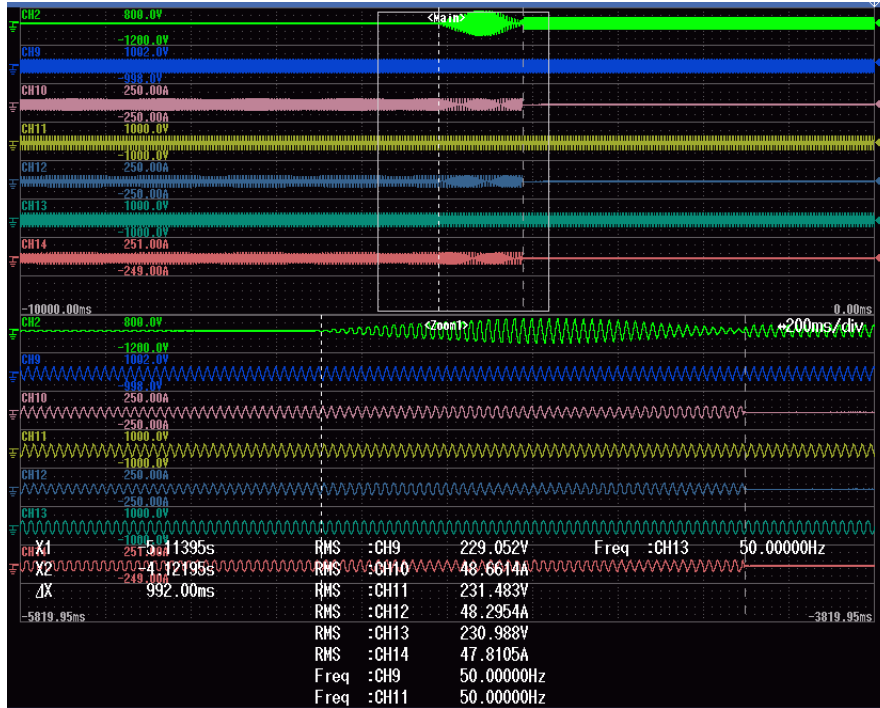

$P_{EUT} 100\%$ ,  $P_{AC} 0\%$ ,  $Q_{AC} 0\%$ , = 992ms

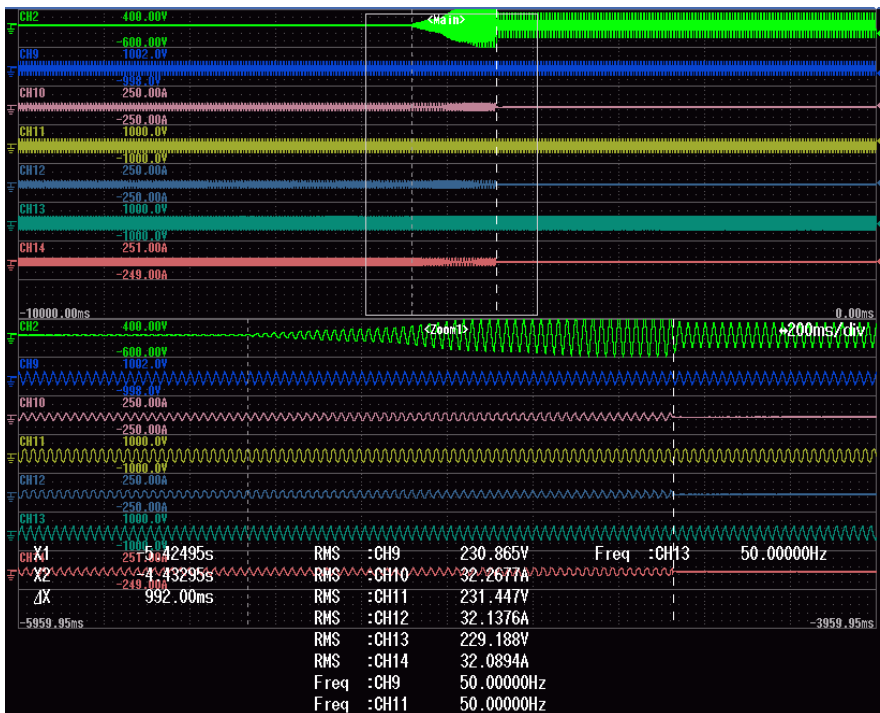

$P_{EUT} 66\%$ ,  $P_{AC} 0\%$ ,  $Q_{AC} 1\%$ , = 992.0ms

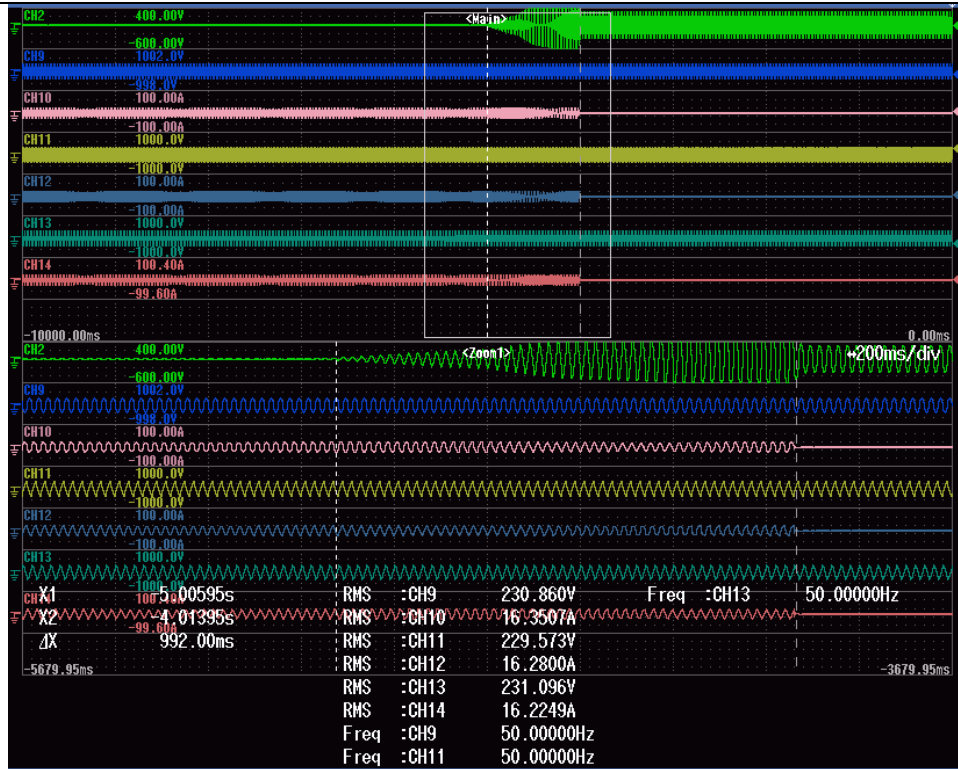

$P_{EUT} 33\%$ ,  $P_{AC} 0\%$ ,  $Q_{AC} 1\%$ , = 992.0ms

Note: CH10,CH12,CH14 denotes current of EUT; CH2 denotes Voltage of signal (the signal from switch), CH9,CH11,CH13 denotes Voltage of Grid

5.6	Connection conditions and synchronization		<b>P</b>
DC input:		AC output:	Rated Output Power
600Vdc		230Vac; 50Hz	33.0kW
Measure Item	Reconnection?		Reconnection Time (>60s)
$f_{ist} < 47.45\text{Hz}$	<input type="checkbox"/> Yes	<input checked="" type="checkbox"/> No	Cannot reconnection
$f_{ist} \geq 47.55\text{Hz}$	<input checked="" type="checkbox"/> Yes	<input type="checkbox"/> No	65.0s
$f_{ist} > 50.15\text{Hz}$	<input type="checkbox"/> Yes	<input checked="" type="checkbox"/> No	Cannot reconnection
$f_{ist} \leq 50.05\text{Hz}$	<input checked="" type="checkbox"/> Yes	<input type="checkbox"/> No	75.0s
$U_{ist} < 84\% U_n$	<input type="checkbox"/> Yes	<input checked="" type="checkbox"/> No	Cannot reconnection
$U_{ist} \geq 86\% U_n$	<input checked="" type="checkbox"/> Yes	<input type="checkbox"/> No	67.0s
$U_{ist} > 111\% U_n$	<input type="checkbox"/> Yes	<input checked="" type="checkbox"/> No	Cannot reconnection
$U_{ist} \leq 109\% U_n$	<input checked="" type="checkbox"/> Yes	<input type="checkbox"/> No	71.0s



Graph of the gradual power supply and reconnection: for 47.55Hz

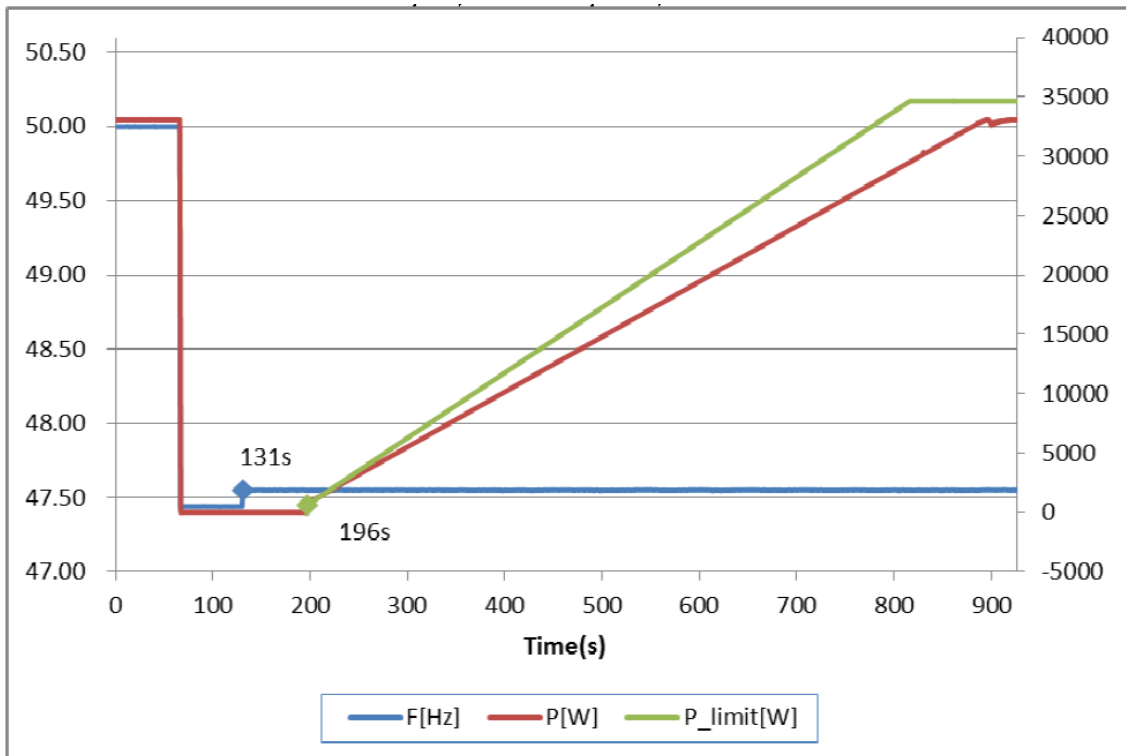

Graph of the gradual power supply and reconnection: for 50.05Hz

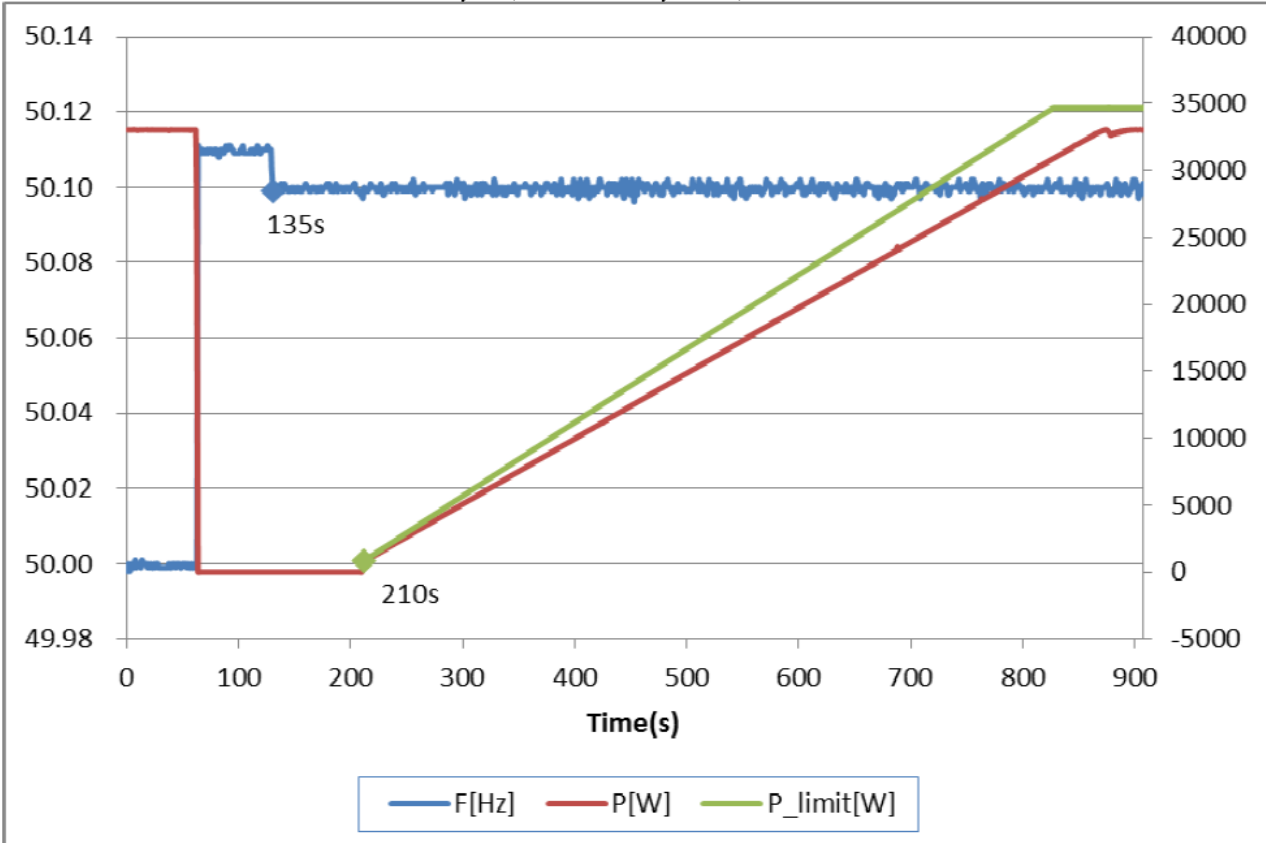

Graph of the gradual power supply and reconnection: for 86%Un

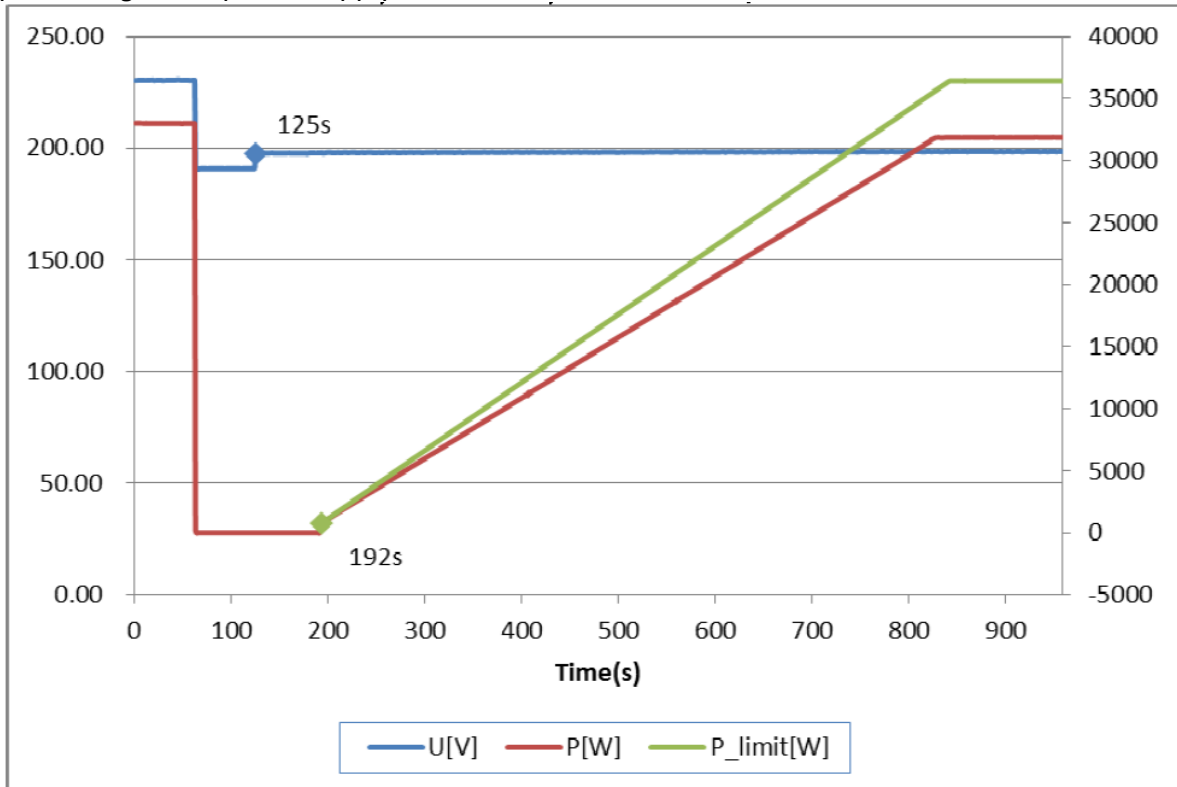

Graph of the gradual power supply and reconnection: for 109%Un

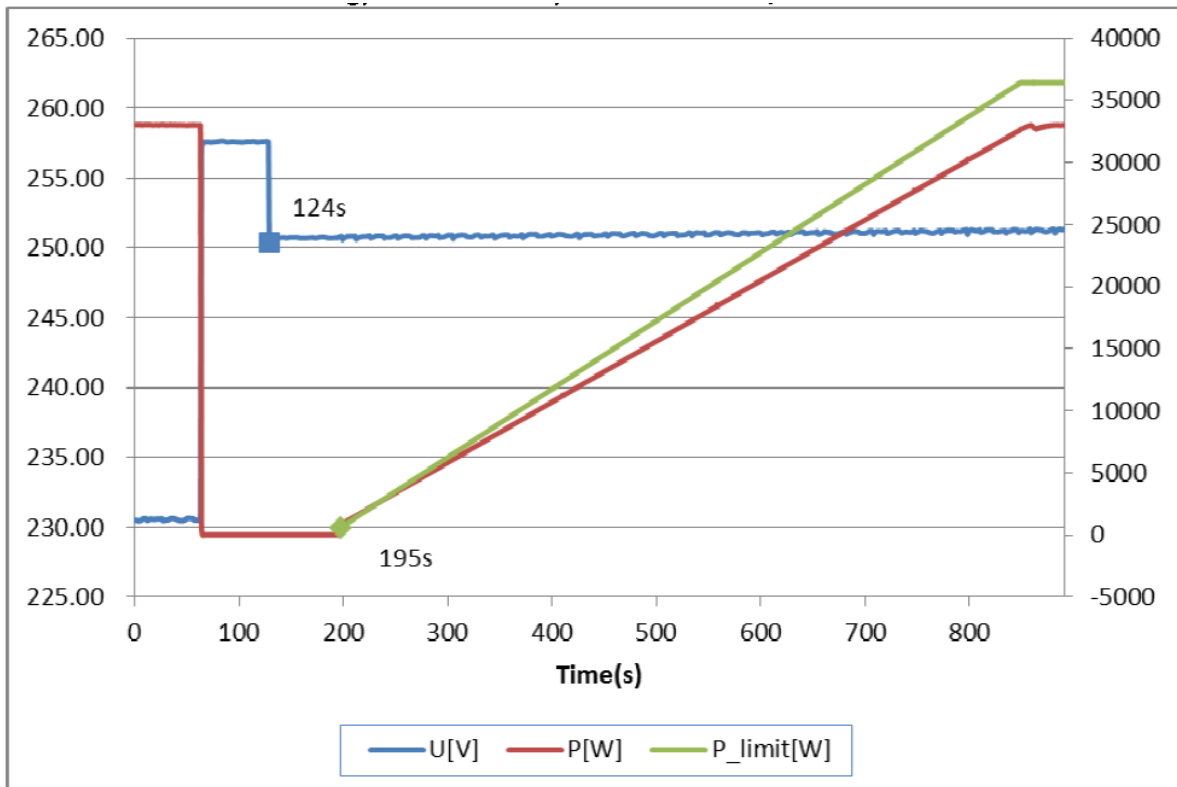

5.8	Dynamic Network support	P
-----	-------------------------	---

**Test equipment:**

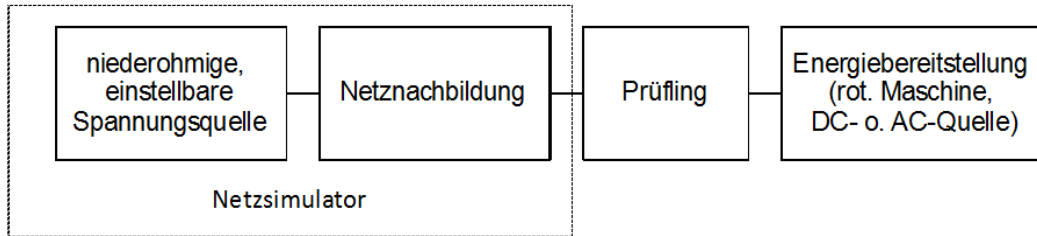

The effective network impedance from view of PGU must fulfill following criterion:

- short-circuited power at PGU before and after fault must be between 10xSn and 30xSn
- R/X 0.3-3 (for applied impedance in test equipment)

The test equipment and network simulator must be able to take the max. occurring PGU current, both in generating and motoring area. The energy absorb shall be designed for sudden short circuited current Ip (per IEC 60909). Ip is obvious different by the type of test sample, the correct value shall be:

- for inverter coupled system about 2.2In,
- for direct coupled Asynchronous or Synchronous machines about 7In.

**Grid simulator settings for asymmetry grid fault:**

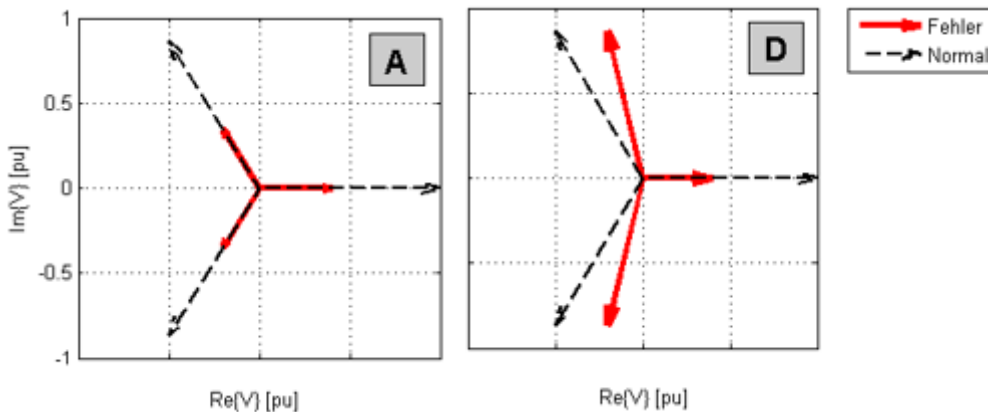

D1	Test Equipment	Test Sample
Connection terminal	U	L1
	V	L2
	<b>W</b>	L3 (L for single phase)
D2	Test Equipment	Test Sample
Connection terminal	U	L3
	<b>V</b>	L1 (L for single phase)
	W	L2

VDE No.	U	V	W	Type	Remark
--	1.00, -150°	1.00, 90°	1.00, -30°	A	Initial status

1.3, 1.4	0.62, -173.3°	0.15, 90°	0.62, -6.9°	D	UVRT
2.3, 2.4, 3.3, 3.4	0.76, -161.1°	0.50, 90°	0.76, -19.1°	D	
4.3, 4.4	0.93, -152.8°	0.85, 89.9°	0.93, -27.4°	D	
5.3, 5.4	1.08, -144.5°	1.25, 89.1°	1.06, -36.3°	D	OVRT
6.3, 6.4	1.06, -145.5°	1.20, 89.3°	1.05, -35.1°	D	
7.3, 7.4	1.04, -146.6°	1.15, 89.4°	1.04, -33.9°	D	

**Diagram:**

For each test the following diagrams shall be figured since  $t_1-1s$  (one second before fault entry) till  $t_2+6s$  (six seconds after fault clear), zoomed if needed:

Empty load tests:

- line to line voltages and line to neutral voltages (signal)
- full period-RMS value of line to neutral voltages with updated rate of 1/ms.

Tests with sample:

- line to line voltage and line to neutral voltage (signal)
- line currents (signal)
- full period-RMS value of line to neutral voltage with updated rate of 1/ms
- full period-RMS value of line currents with updated rate of 1/ms (active and reactive part additionally)
- active power and reactive power in pos. sequence with updated rate of 1/ms
- voltage and current in pos. sequence with updated rate of 1/ms

**Test condition:**

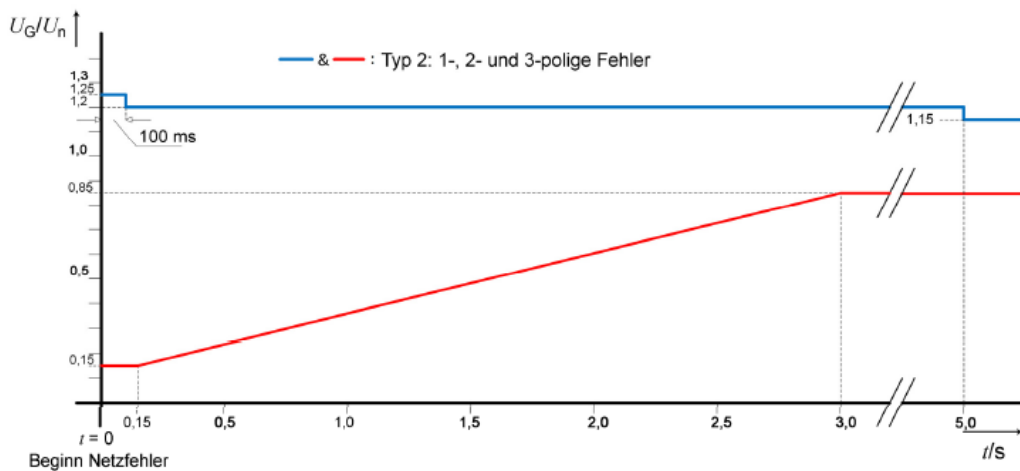

**Legende**

- & — FRT-Kurve für 1-, 2- und 3-polige Netzfehler
- UG Effektivwert der aktuellen Spannung an den Generatorklemmen

**Method of calculations:**

Notes on calculations:	Used formula	Remarks
<p>General remarks: The average grid frequency over the measured interval is calculated from zero-crossings of the sine function. Only 10 cycles before the dip are used for this calculation. RMS-Calculations are performed with a moving window, which is determined by <math>T = 1/f</math> and must remain constant. The number of samples <math>N</math> per calculation window is determined by the sampling rate <math>f_s</math>. <math>N</math> has to be even and an integer number nearest to the product <math>T \cdot f_s</math>.</p>	$\underline{U}_1 = \frac{\sqrt{2}}{N} \cdot \sum_{n=0}^N u(n) \cdot e^{-j \left( \frac{2\pi n}{N} \right)}$ $\underline{I}_1 = \frac{\sqrt{2}}{N} \cdot \sum_{n=0}^N i(n) \cdot e^{-j \left( \frac{2\pi n}{N} \right)}$	<ul style="list-style-type: none"> <li>- Calculated for each phase A,B,C</li> <li>- N: Amount of samples per window</li> <li>- n: number of sample</li> </ul>
<p>Performed Calculation</p>	$\underline{U}^+ = \frac{1}{3} \cdot (\underline{U}_{1A} + \underline{U}_{1B} \cdot e^{+j \frac{2\pi}{3}} + \underline{U}_{1C} \cdot e^{-j \frac{2\pi}{3}})$ $\underline{I}^+ = \frac{1}{3} \cdot (\underline{I}_{1A} + \underline{I}_{1B} \cdot e^{+j \frac{2\pi}{3}} + \underline{I}_{1C} \cdot e^{-j \frac{2\pi}{3}})$	
<p>Complex values for the fundamental harmonic</p>	$P = 3 \cdot U^+ \cdot I^+ \cdot \cos(\varphi)$ $Q = 3 \cdot U^+ \cdot I^+ \cdot \sin(\varphi)$	<p>Phase-angle : Angular difference between current and voltage</p> $\varphi = (\varphi_U - \varphi_I)$
<p>Positive sequence component of the voltage and current</p>	$I_r = I^+ \cdot \sin(\varphi)$ $I_{tot} = I^+$	
<p>Power:</p>	$U_{rms} = \sqrt{\frac{1}{N} \cdot \sum_{n=0}^N (u(n) - \bar{u})^2}$ $\bar{u} = \frac{1}{N} \cdot \sum_{n=0}^N u(n)$	<ul style="list-style-type: none"> <li>- Calculated for each phase A,B,C or L1, L2, L3</li> </ul>

Verification of dynamic network support								P	
Short-circuited power at generator terminal [VA]			60K						
NS protection settings			See table 5.5 for detail.						
	No.	Parameter	Phase ref.	Time ref.	unit	Result			
General Info.	0	Test number	--	--	--	1.1	2.1	3.1	4.1
	1	Date	--	--	dd.mm.yyyy	20-April-2020 to 20-May-2020			
	2	Time (start of test)	--	--	hh:mm:ss.f	See graph			
	3	Fault type (phase)	--	--		A	A	A	A
	4	Setting voltage depth	Line to line	--	p.u.	0.15	0.50	0.50	0.85
	5	Setting dip duration		--	ms	150	1500	1500	60000
	6	Point of fault entry	Total	--	ms	20ms			
	7	Point of fault clearance	Total	--	ms	20ms			
	8	Fault duration in empty load test	Total	--	ms	160.67	1502.3	1503.7	60010
	9	Voltage depth/height in empty load test	Total	t1+100ms to t2 and t1-10s to t1	p.u.	0.150	0.501	0.501	0.852
10	Positive sequence		p.u.		0.150	0.499	0.499	0.848	
Before dip <t1	11	Voltage	Line to neutral	t1-10s to t1	p.u.	1.00	1.00	1.00	1.00
	12	Current	Positive sequence	t1-500ms to t1-100ms	p.u.	1.01	1.10	1.11	1.00
	13	Active power	Total	t1-10s to t1	p.u.	1.01	0.99	1.01	1.01
	14		Positive sequence			1.01	0.99	1.01	1.01
	15	Reactive power	Total	t1-10s to t1	p.u.	-0.007	0.475	-0.492	-0.007
	16		Positive sequence			-0.007	0.475	-0.492	-0.007
	17	Cos $\phi$	--	t1-10s to t1	--	0.9999	0.9035	0.8986	0.9999
During dip t1 to	18	Voltage	Line to neutral	t1+100ms to t2-20ms	p.u.	0.15	0.50	0.50	0.85

t2	19	Line current	Phase 1	t1+60ms	p.u.	0.007	0.018	0.016	0.021
	20		Phase 2			0.009	0.019	0.020	0.029
	21		Phase 3			0.008	0.019	0.018	0.027
	22	Line current	Phase 1	t1+100ms	p.u.	0.008	0.015	0.014	0.014
	23		Phase 2			0.011	0.016	0.016	0.017
	24		Phase 3			0.009	0.016	0.015	0.016
	25	Active power	Total	t1+100ms to t2-20ms	p.u.	0.001	0.001	0.001	0.002
	26		Positive sequence			0.001	0.001	0.001	0.002
After dip > t2	27	Voltage	Line to neutral	t2+3s to t2+10s	p.u.	1.00	1.00	1.00	1.00
	28	Active power	Positive sequence.	t2+3s to t2+10s	p.u.	1.01	0.99	1.01	1.01
	29		Total			1.01	0.99	1.01	1.01
	39	Active power rising time	Positive sequence	--	s	0.148	0.195	0.198	0.146
	31	Reactive power	Positive sequence	t2+3s to t2+10s	p.u.	-0.009	0.483	-0.484	-0.008
	32		Total			-0.009	0.483	-0.484	-0.008
	33	Reactive power rising time	Positive sequence	--	s	0.148	0.195	0.198	0.146
	34	PGU does not disconnect from grid till 60s after fault	--	t2 to t2+60s	Yes / No	Yes			

Graph of Test number 1.1

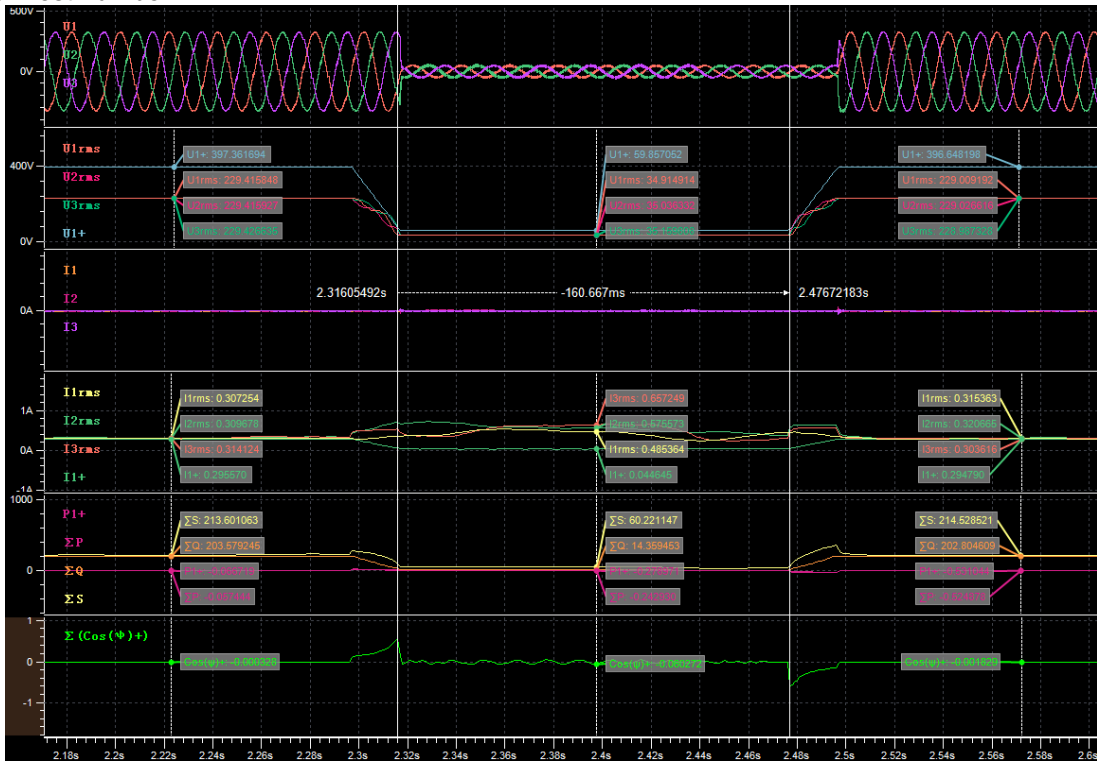

Empty load

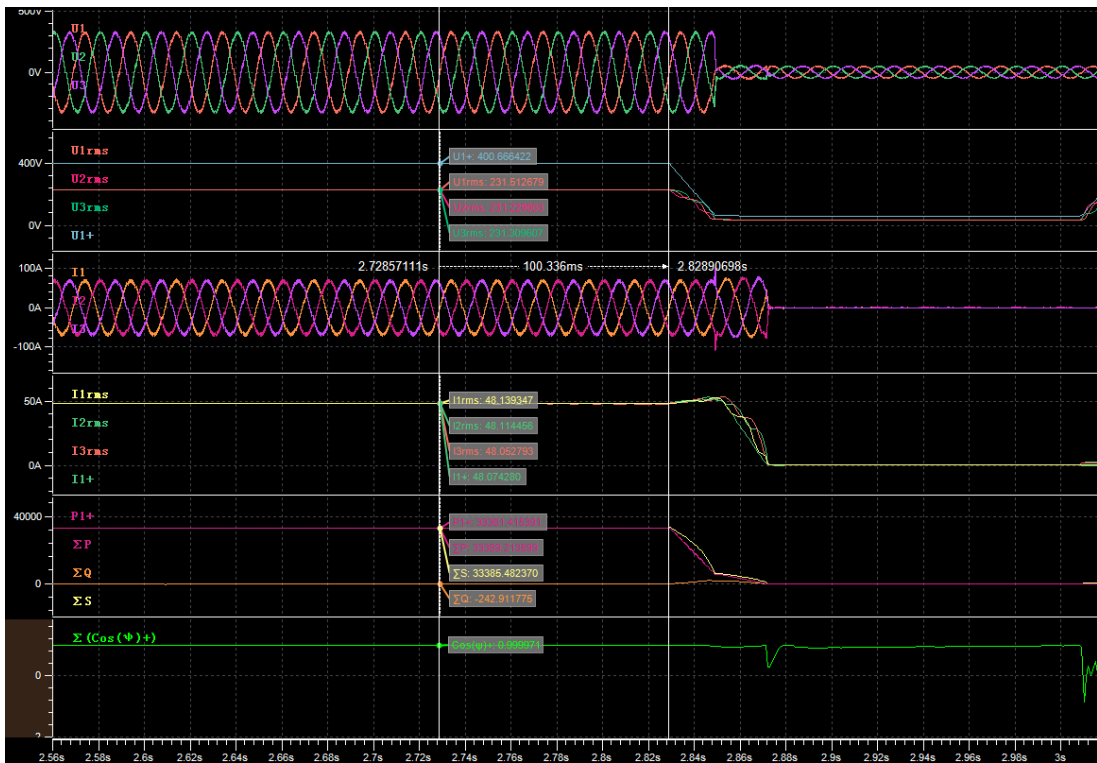

Before dip (t1-100ms)



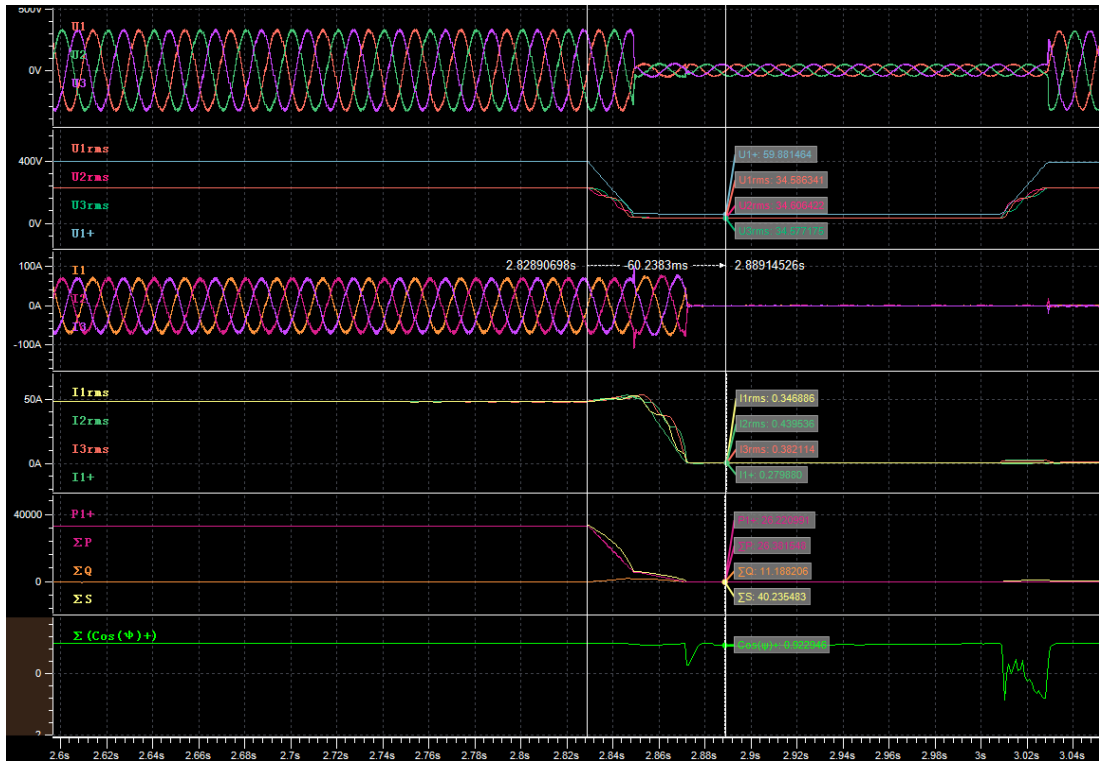

During dip (t1+60ms)

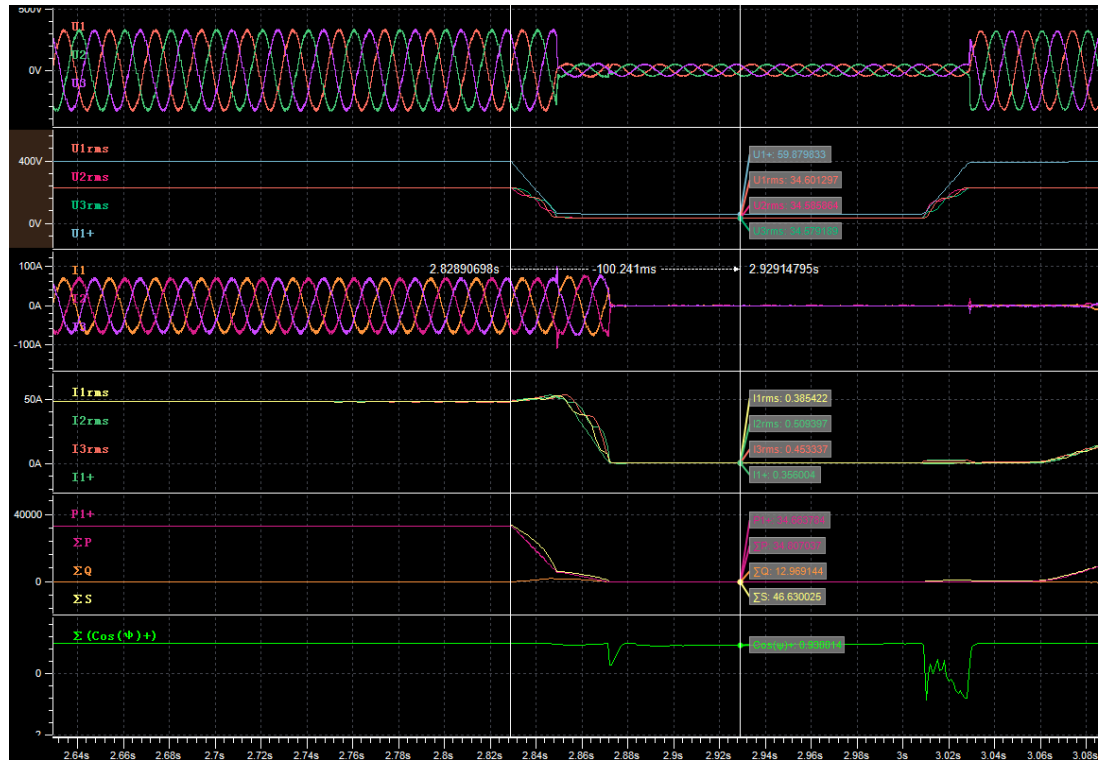

During dip (t1+100ms)

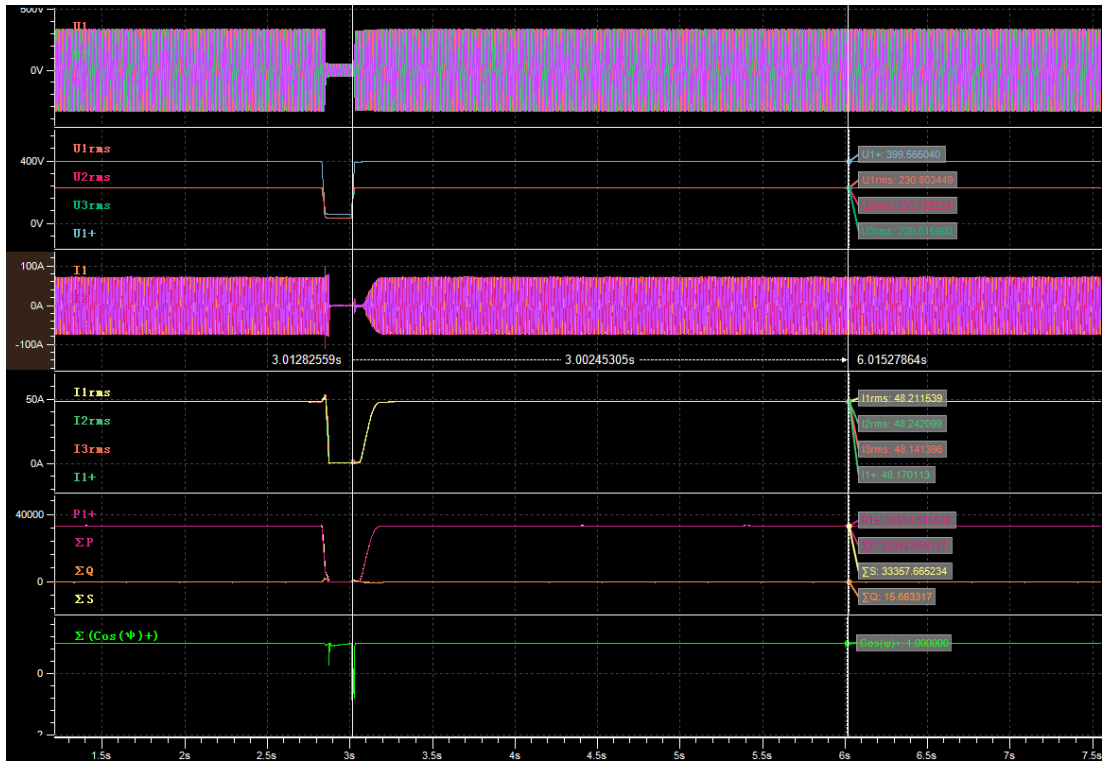

After dip (t2+3s)

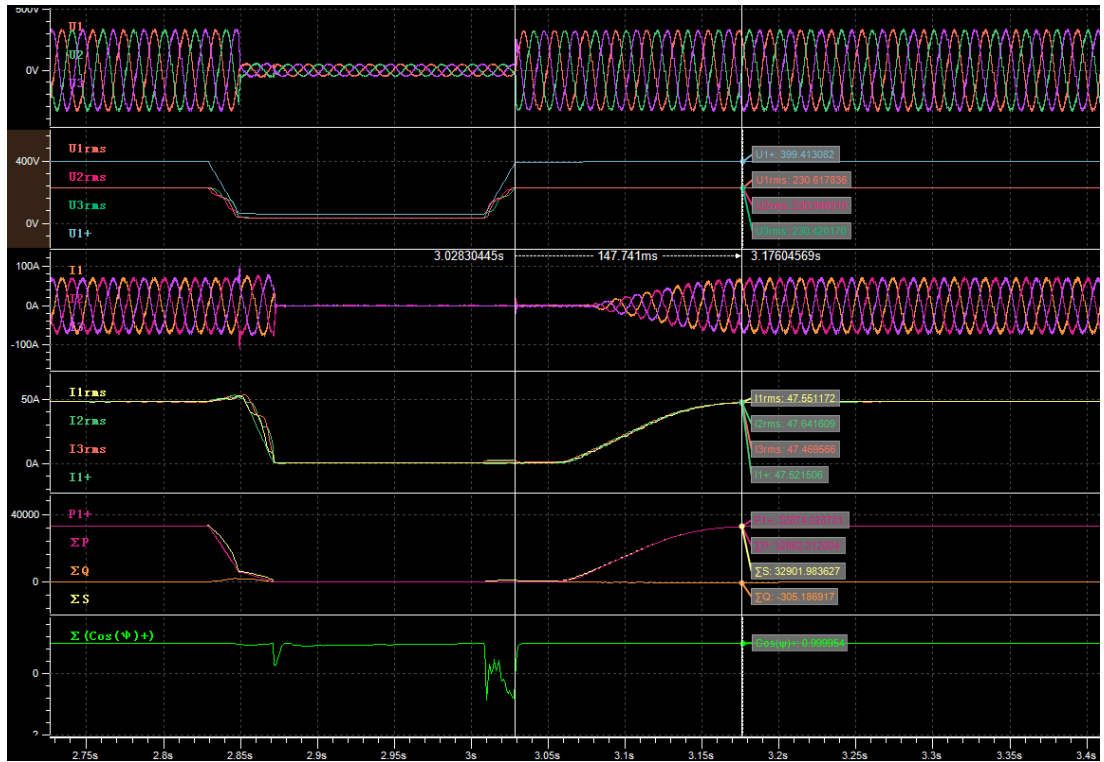

Recovery time

Graph of Test number 2.1

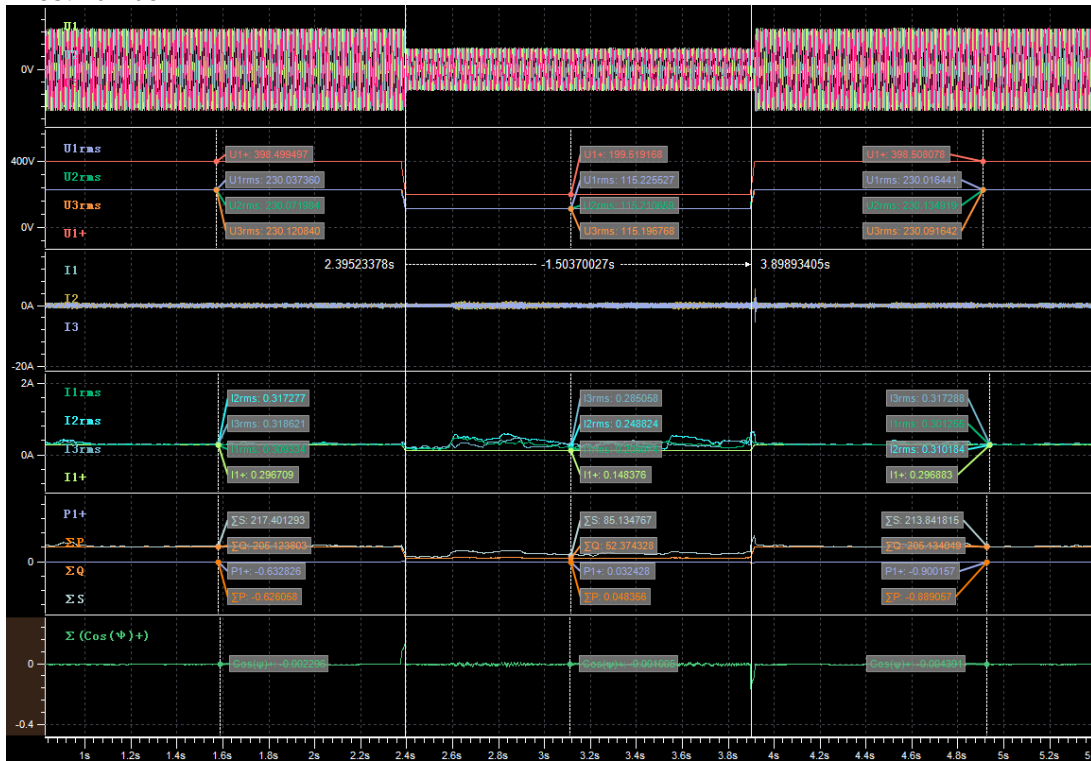

Empty load

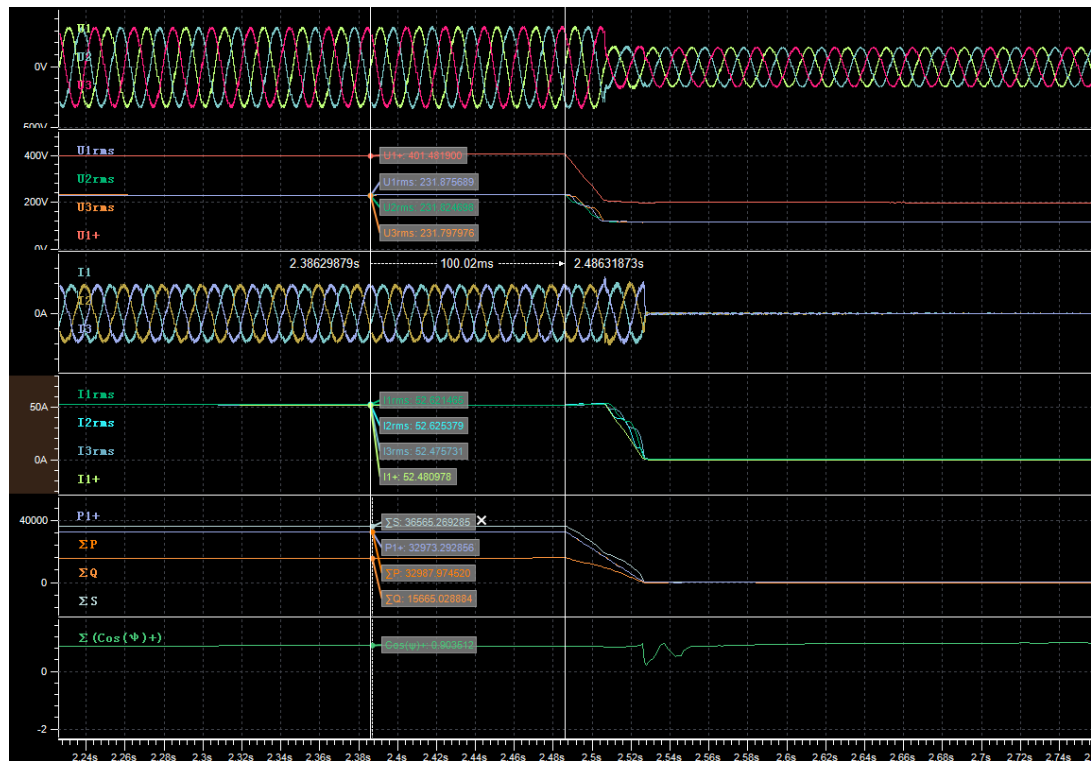

Before dip (t1-100ms)

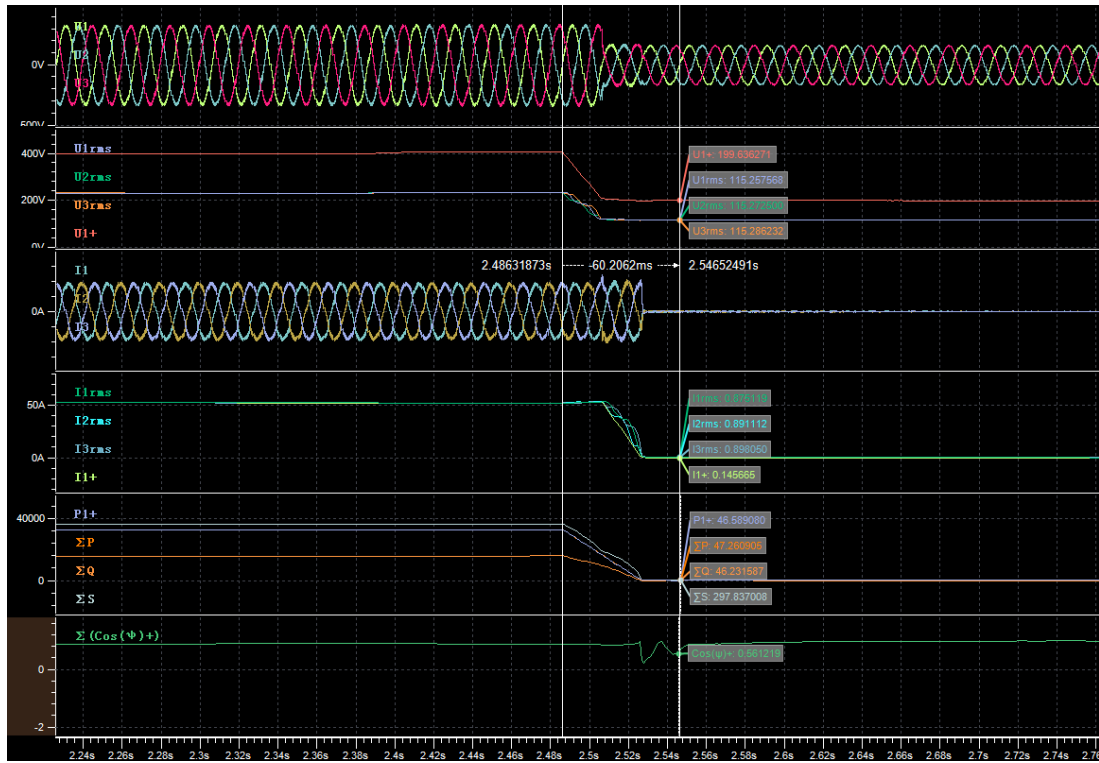

During dip (t1+60ms)

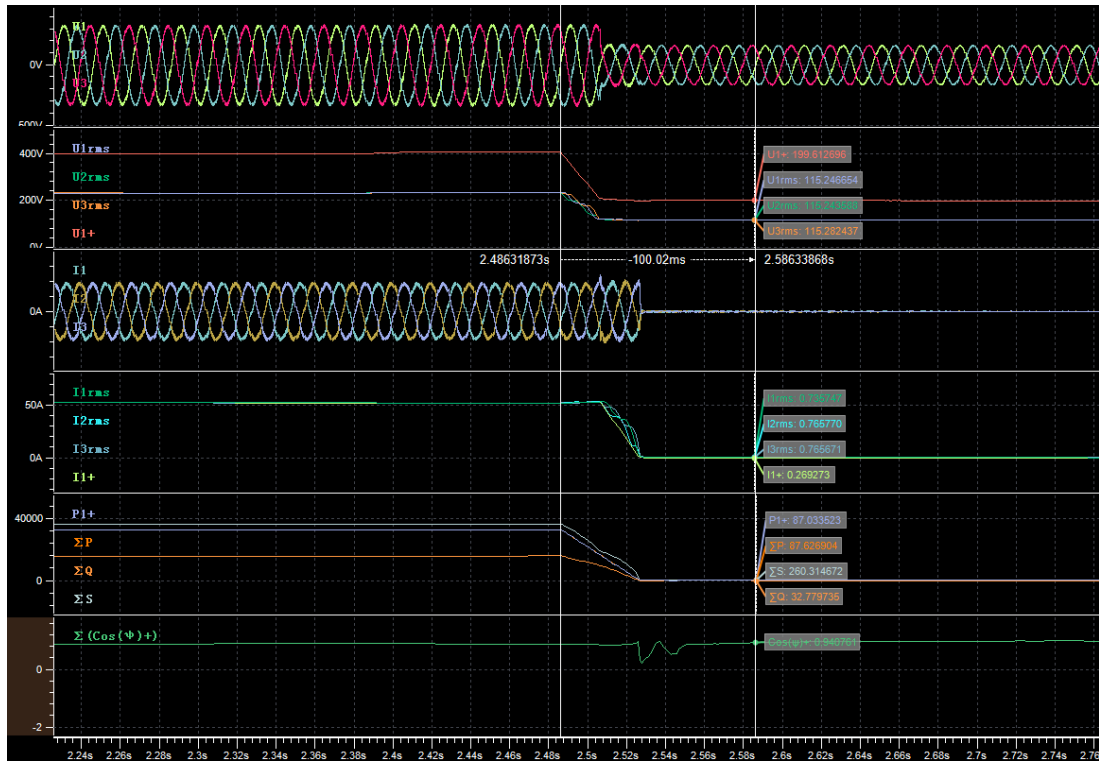

During dip (t1+100ms)

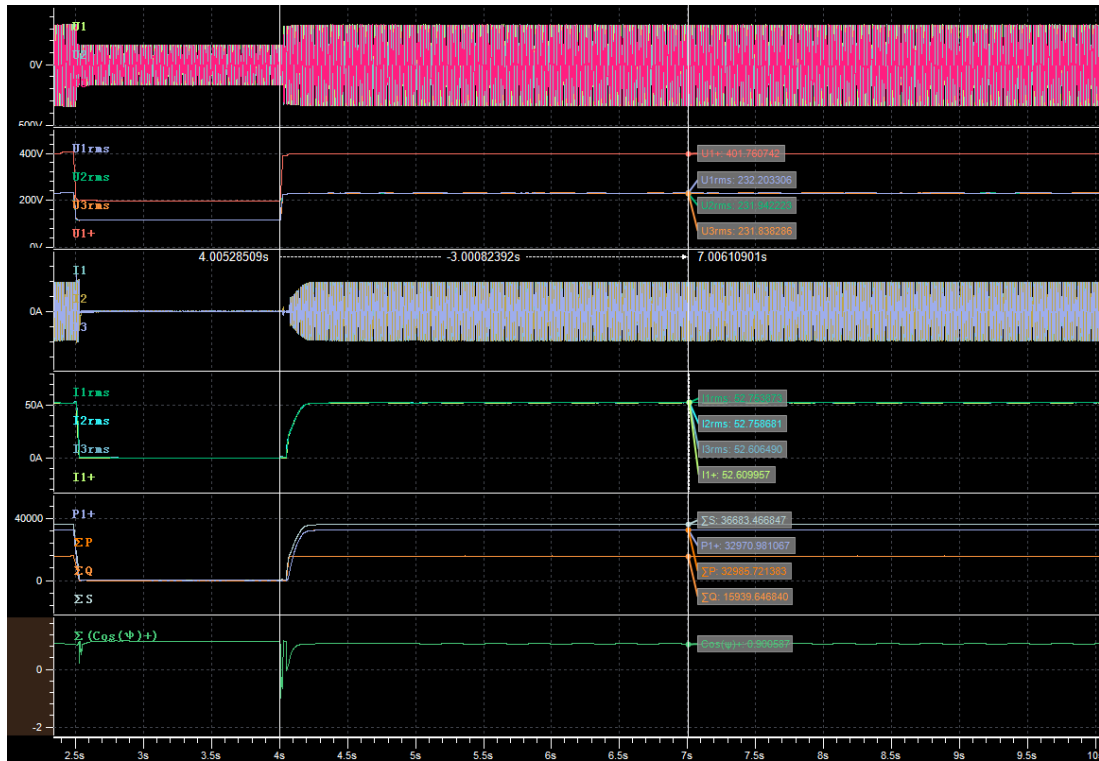

After dip (t2+3s)

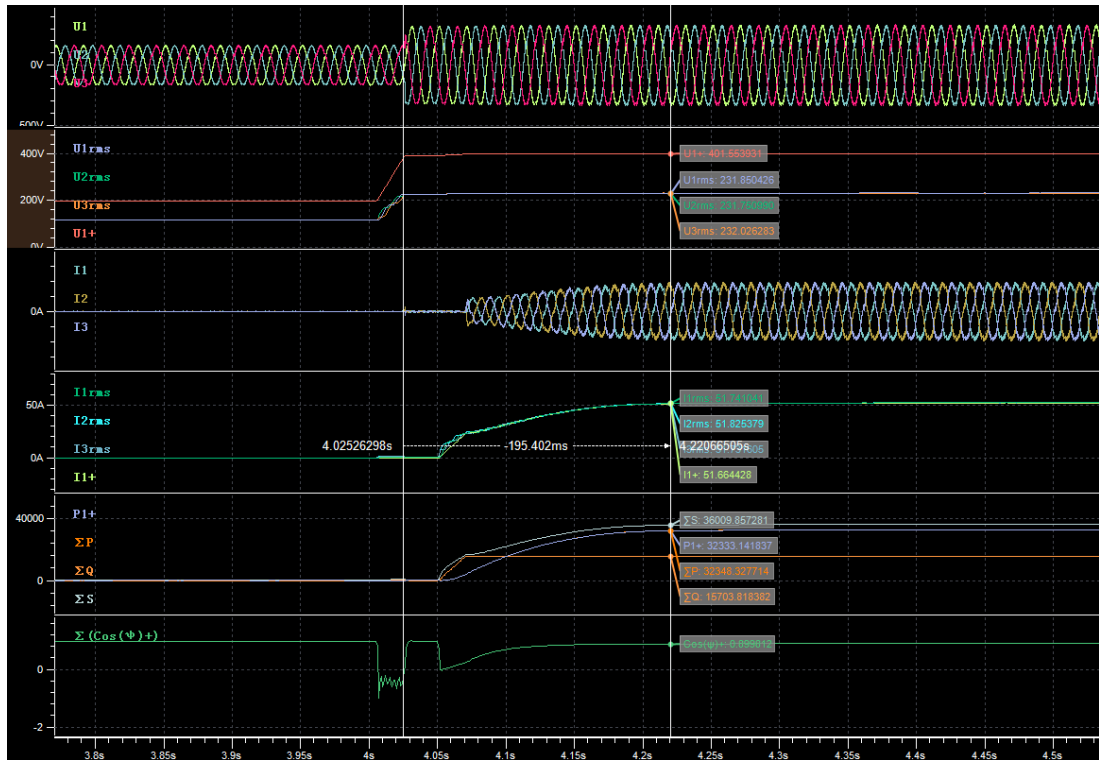

Recovery time

Graph of Test number 3.1

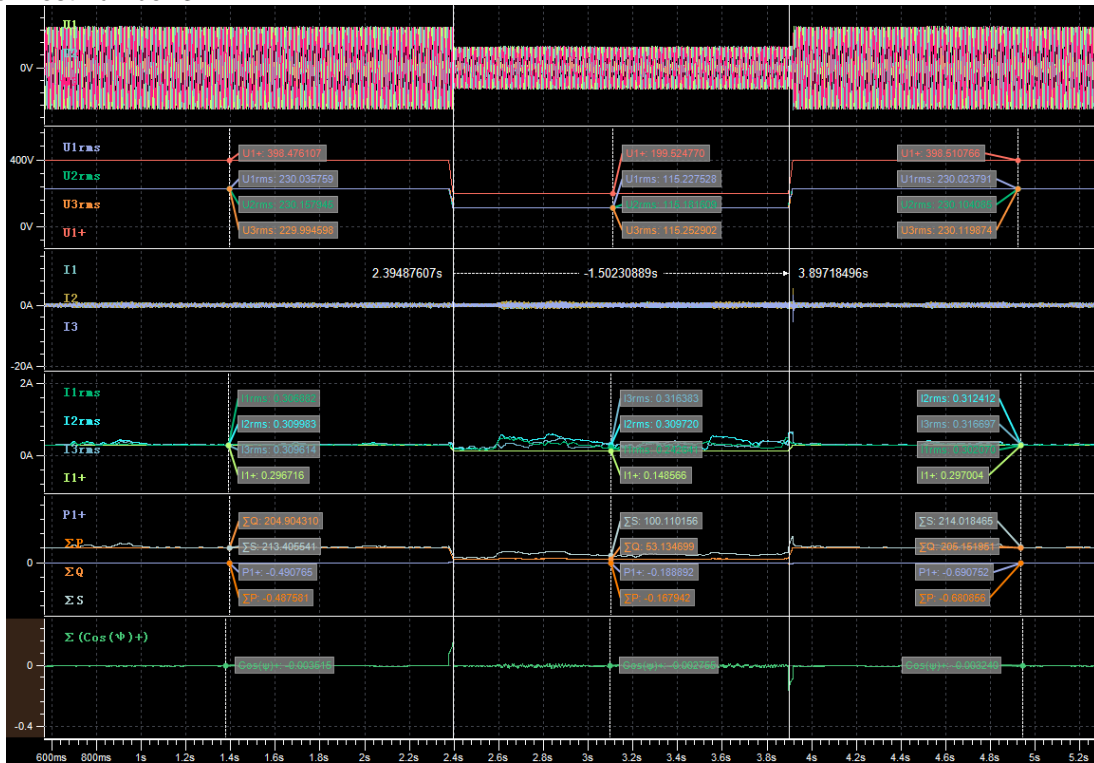

Empty load

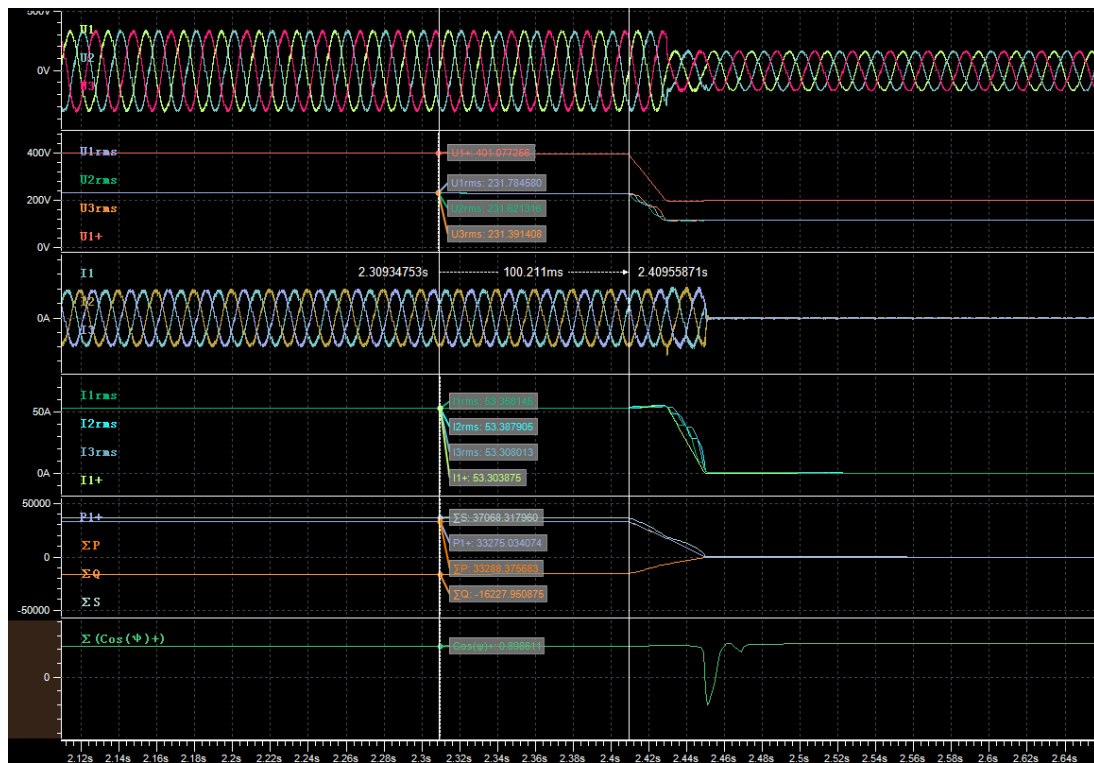

Before dip (t1-100ms)

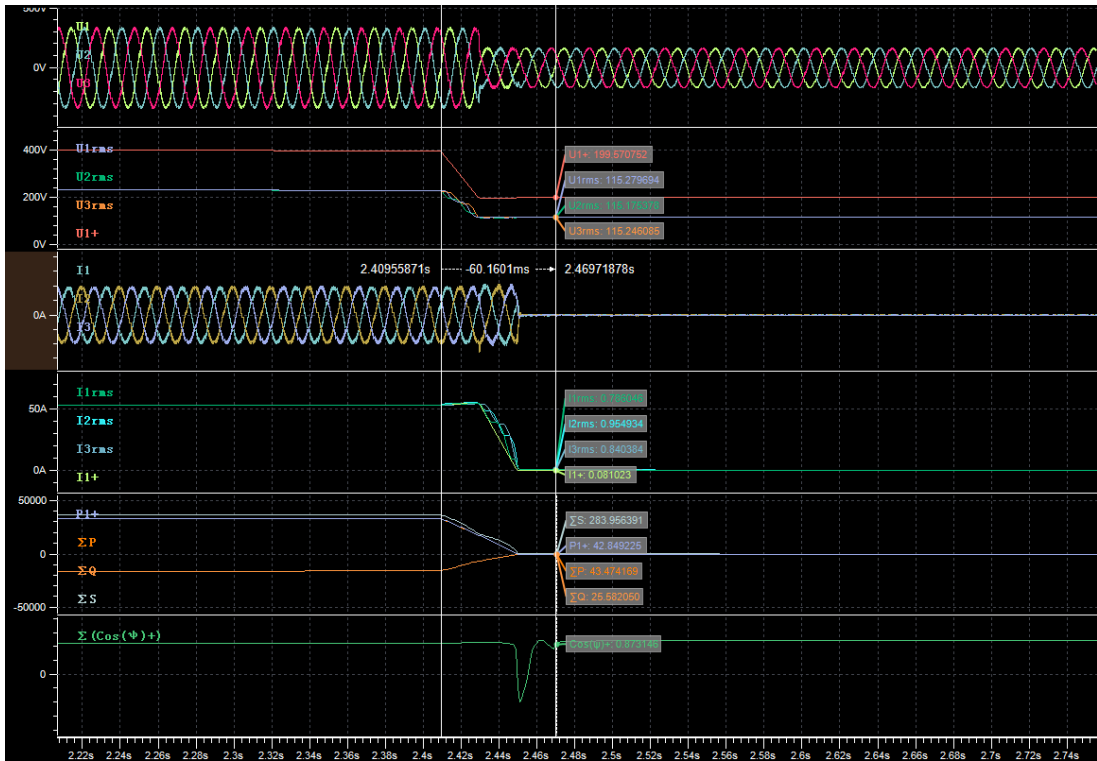

During dip (t1+60ms)

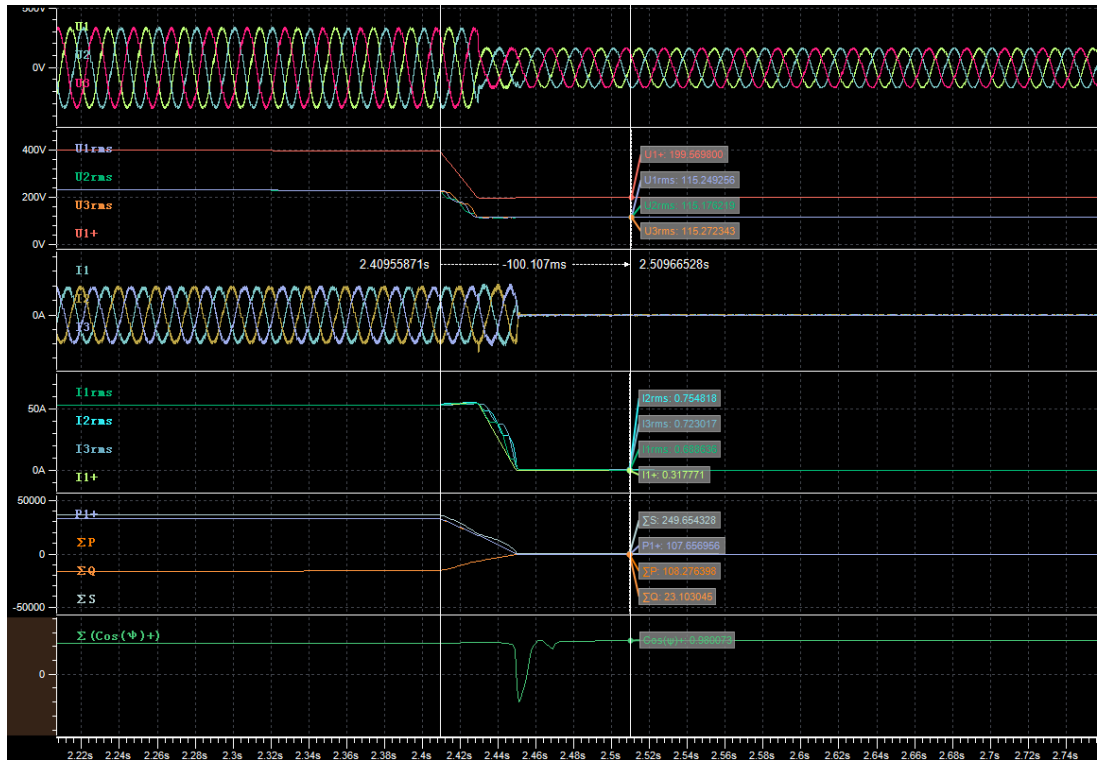

During dip (t1+100ms)

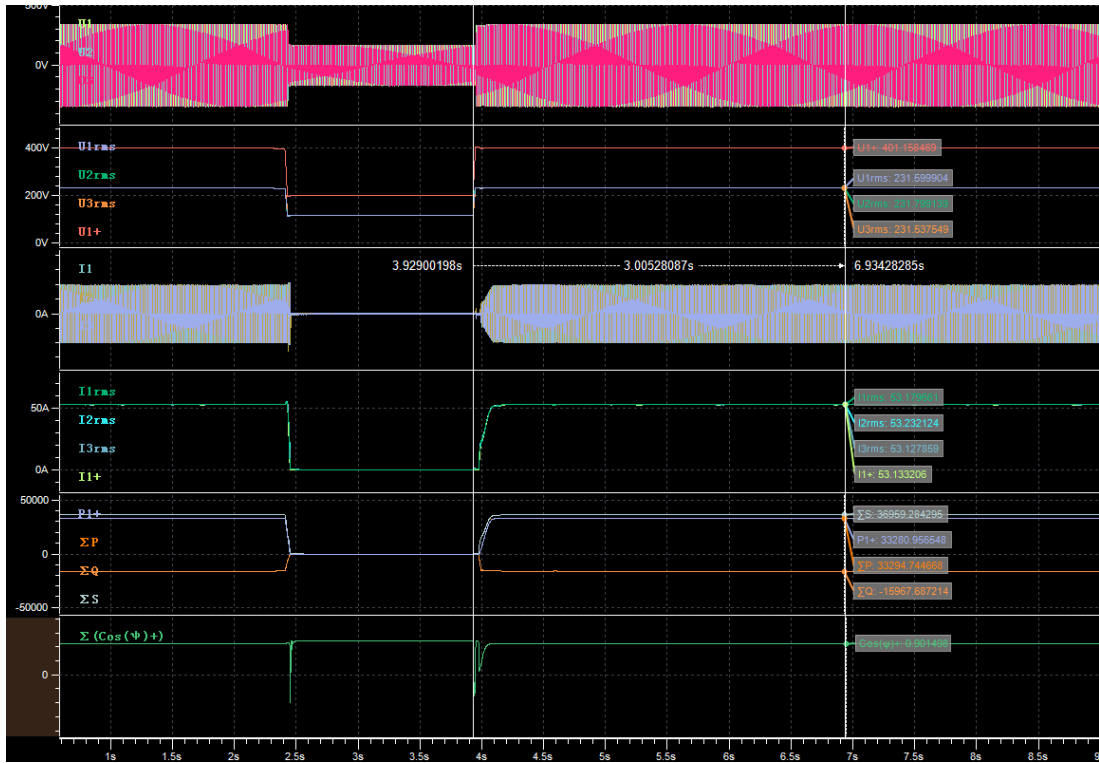

After dip (t2+3s)

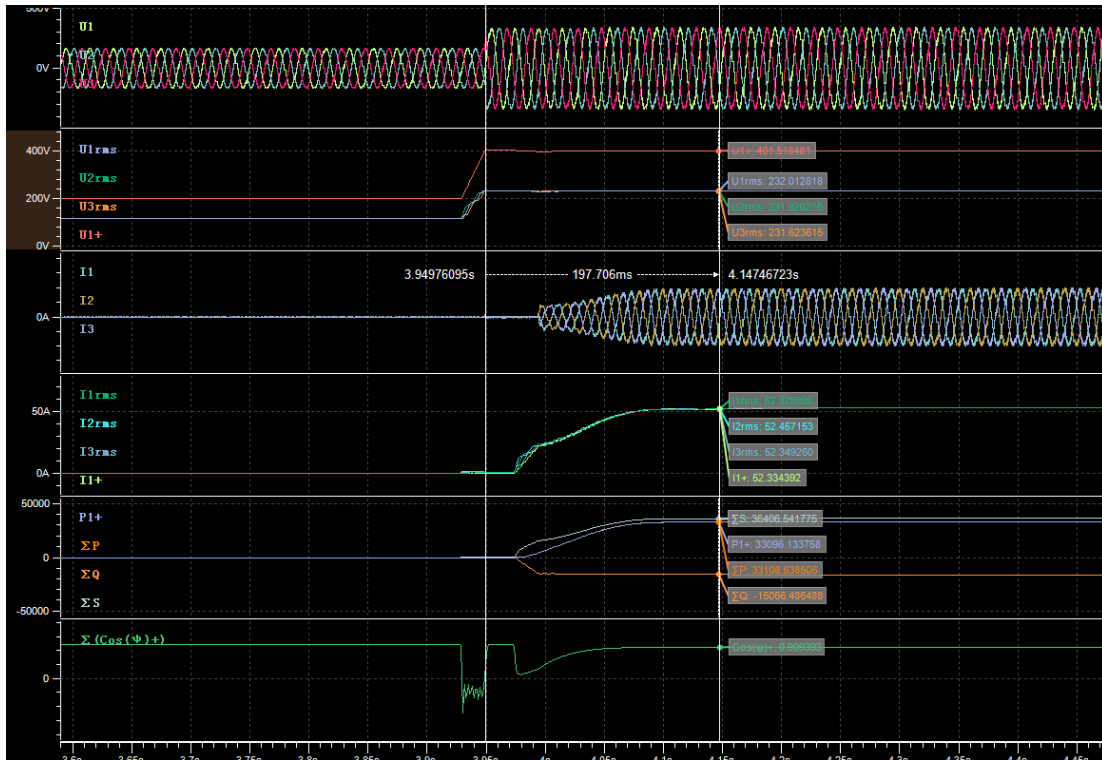

Recovery time



Graph of Test number 4.1

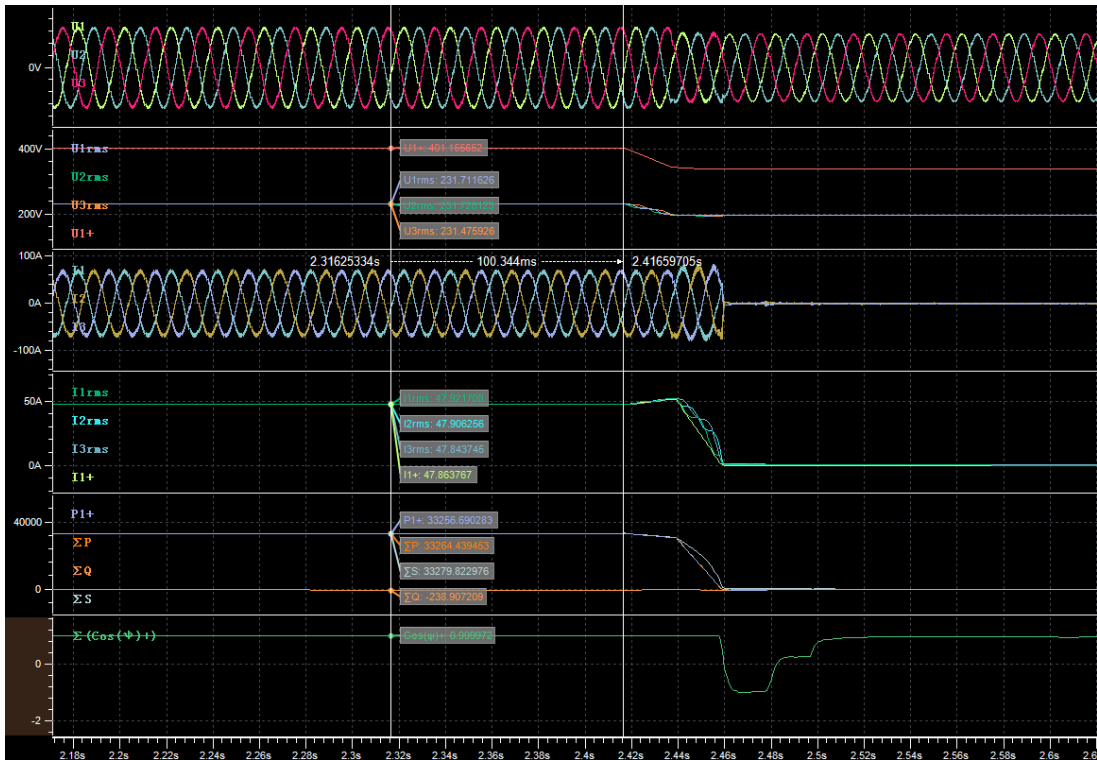

Before dip (t1-100ms)

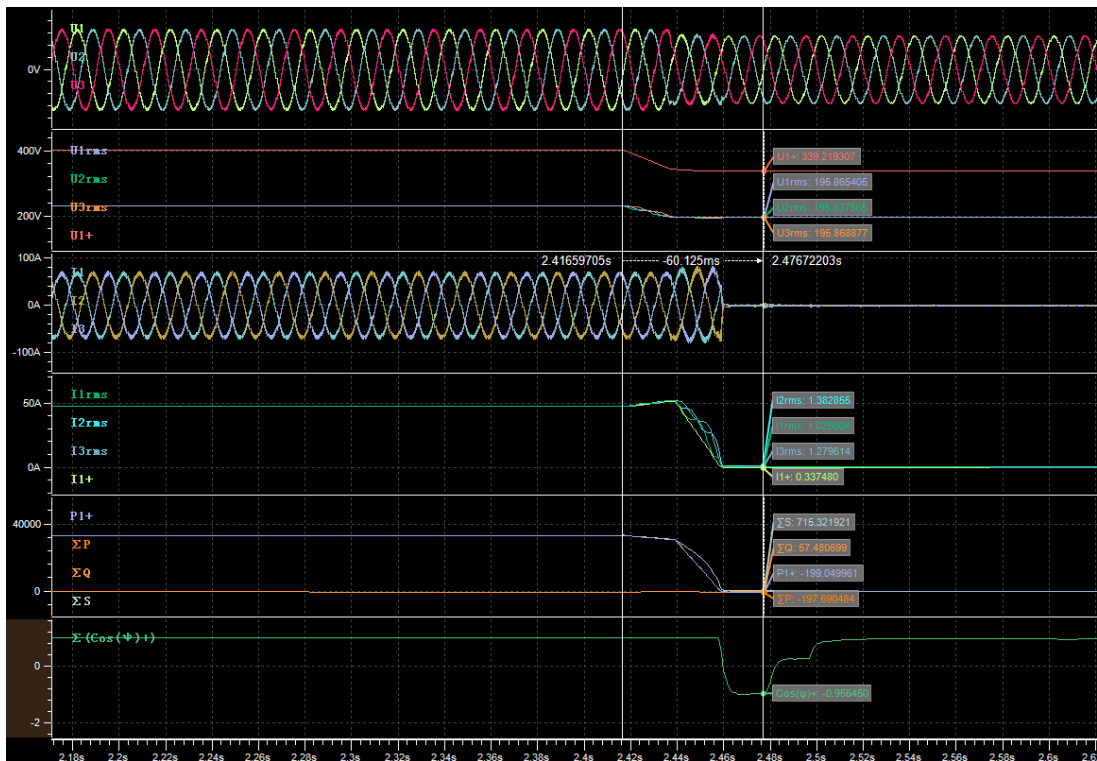

During dip (t1+60ms)



During dip (t1+100ms)

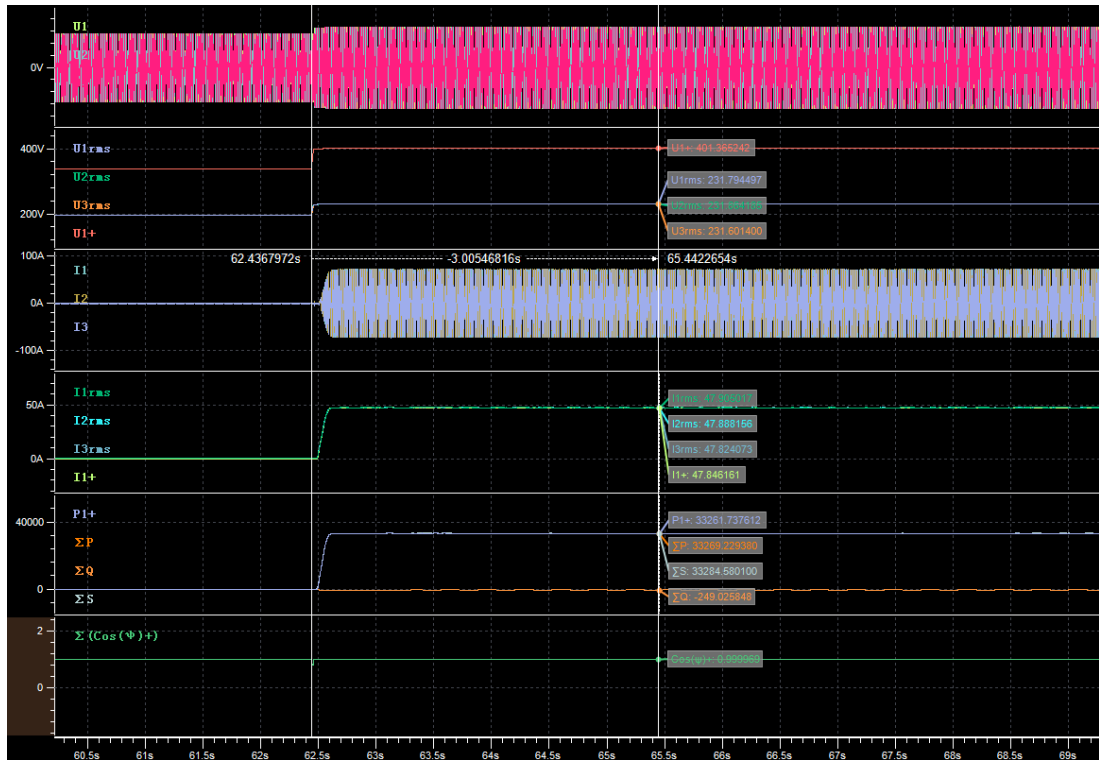

After dip (t2+3s)

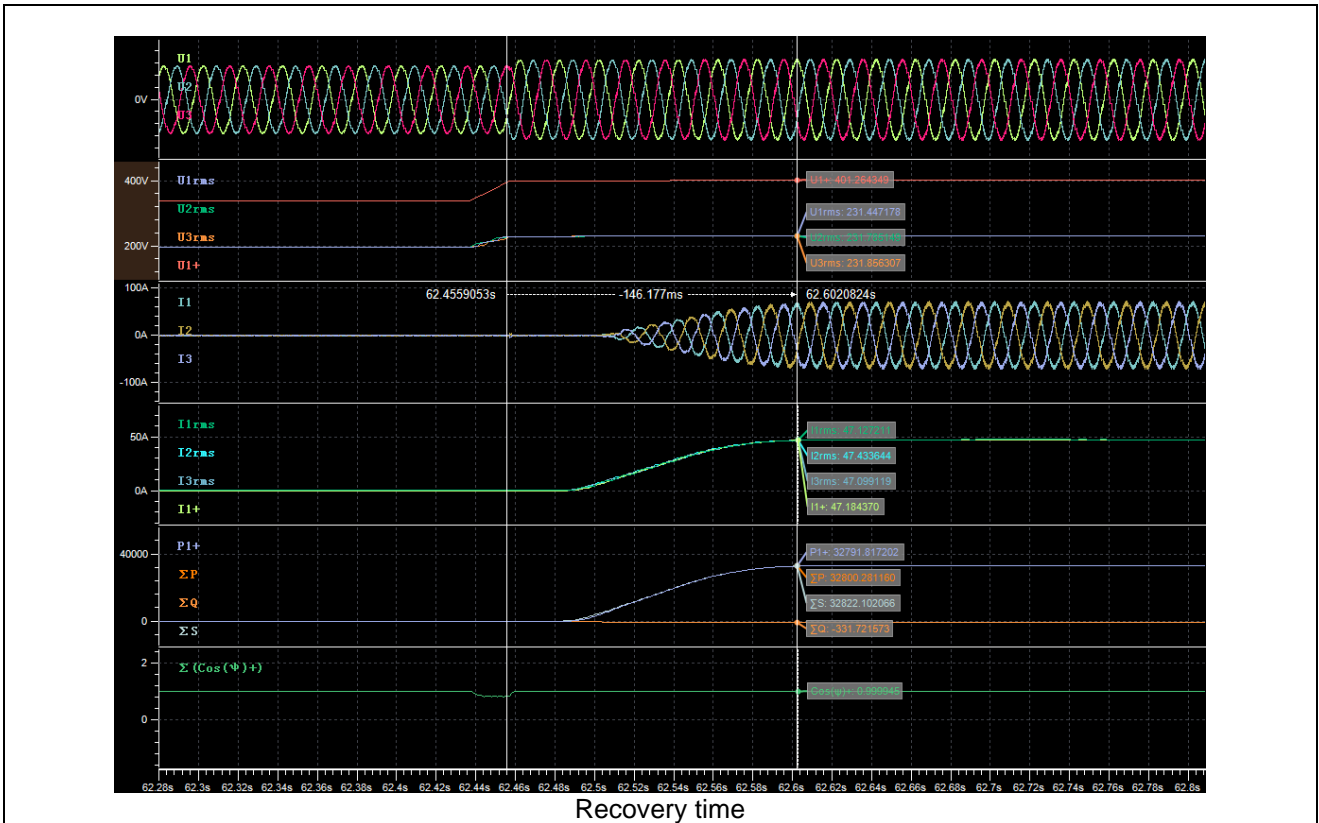

Verification of dynamic network support								P	
Short-circuited power at generator terminal [VA]			60K						
NS protection settings			See table 5.5 for detail.						
	No.	Parameter	Phase ref.	Time ref.	unit	Result			
General Info.	0	Test number	--	--	--	5.1	6.1	7.1	1.2
	1	Date	--	--	dd.mm.yyyy	20-April-2020 to 20-May-2020			
	2	Time (start of test)	--	--	hh:mm:ss.f	See graph			
	3	Fault type (phase)	--	--		A	A	A	A
	4	Setting voltage depth	Line to line	--	p.u.	1.25	1.20	1.15	0.15
	5	Setting dip duration		--	ms	100	5000	60000	150
	6	Point of fault entry	Total	--	ms	20ms			
	7	Point of fault clearance	Total	--	ms	20ms			
	8	Fault duration in empty load test	Total	--	ms	100.70	5007.6	60004	160.67
	9	Voltage depth/height in empty load test	Total	t1+100ms to t2 and t1-10s to t1	p.u.	1.250	1.20	1.15	0.150
10	Positive sequence			p.u.	1.245	1.197	1.145	0.150	
Before dip <t1	11	Voltage	Line to neutral	t1-10s to t1	p.u.	1.00	1.00	1.00	1.00
	12	Current	Positive sequence	t1-500ms to t1-100ms	p.u.	1.00	1.00	1.01	0.20
	13	Active power	Total	t1-10s to t1	p.u.	1.01	1.01	1.01	0.203
	14		Positive sequence			1.01	1.01	1.01	0.203
	15	Reactive power	Total	t1-10s to t1	p.u.	-0.008	-0.007	-0.007	-0.009
	16		Positive sequence			-0.008	-0.007	-0.007	-0.009
	17	Cos $\phi$	--	t1-10s to t1	--	0.9999	0.9999	0.9999	0.9989
During dip t1 to t2	18	Voltage	Line to neutral	t1+100ms to t2-20ms	p.u.	1.25	1.20	1.15	0.15
	19	Line current	Phase 1	t1+60ms	p.u.	0.054	0.058	0.059	0.008

	20		Phase 2			0.049	0.054	0.092	0.008
	21		Phase 3			0.048	0.050	0.074	0.007
	22	Line current	Phase 1	t1+100ms	p.u.	0.053	0.048	0.048	0.007
	23		Phase 2			0.054	0.048	0.046	0.008
	24		Phase 3			0.056	0.050	0.048	0.007
	25	Active power	Total	t1+100ms to t2-20ms	p.u.	0.006	0.008	0.008	0.001
26	Positive sequence		0.006			0.008	0.008	0.001	
After dip > t2	27	Voltage	Line to neutral	t2+3s to t2+10s	p.u.	1.00	1.00	1.00	1.00
	28	Active power	Positive sequence.	t2+3s to t2+10s	p.u.	1.01	1.01	1.01	0.203
	29		Total			1.01	1.01	1.01	0.202
	39	Active power rising time	Positive sequence	--	s	0.194	0.056	0.090	0.063
	31	Reactive power	Positive sequence	t2+3s to t2+10s	p.u.	-0.004	-0.007	-0.011	-0.008
	32		Total			-0.004	-0.007	-0.011	-0.008
	33	Reactive power rising time	Positive sequence	--	s	0.194	0.056	0.090	0.063
	34	PGU does not disconnect from grid till 60s after fault	--	t2 to t2+60s	Yes / No	Yes			

Graph of Test number 5.1

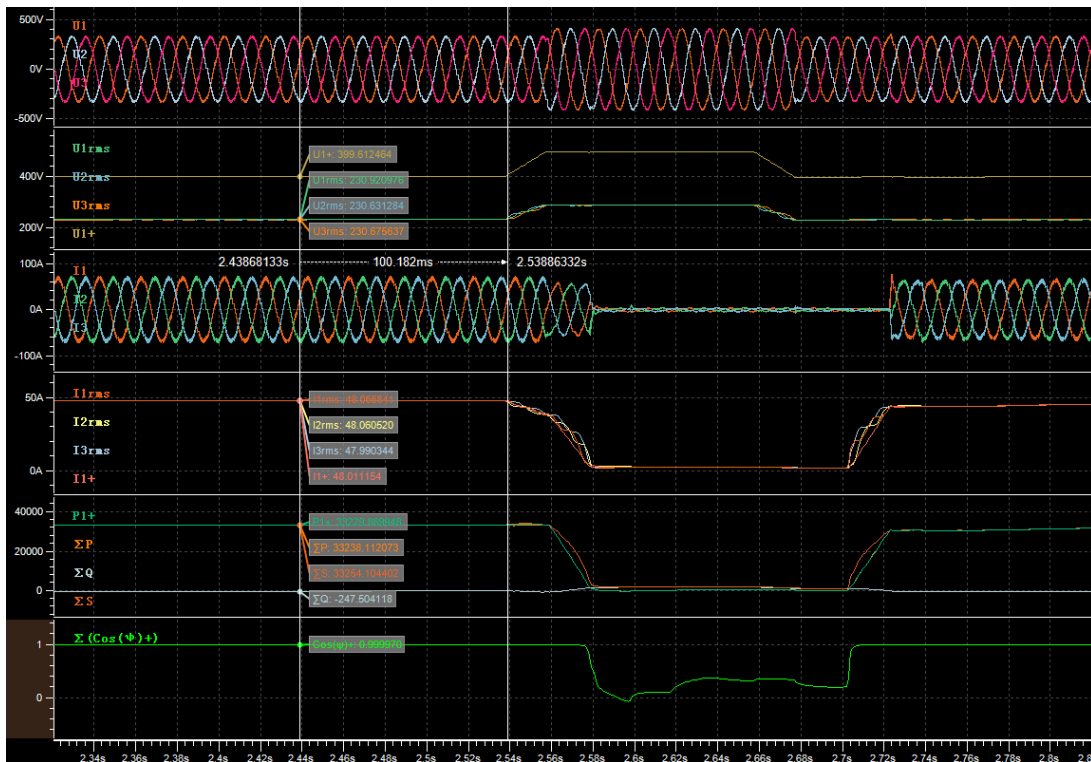
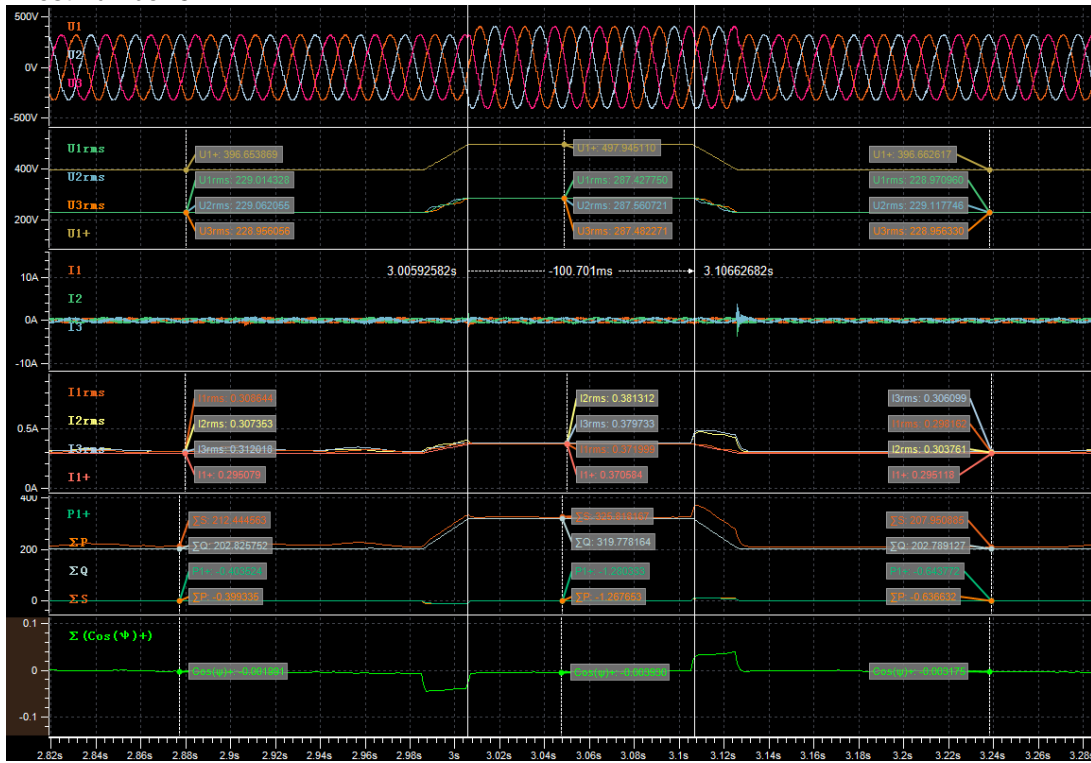

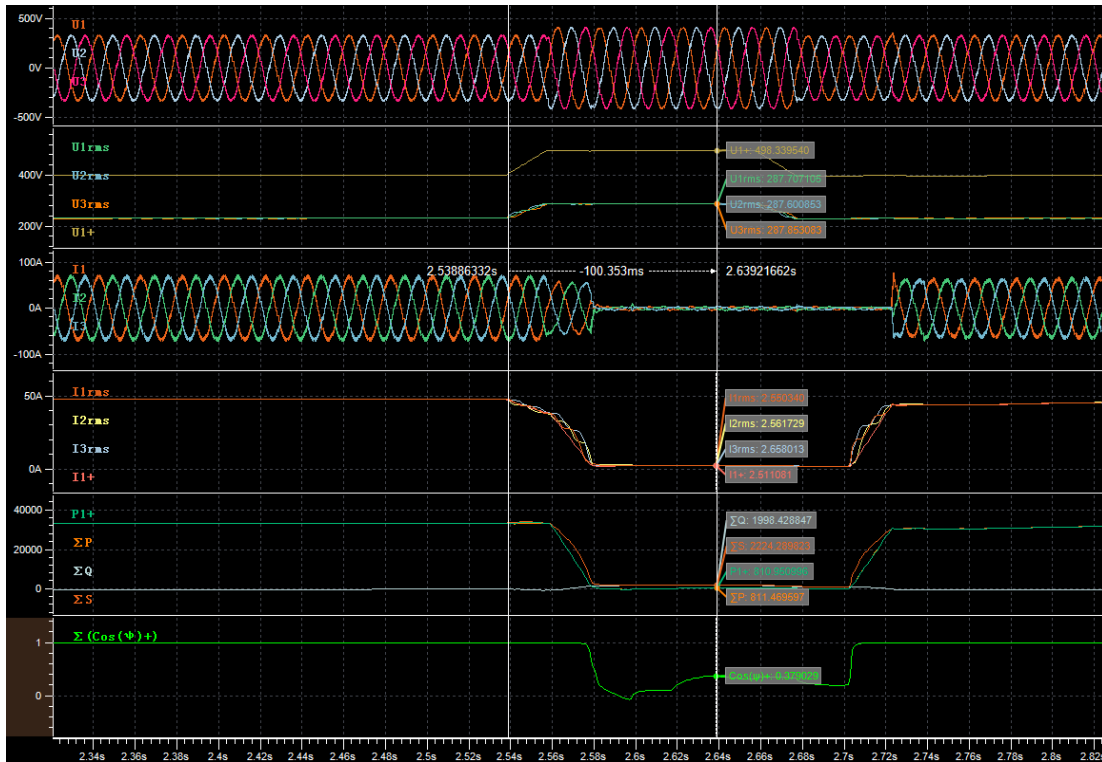
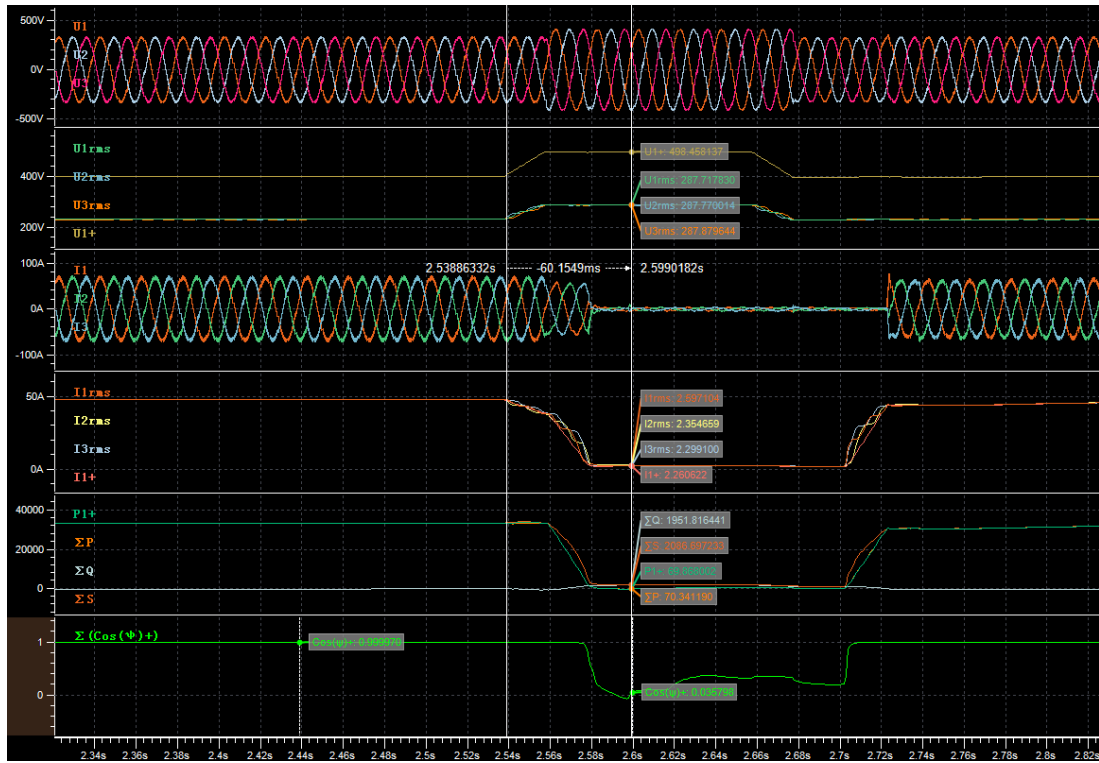

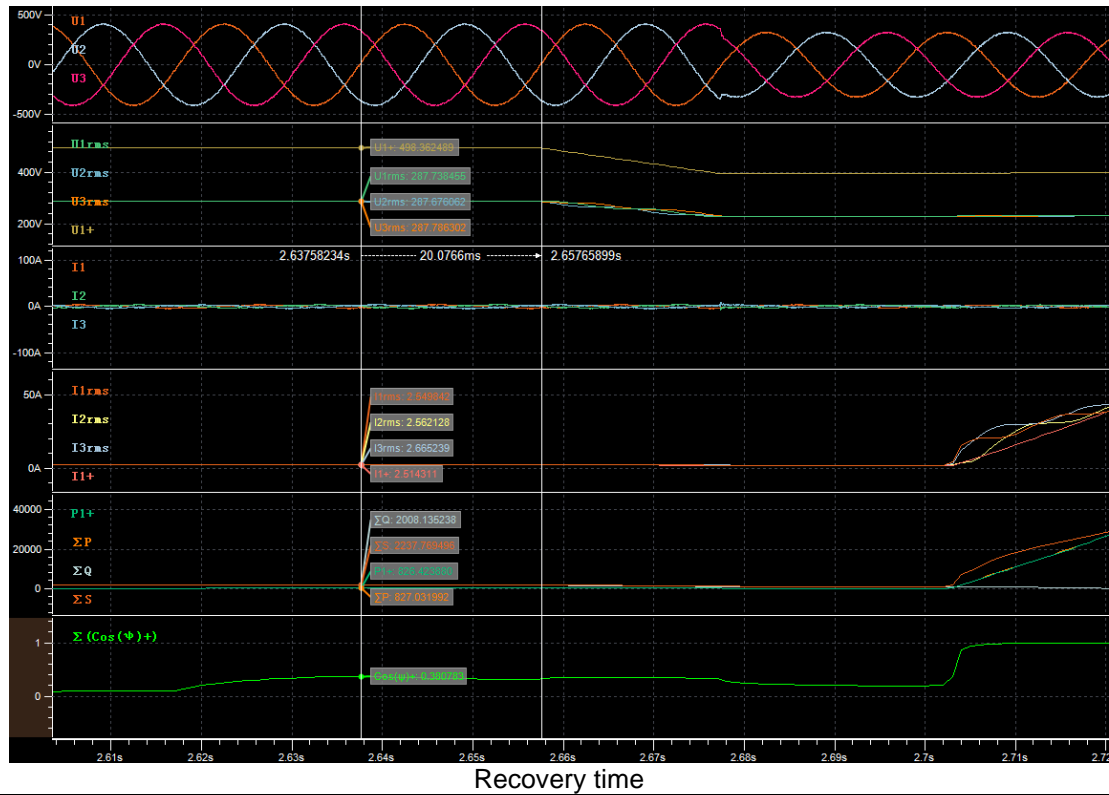
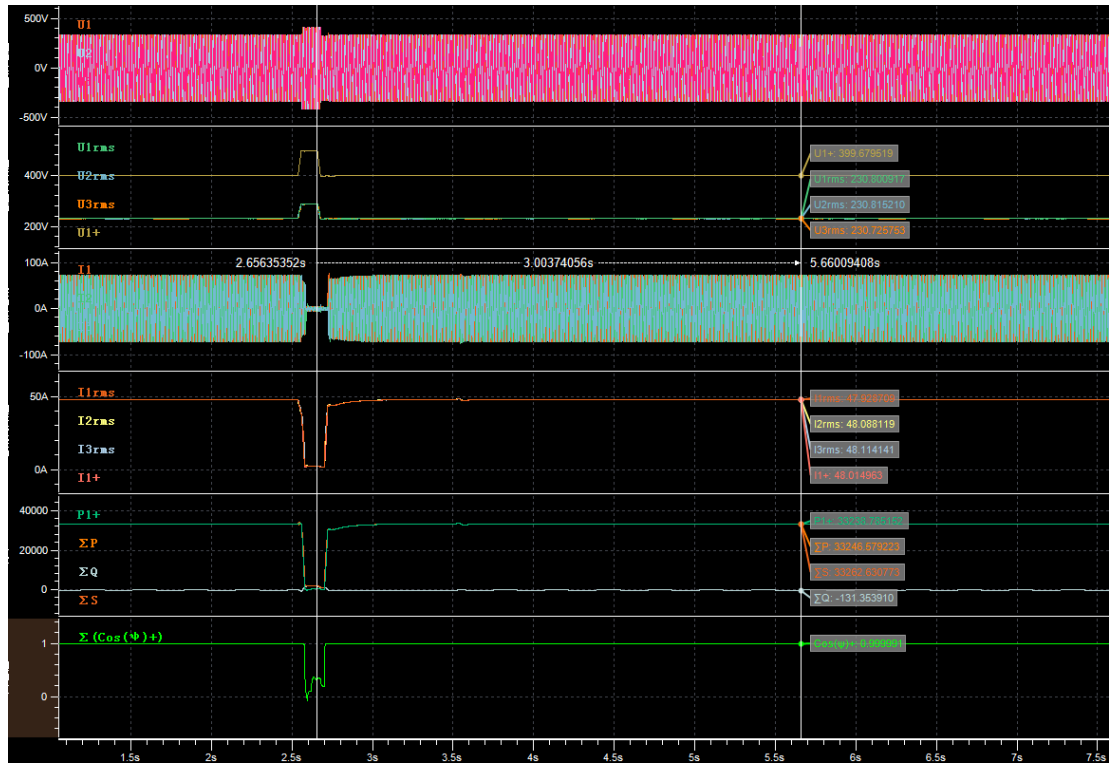



Graph of Test number 6.1

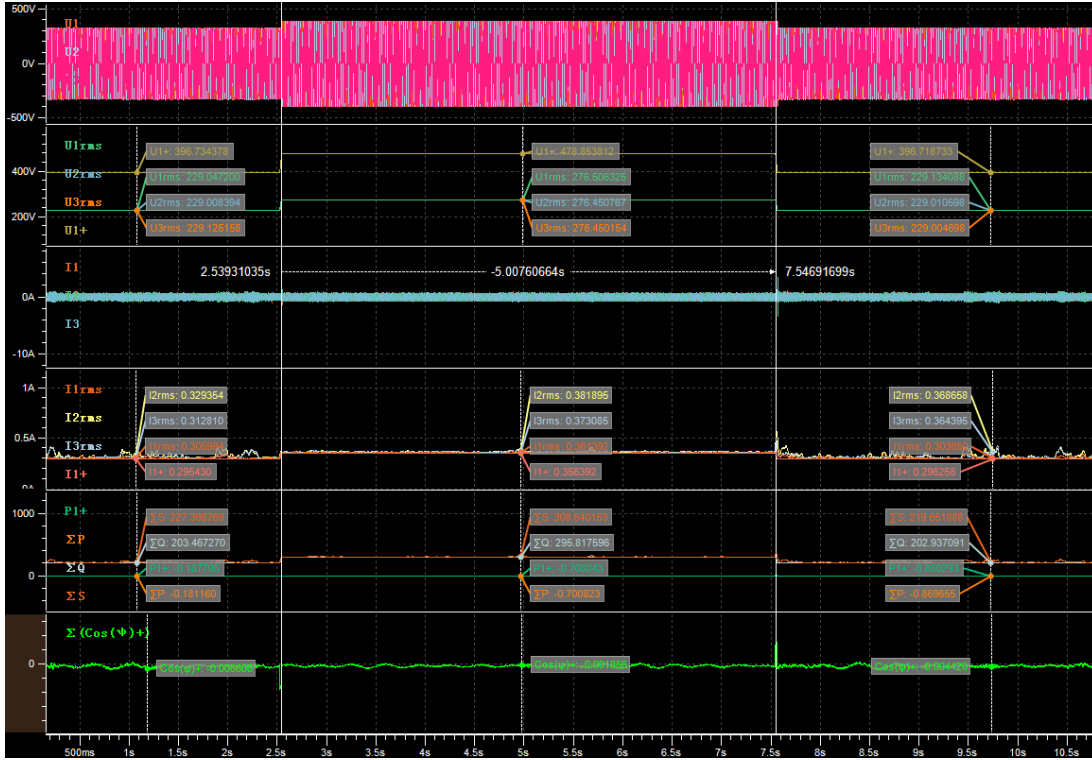

Empty load

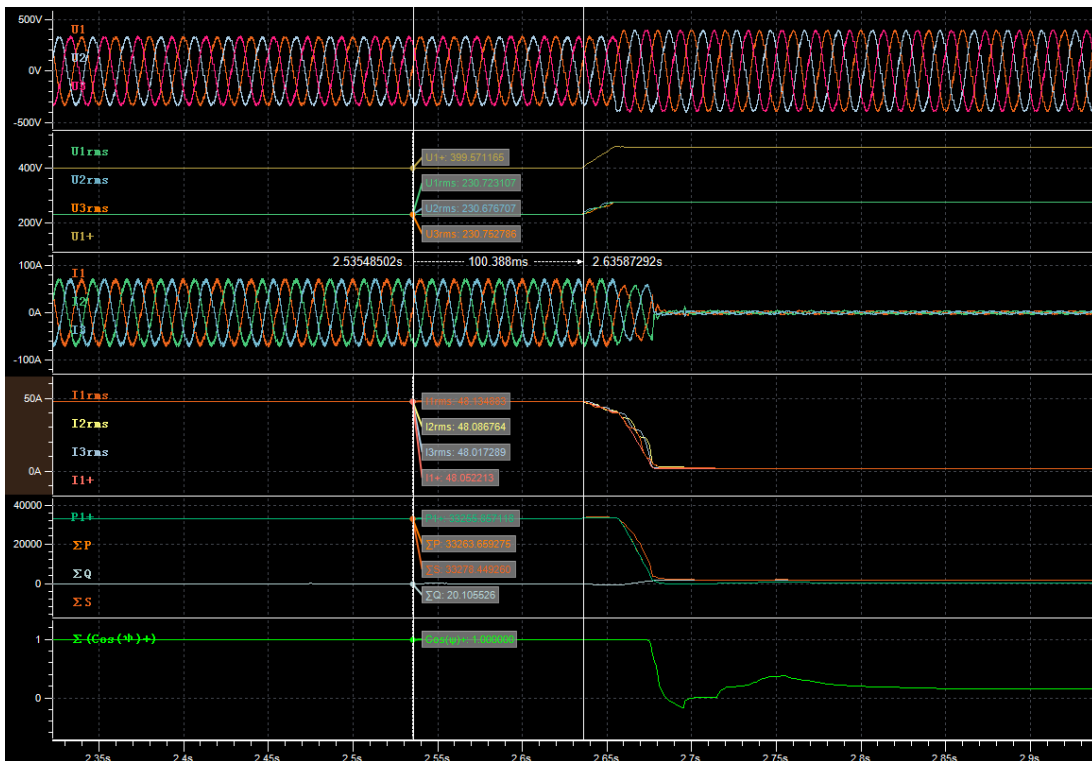

Before dip (t1-100ms)

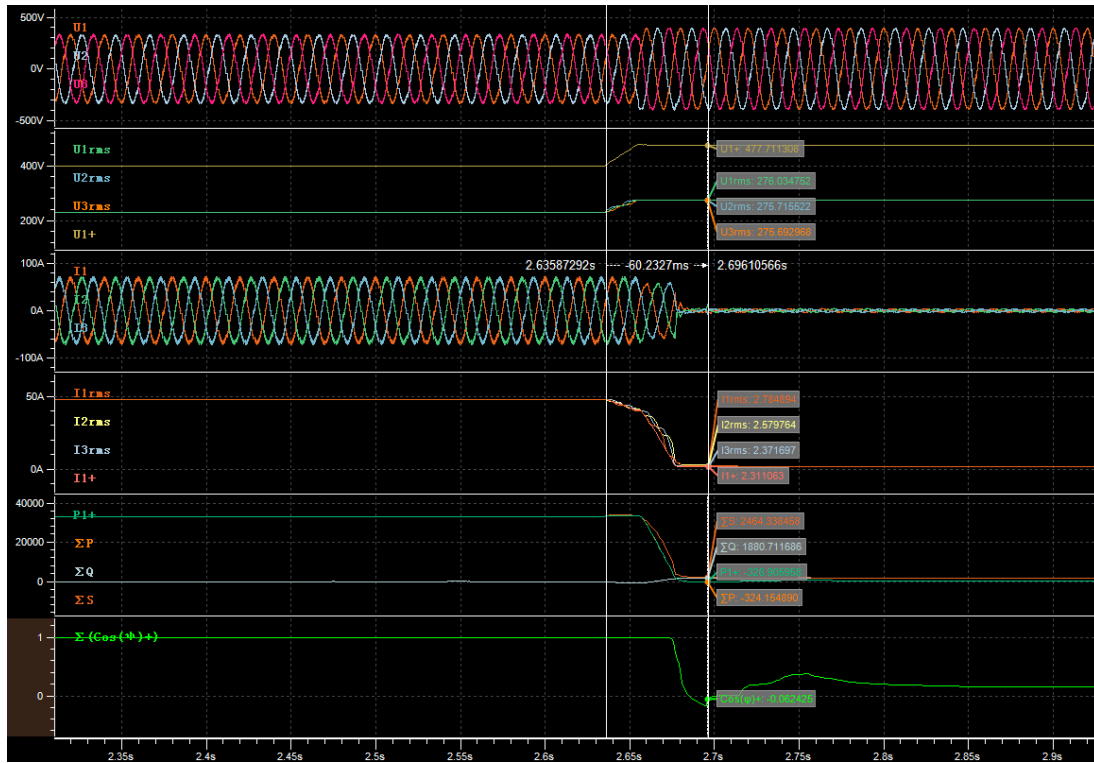

During dip (t1+60ms)

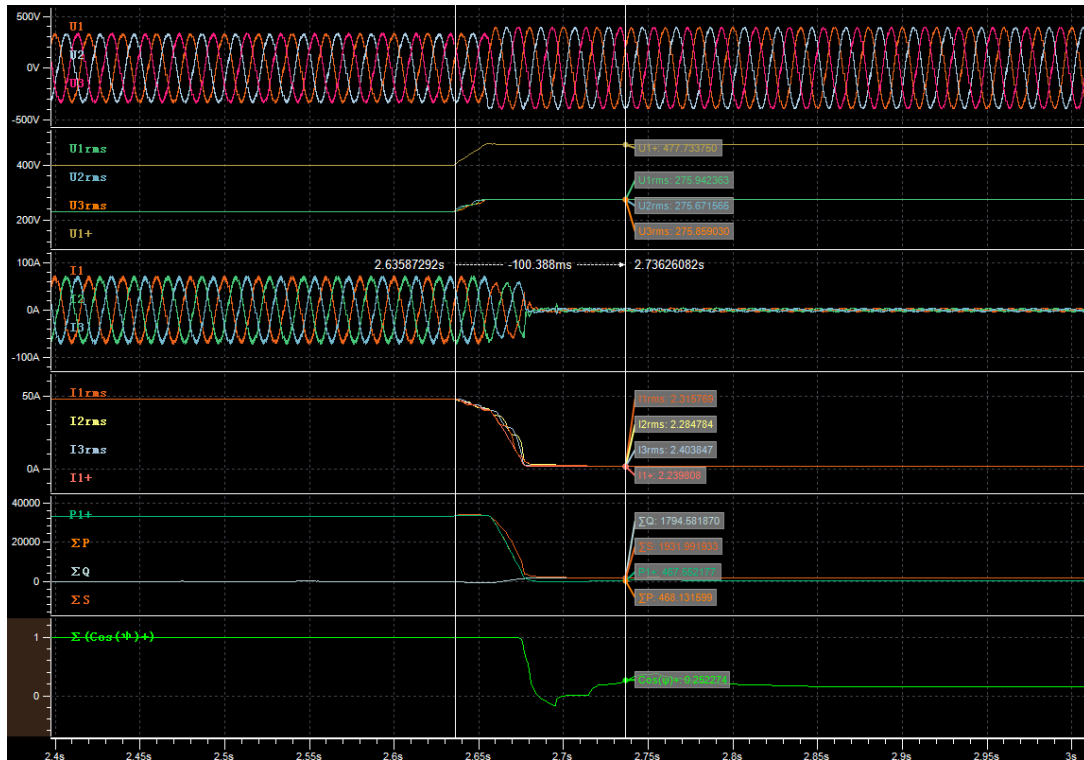

During dip (t1+100ms)

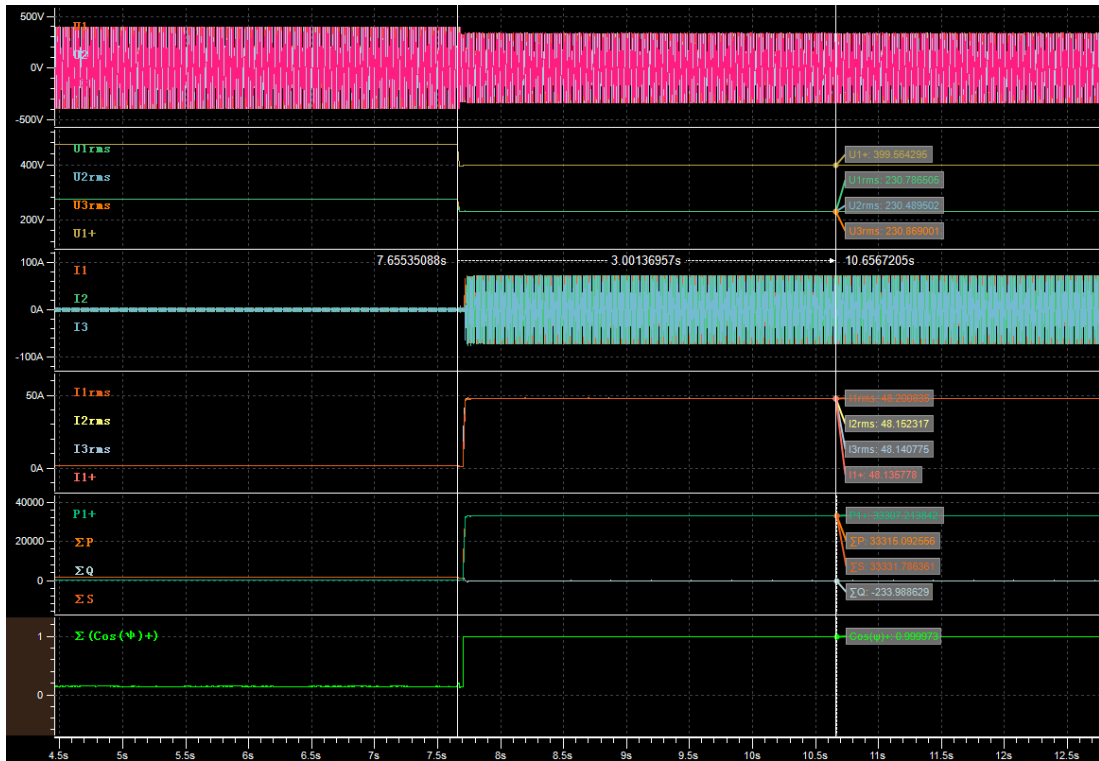

After dip (t2+3s)

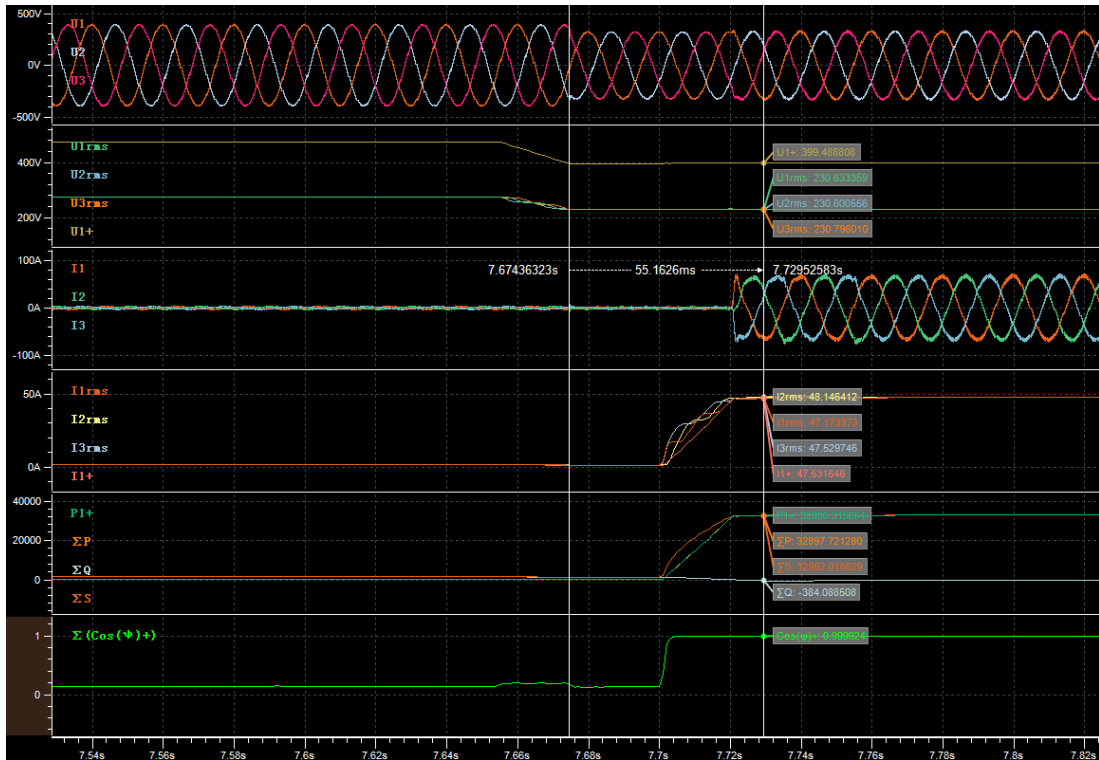

Recovery time

Graph of Test number 7.1

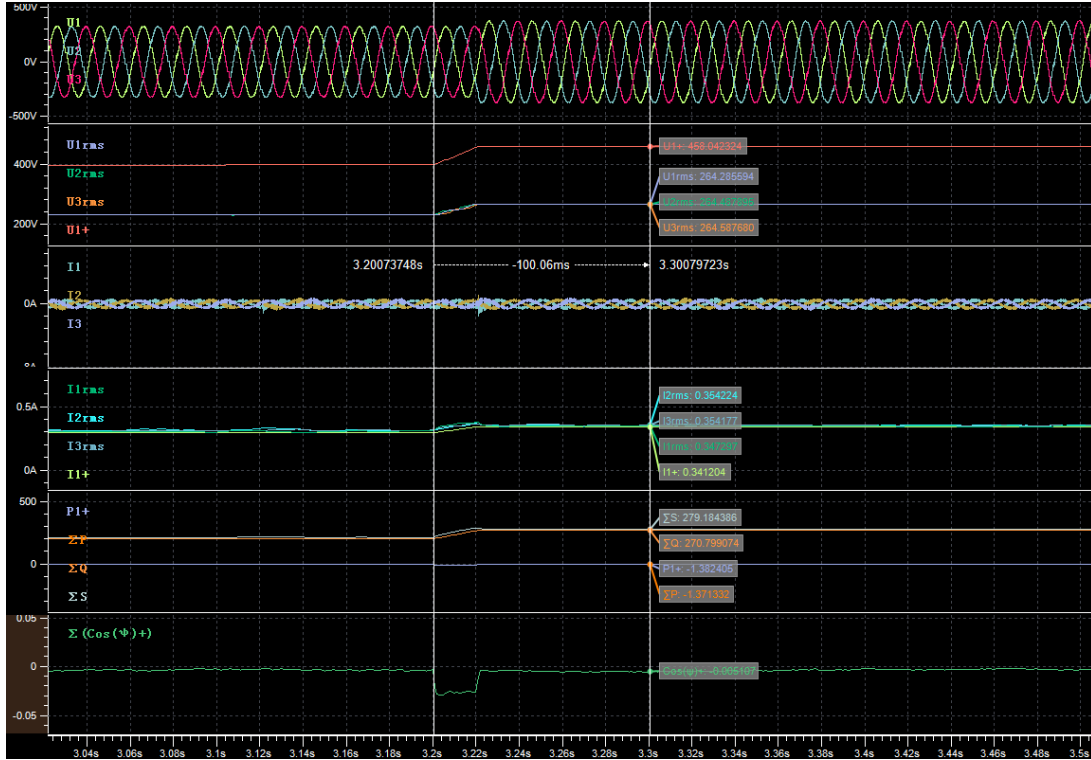

Empty load

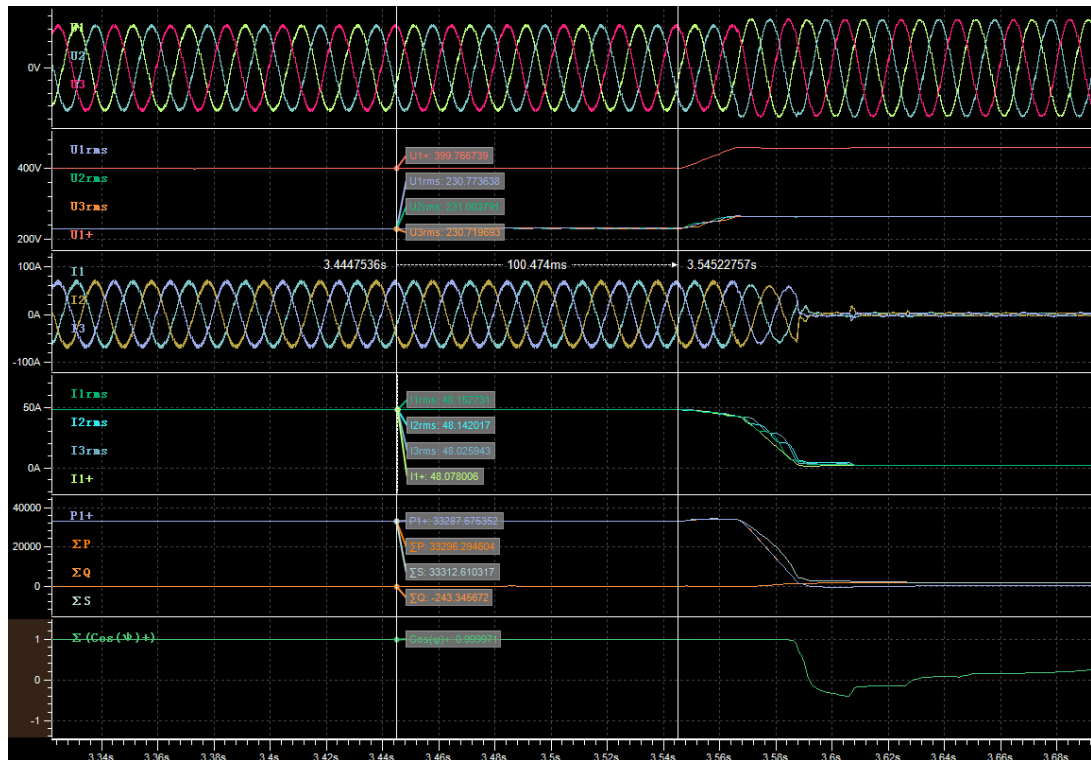

Before dip (t1-100ms)

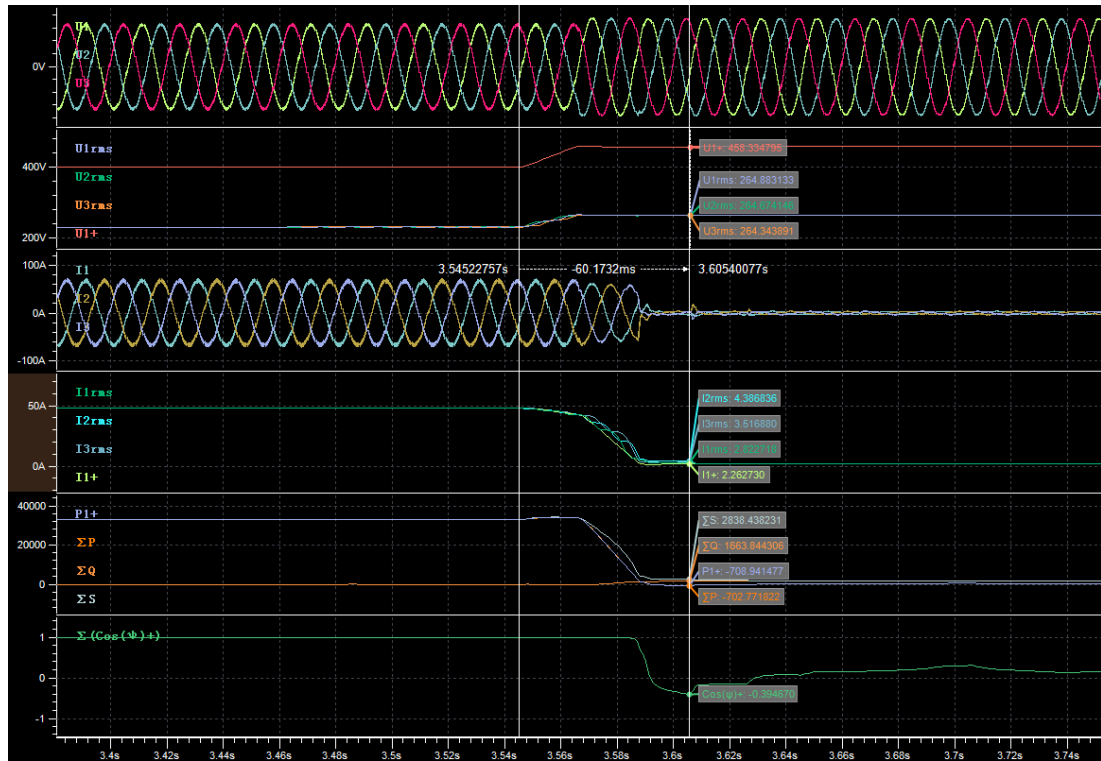

During dip (t1+60ms)

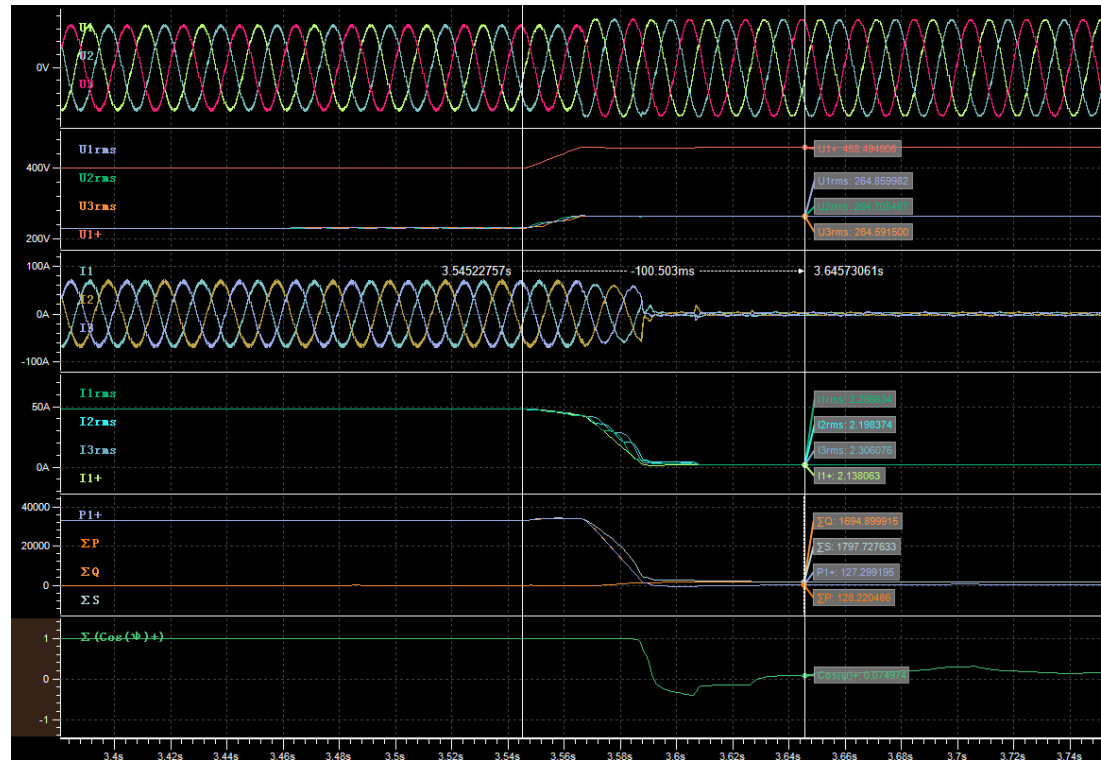

During dip (t1+100ms)

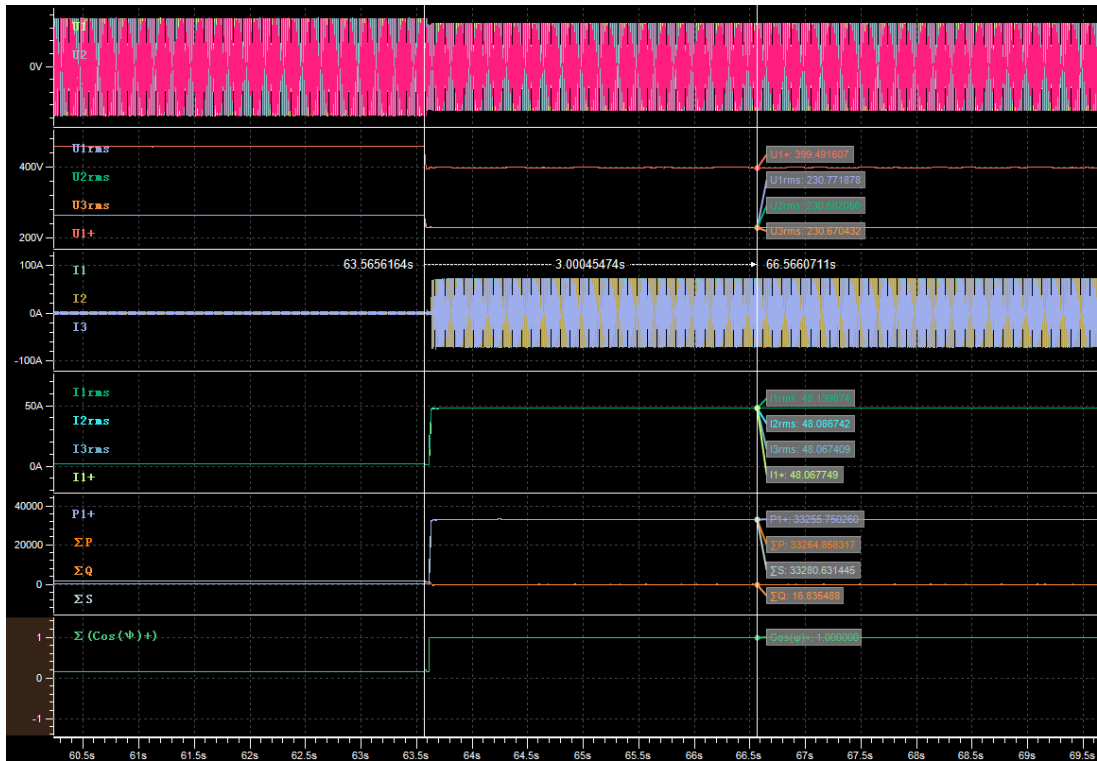

After dip (t2+3s)

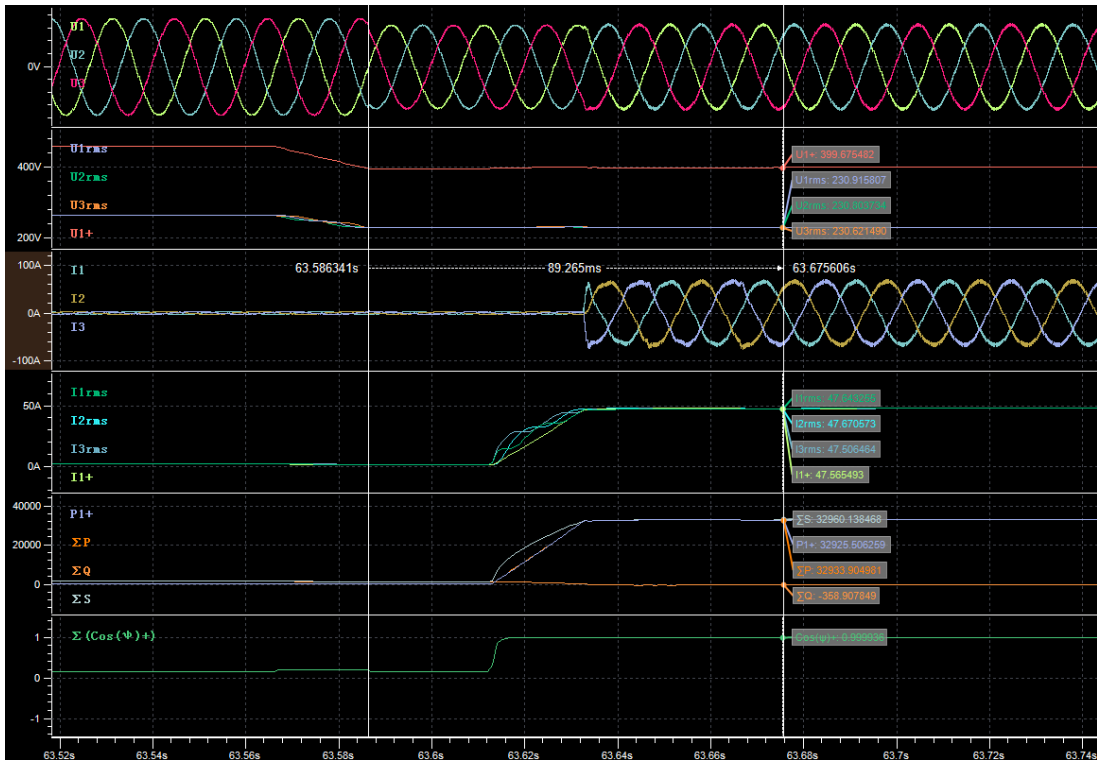

Recovery time

Graph of Test number 1.2

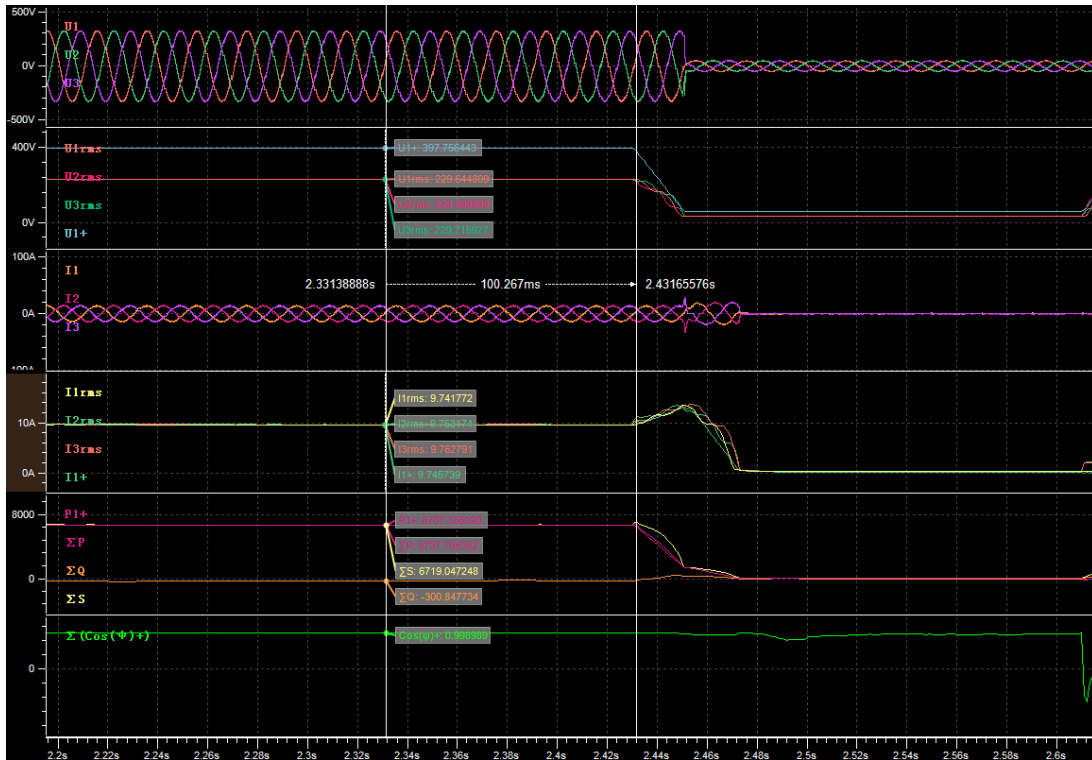

Before dip (t1-100ms)

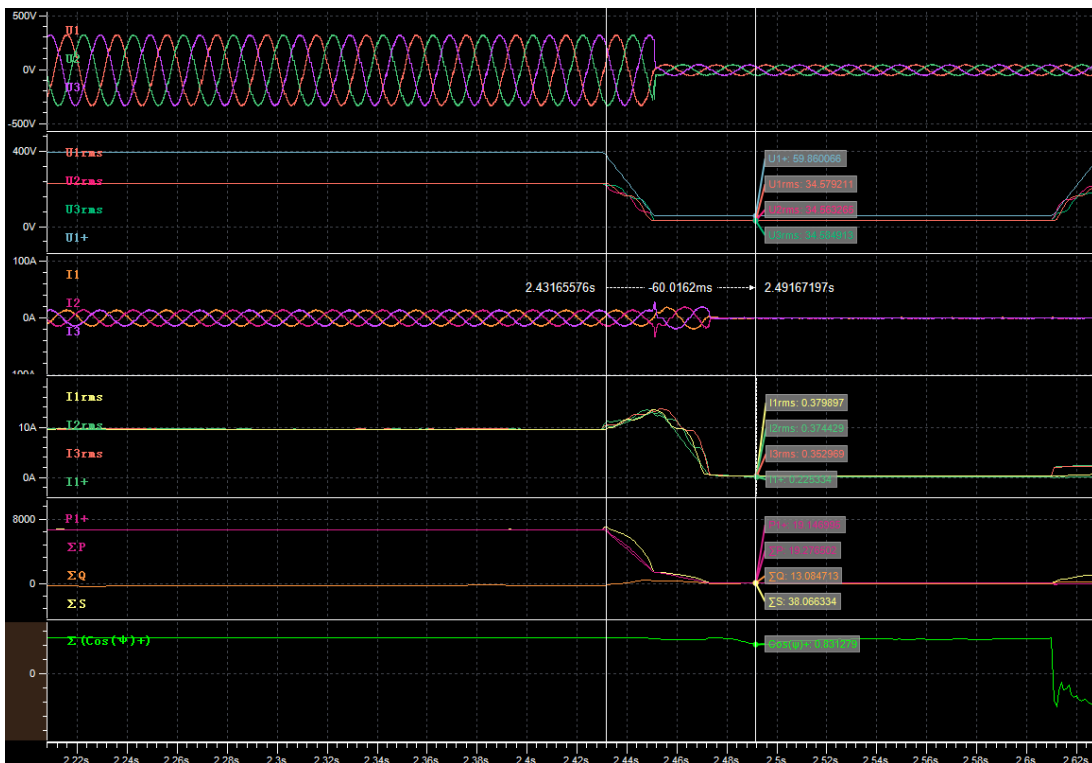

During dip (t1+60ms)

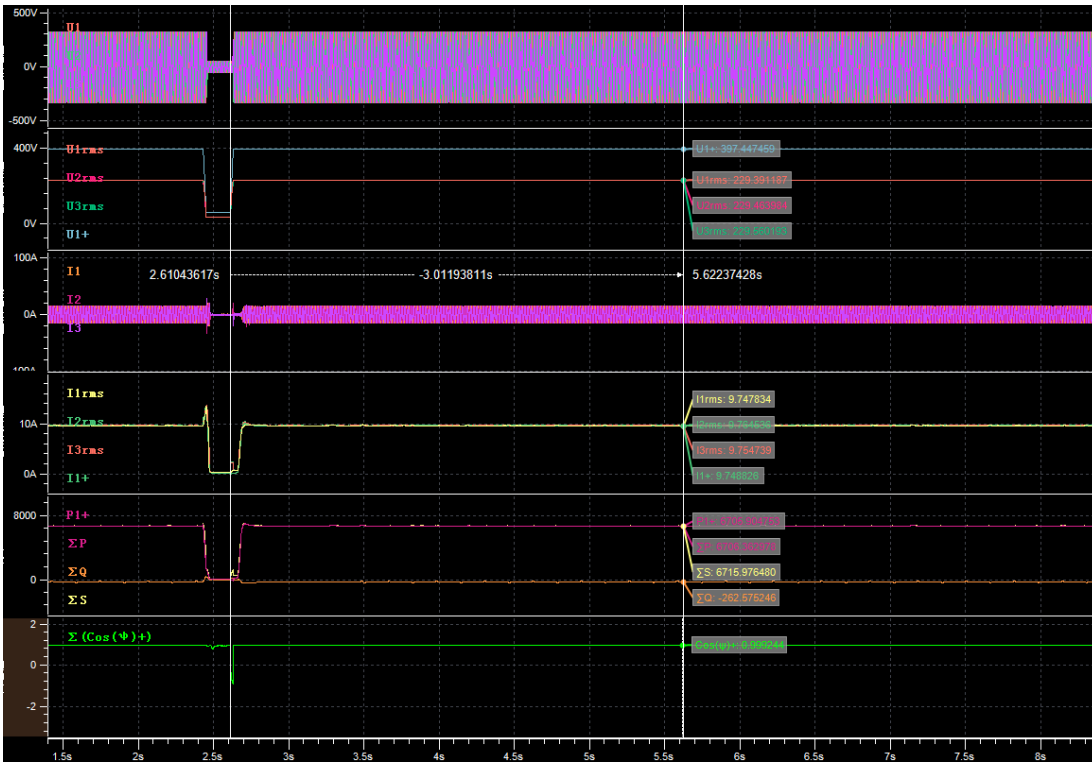
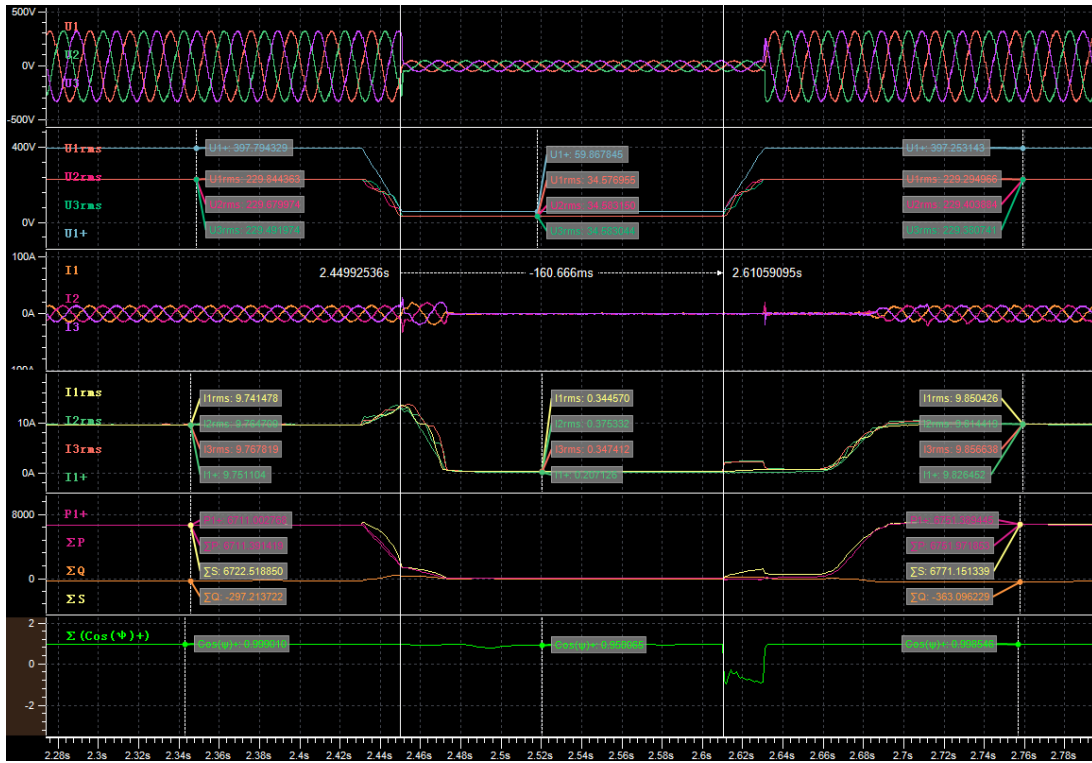



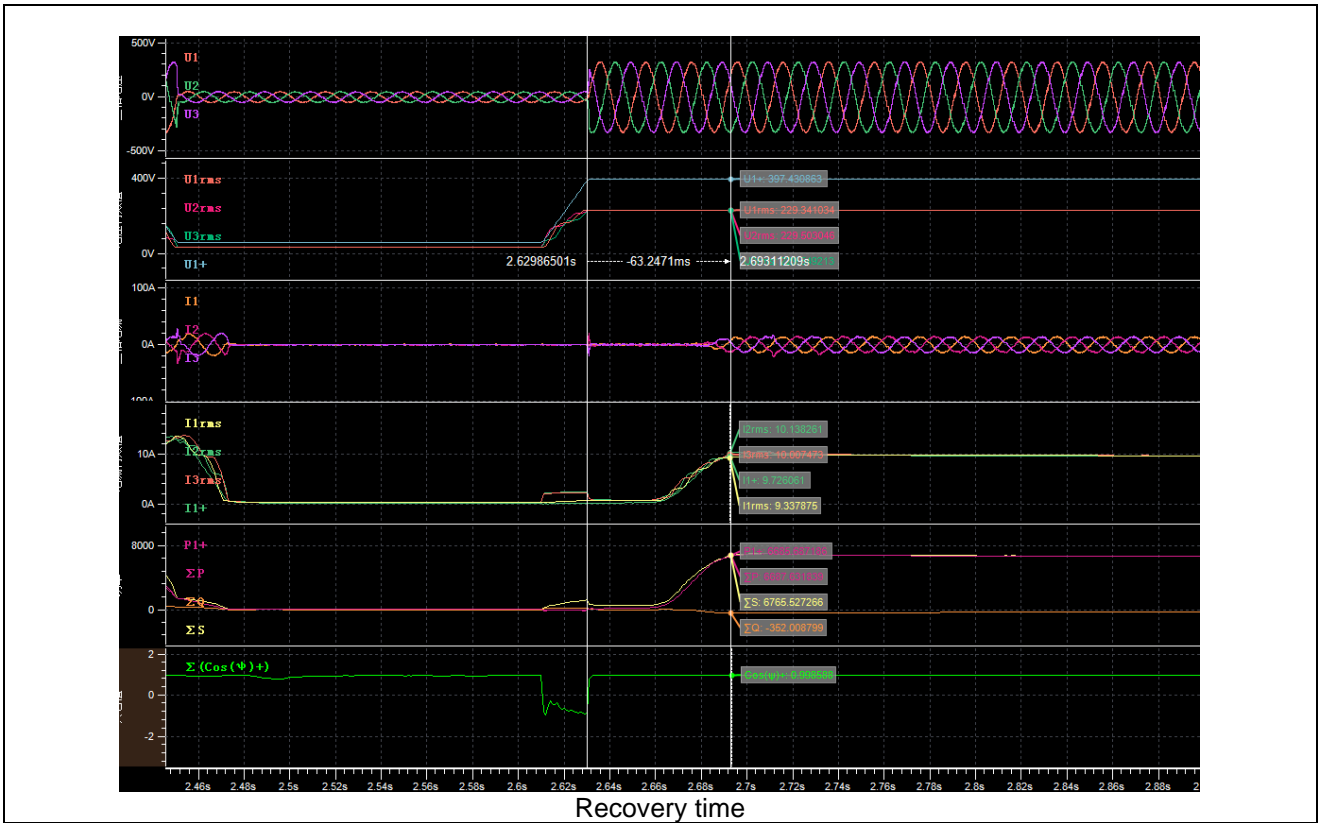

Verification of dynamic network support								P	
Short-circuited power at generator terminal [VA]			60K						
NS protection settings			See table 5.5 for detail.						
	No.	Parameter	Phase ref.	Time ref.	unit	Result			
General Info.	0	Test number	--	--	--	2.2	3.2	4.2	5.2
	1	Date	--	--	dd.mm.yyyy	20-April-2020 to 20-May-2020			
	2	Time (start of test)	--	--	hh:mm:ss.f	See graph			
	3	Fault type (phase)	--	--		A	A	A	A
	4	Setting voltage depth	Line to line	--	p.u.	0.5	0.5	0.85	1.25
	5	Setting dip duration		--	ms	1500	1500	60000	100
	6	Point of fault entry	Total	--	ms	20ms			
	7	Point of fault clearance	Total	--	ms	20ms			
	8	Fault duration in empty load test	Total	--	ms	1502.3	1503.7	60010	100.70
	9	Voltage depth/height in empty load test	Total	t1+100ms to t2 and t1-10s to t1	p.u.	0.501	0.501	0.852	1.250
10	Positive sequence		p.u.		0.499	0.499	0.848	1.245	
Before dip <t1	11	Voltage	Line to neutral	t1-10s to t1	p.u.	1.00	1.00	1.00	1.00
	12	Current	Positive sequence	t1-500ms to t1-100ms	p.u.	0.52	0.53	0.21	0.20
	13	Active power	Total	t1-10s to t1	p.u.	0.206	0.205	0.206	0.203
	14		Positive sequence			0.206	0.204	0.206	0.203
	15	Reactive power	Total	t1-10s to t1	p.u.	0.479	-0.484	-0.008	-0.008
	16		Positive sequence			0.479	-0.484	-0.008	-0.008
	17	Cos $\phi$	--	t1-10s to t1	--	0.3948	0.3892	0.9992	0.9992
During dip t1 to	18	Voltage	Line to neutral	t1+100ms to t2-20ms	p.u.	0.50	0.50	0.851	1.250

t2	19	Line current	Phase 1	t1+60ms	p.u.	0.015	0.015	0.021	0.052
	20		Phase 2			0.019	0.019	0.032	0.051
	21		Phase 3			0.015	0.016	0.026	0.047
	22	Line current	Phase 1	t1+100ms	p.u.	0.012	0.013	0.013	0.048
	23		Phase 2			0.013	0.014	0.015	0.047
	24		Phase 3			0.011	0.013	0.014	0.049
	25	Active power	Total	t1+100ms to t2-20ms	p.u.	0.001	0.001	0.002	0.004
26	Positive sequence		0.001			0.001	0.002	0.004	
After dip > t2	27	Voltage	Line to neutral	t2+3s to t2+10s	p.u.	1.00	1.00	1.00	1.00
	28	Active power	Positive sequence.	t2+3s to t2+10s	p.u.	0.206	0.205	0.206	0.203
	29		Total			0.206	0.205	0.206	0.203
	39	Active power rising time	Positive sequence	--	s	0.059	0.063	0.062	0.059
	31	Reactive power	Positive sequence	t2+3s to t2+10s	p.u.	0.480	-0.484	-0.008	-0.008
	32		Total			0.480	-0.484	-0.008	-0.008
	33	Reactive power rising time	Positive sequence	--	s	0.059	0.063	0.062	0.059
	34	PGU does not disconnect from grid till 60s after fault	--	t2 to t2+60s	Yes / No	Yes			

Graph of Test number 2.2

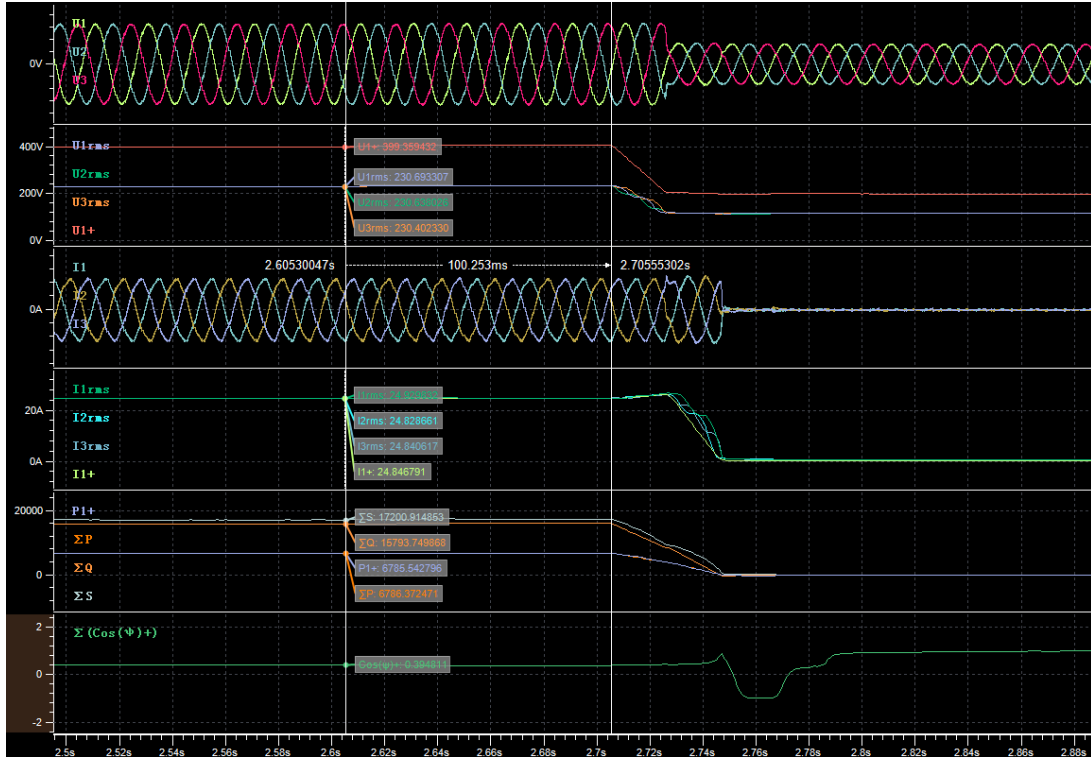

Before dip (t1-100ms)

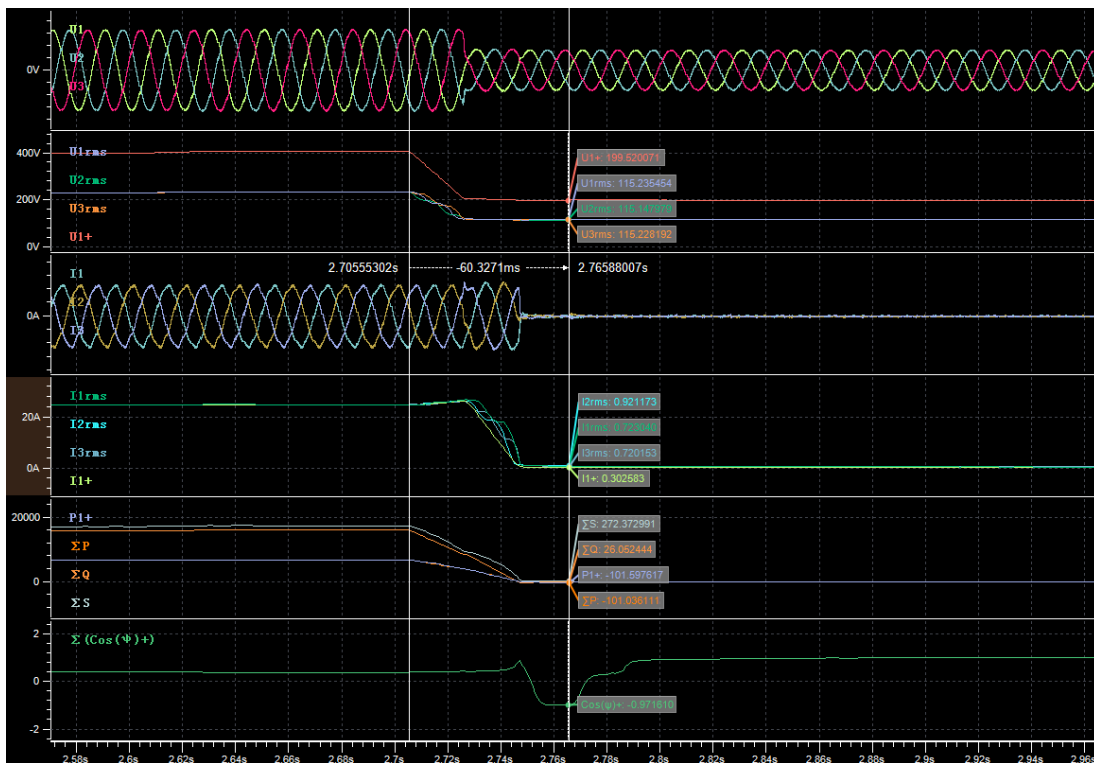

During dip (t1+60ms)

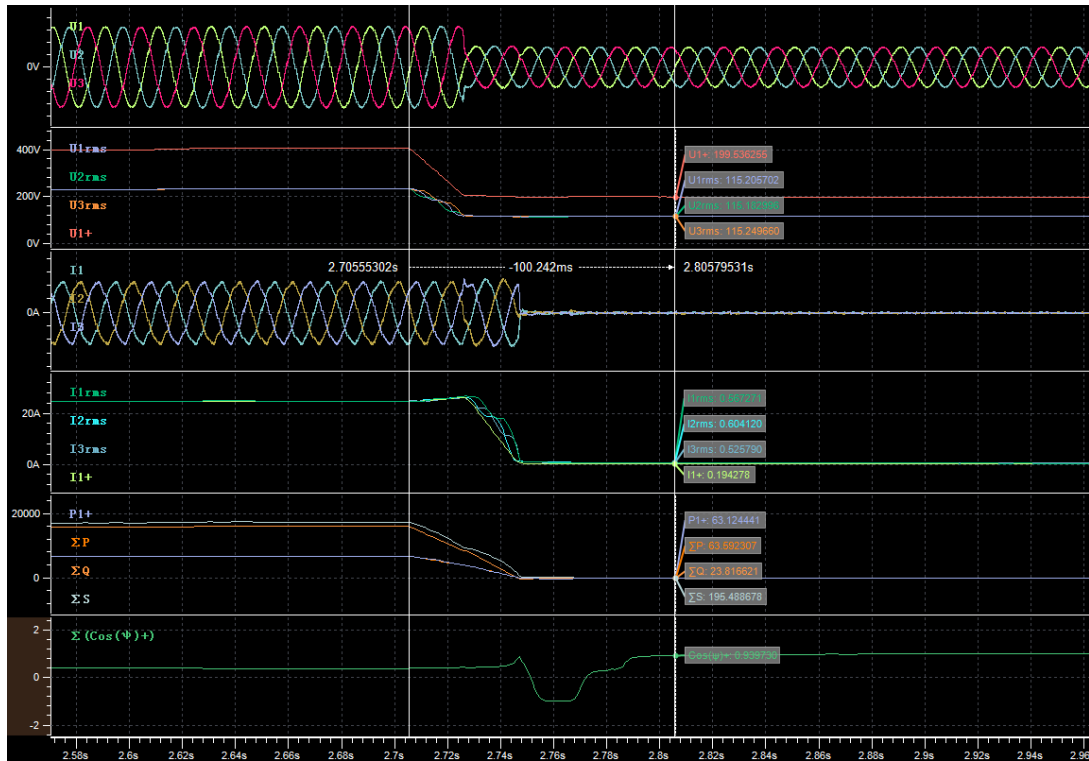

During dip (t1+100ms)

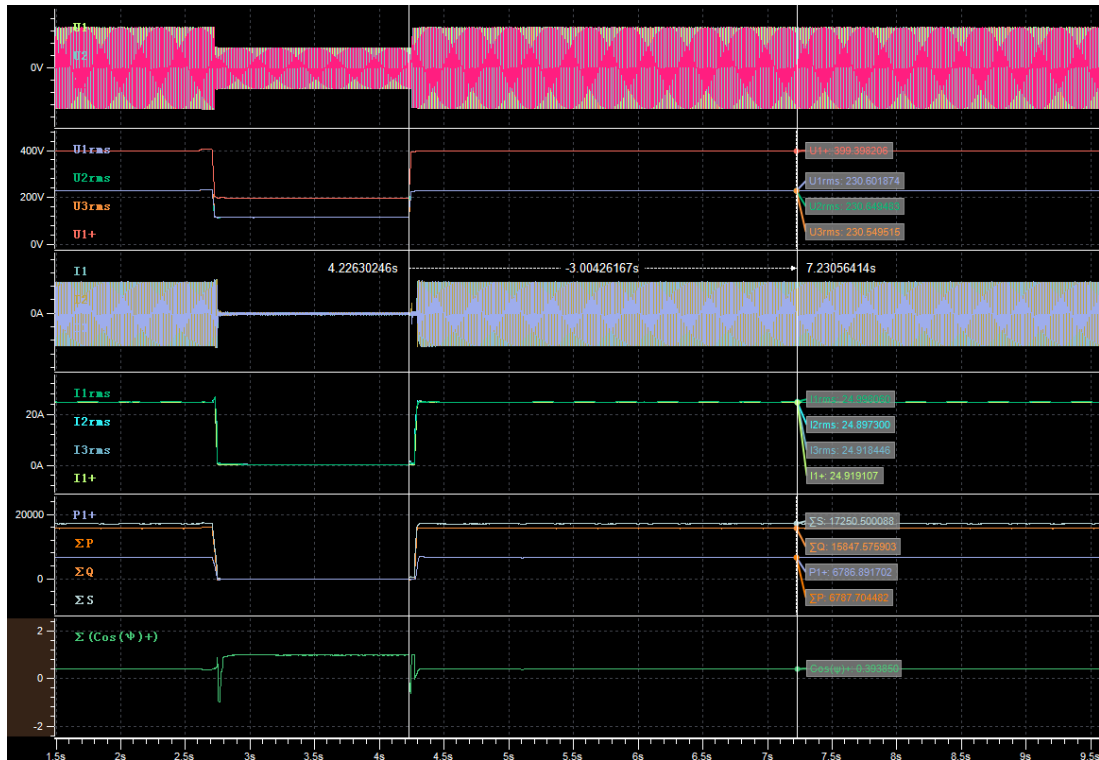

After dip (t2+3s)

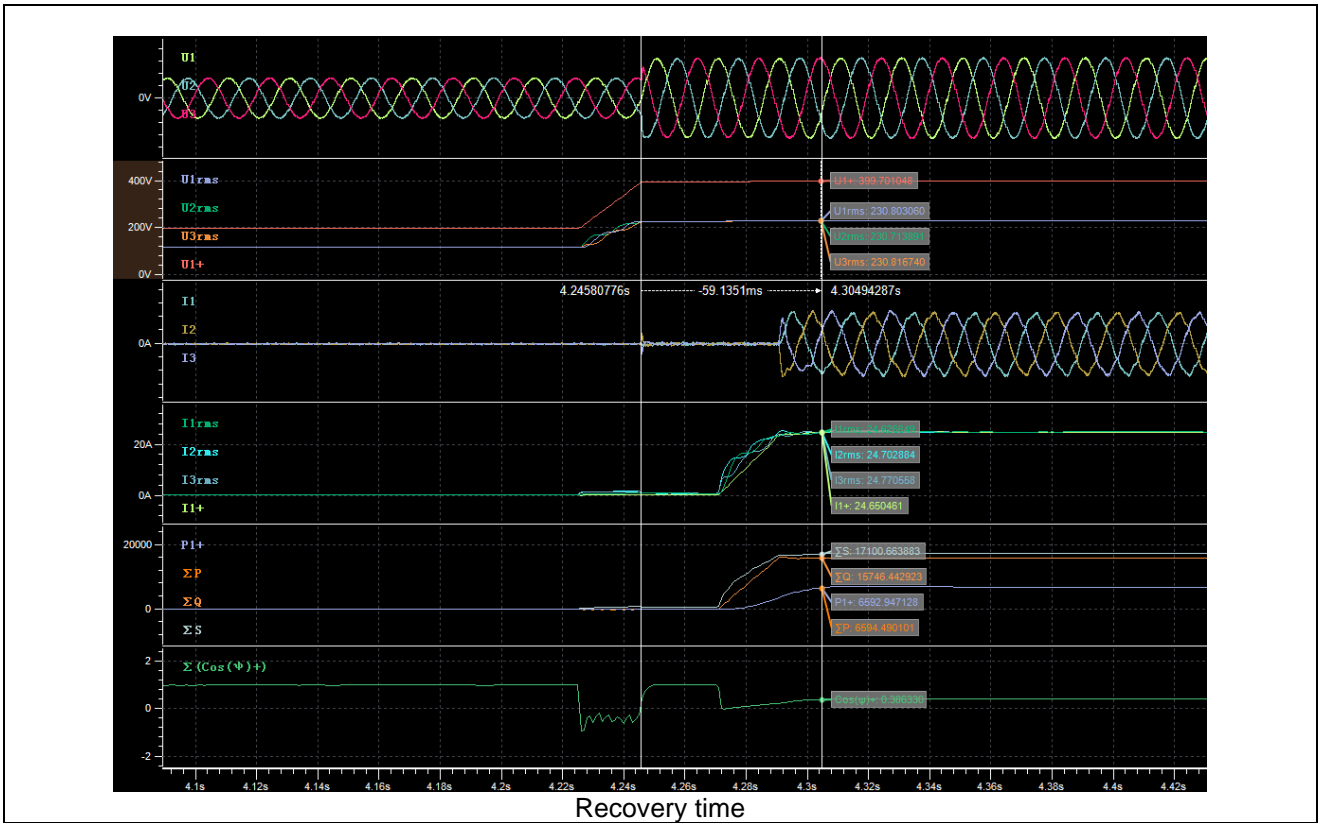

Graph of Test number 3.2

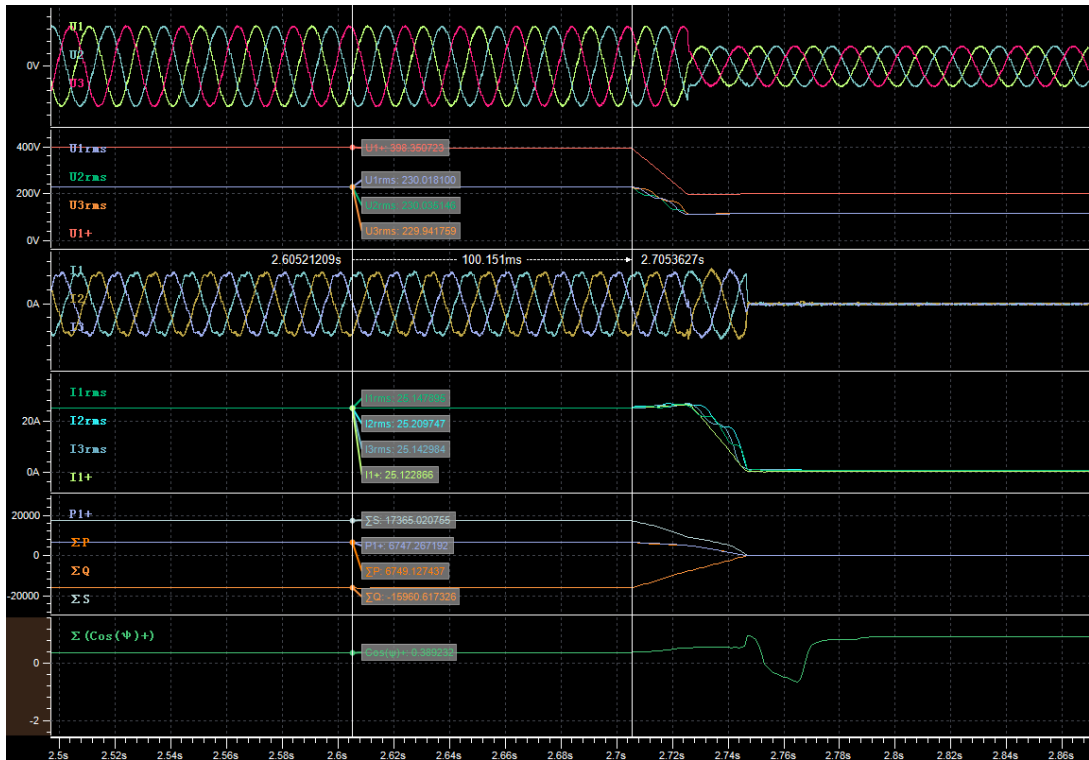

Before dip (t1-100ms)

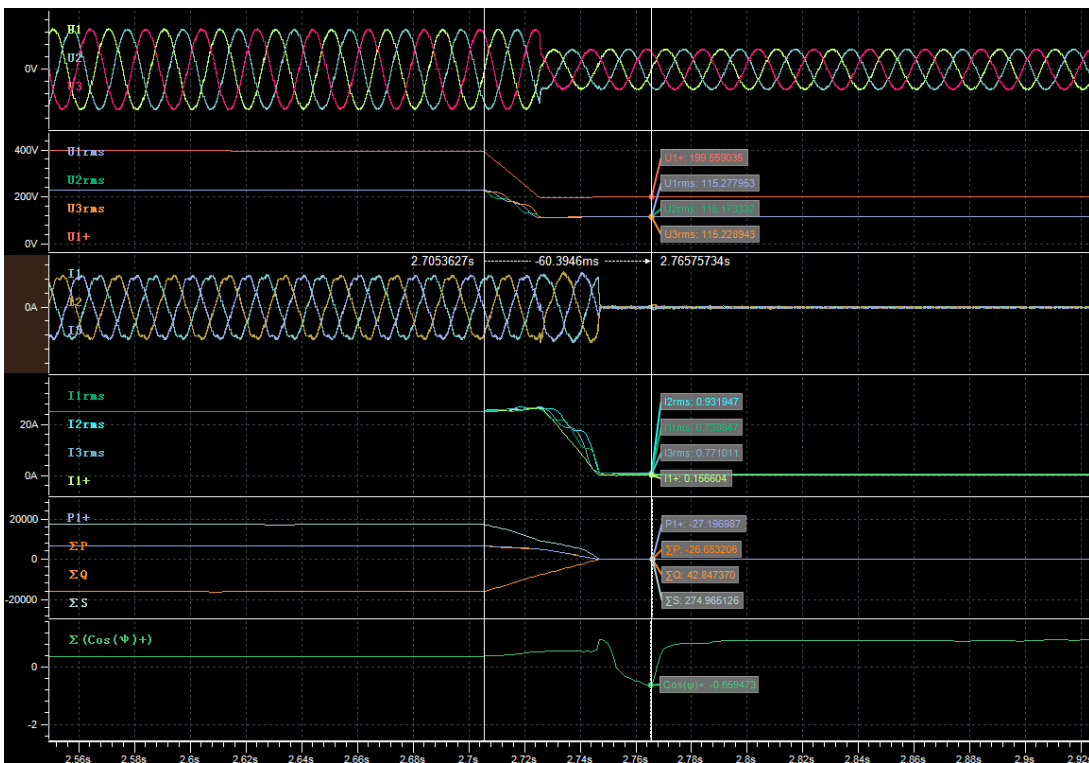

During dip (t1+60ms)

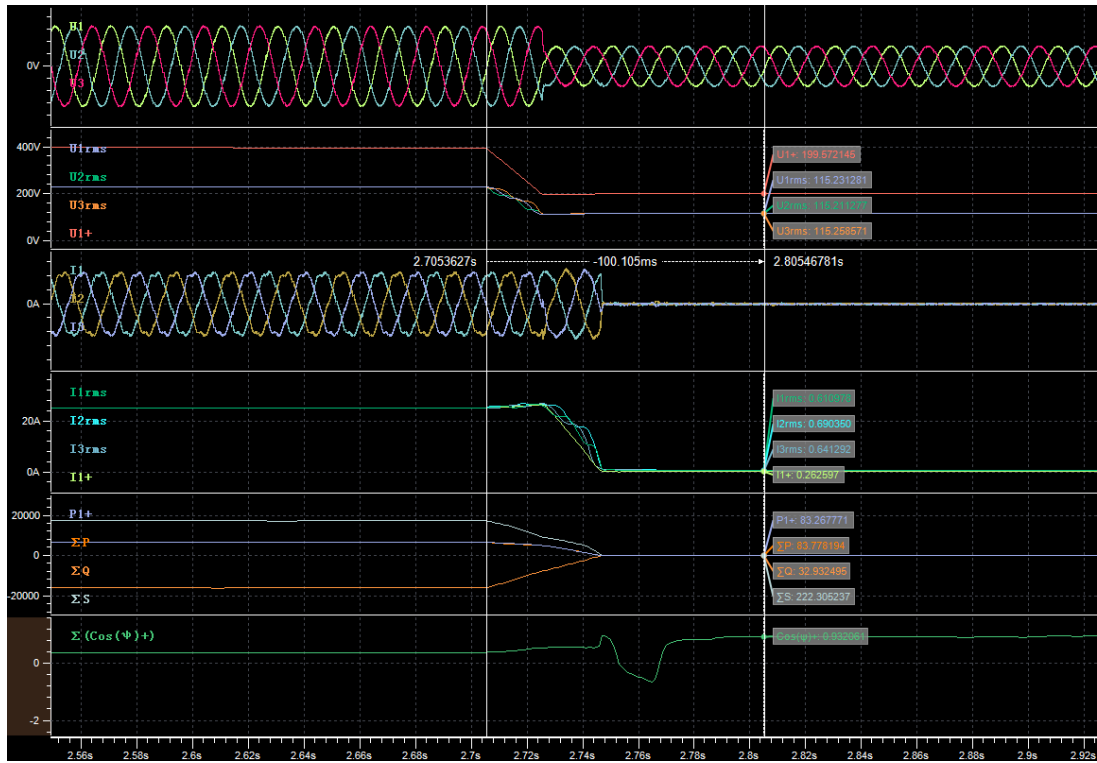

During dip (t1+100ms)

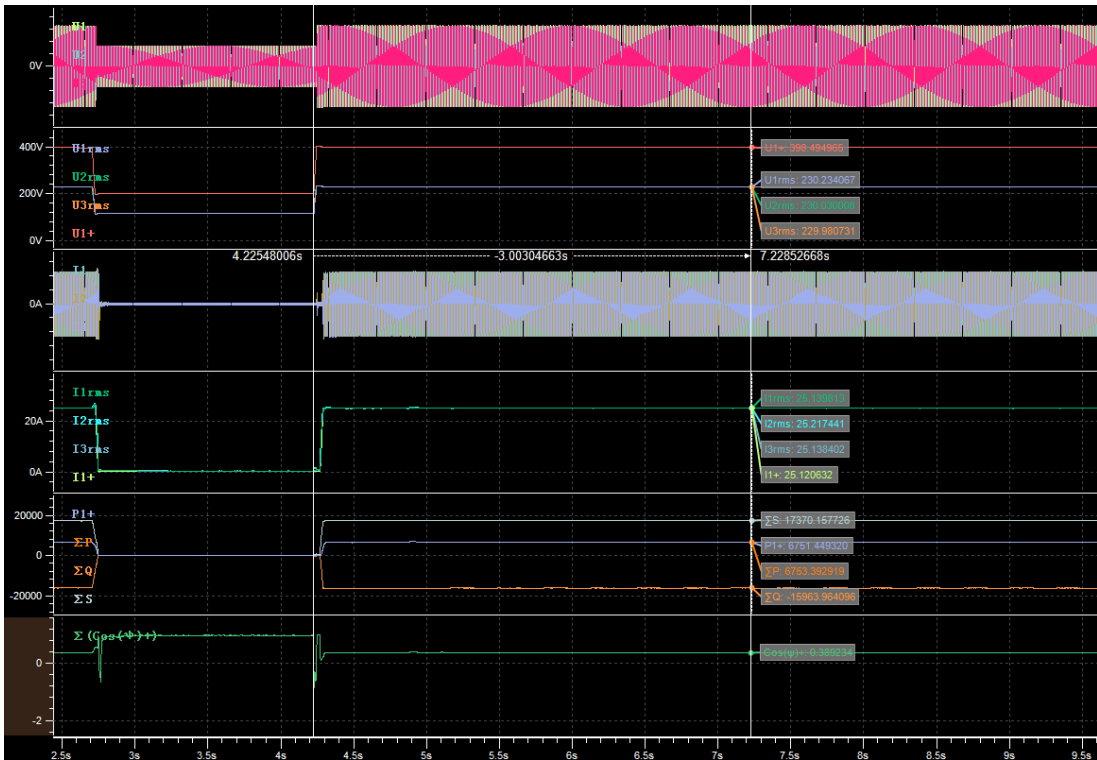

After dip (t2+3s)



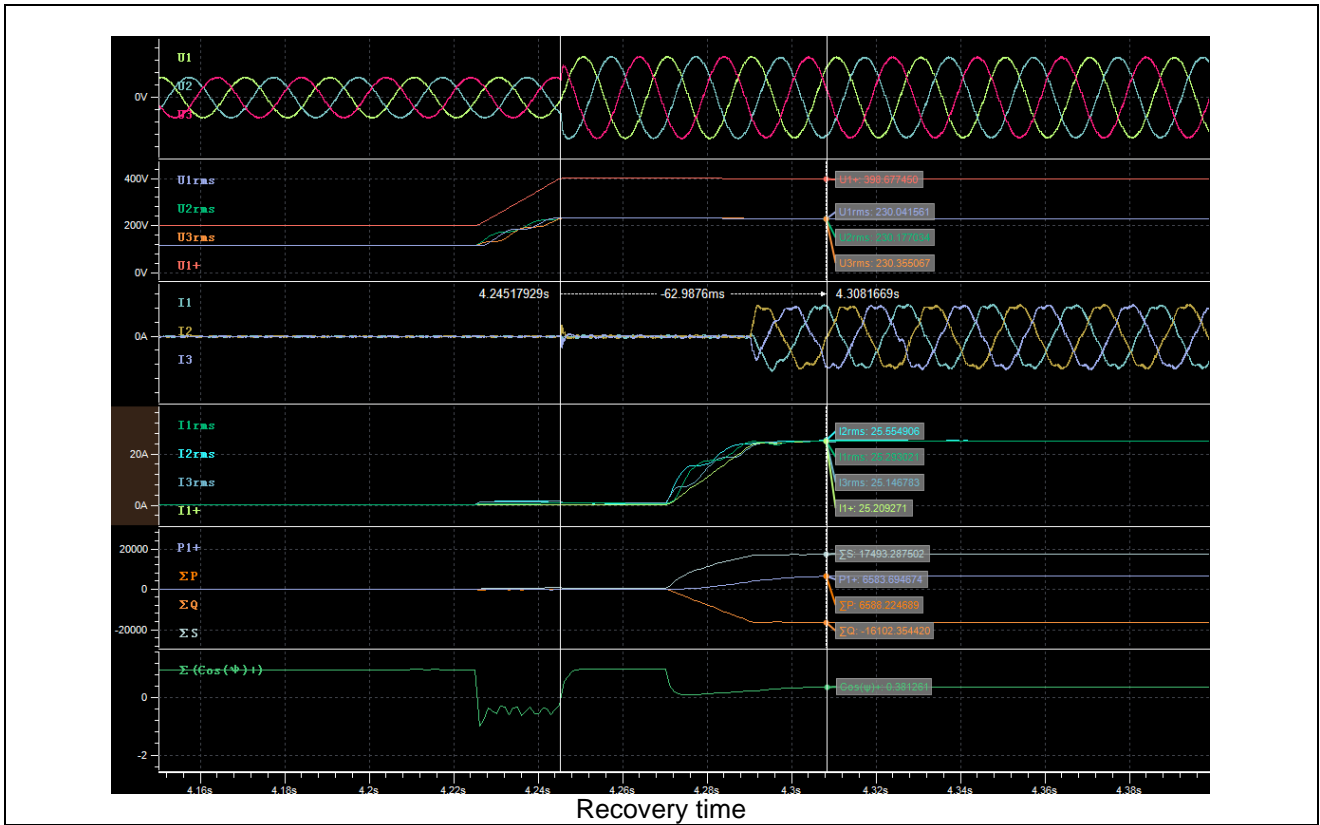

Graph of Test number 4.2

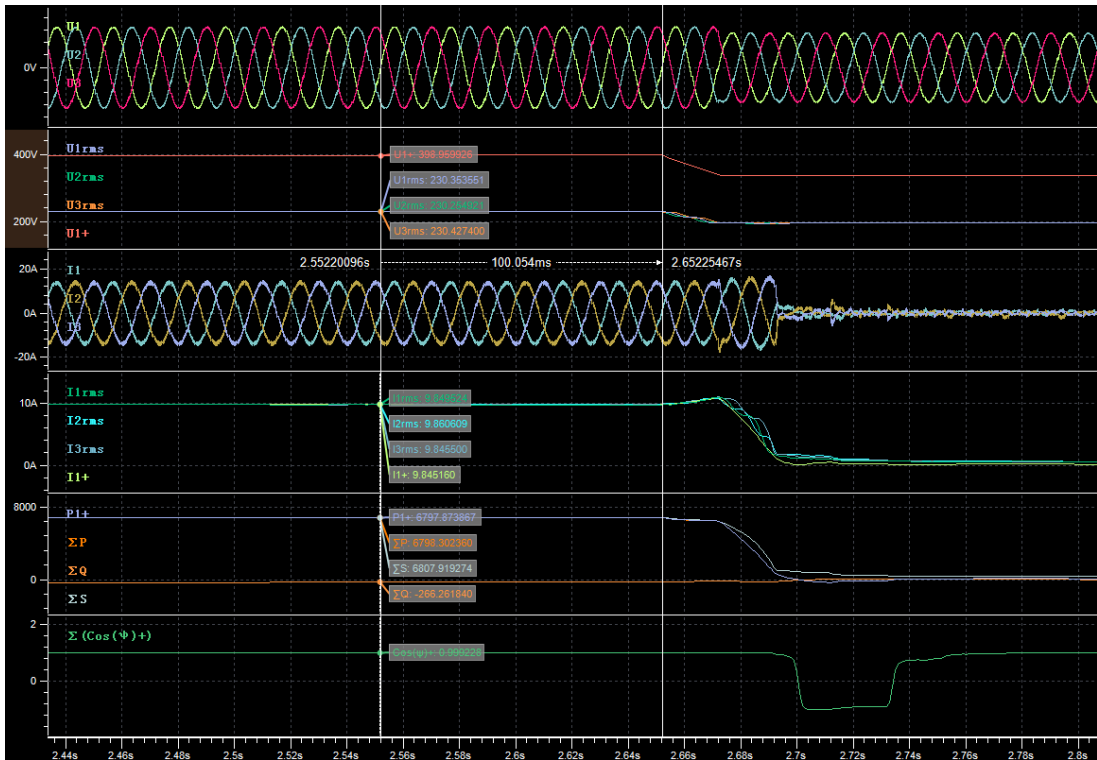

Before dip (t1-100ms)

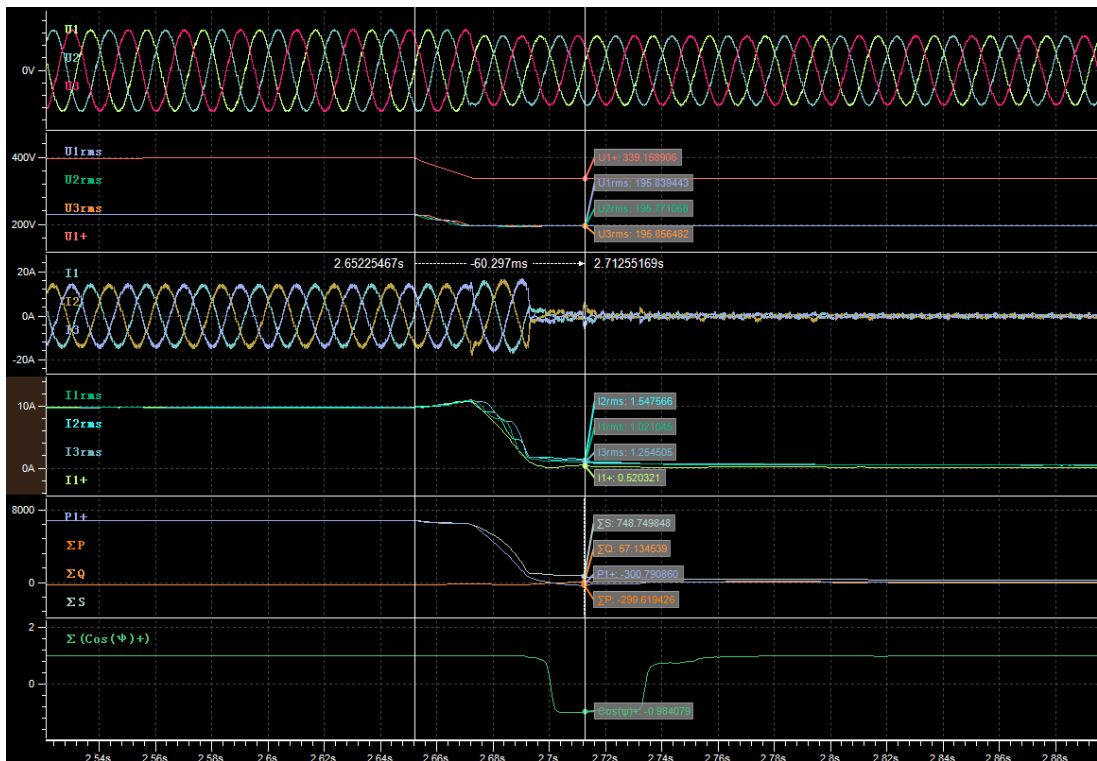

During dip (t1+60ms)

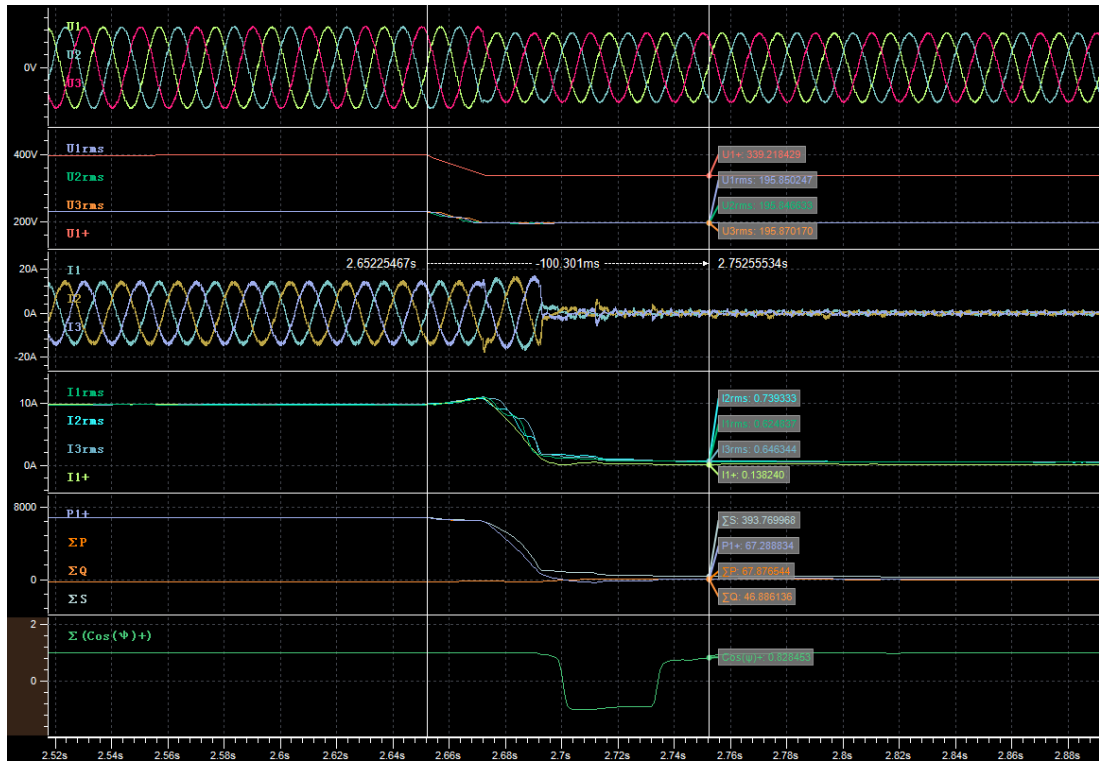

During dip (t1+100ms)

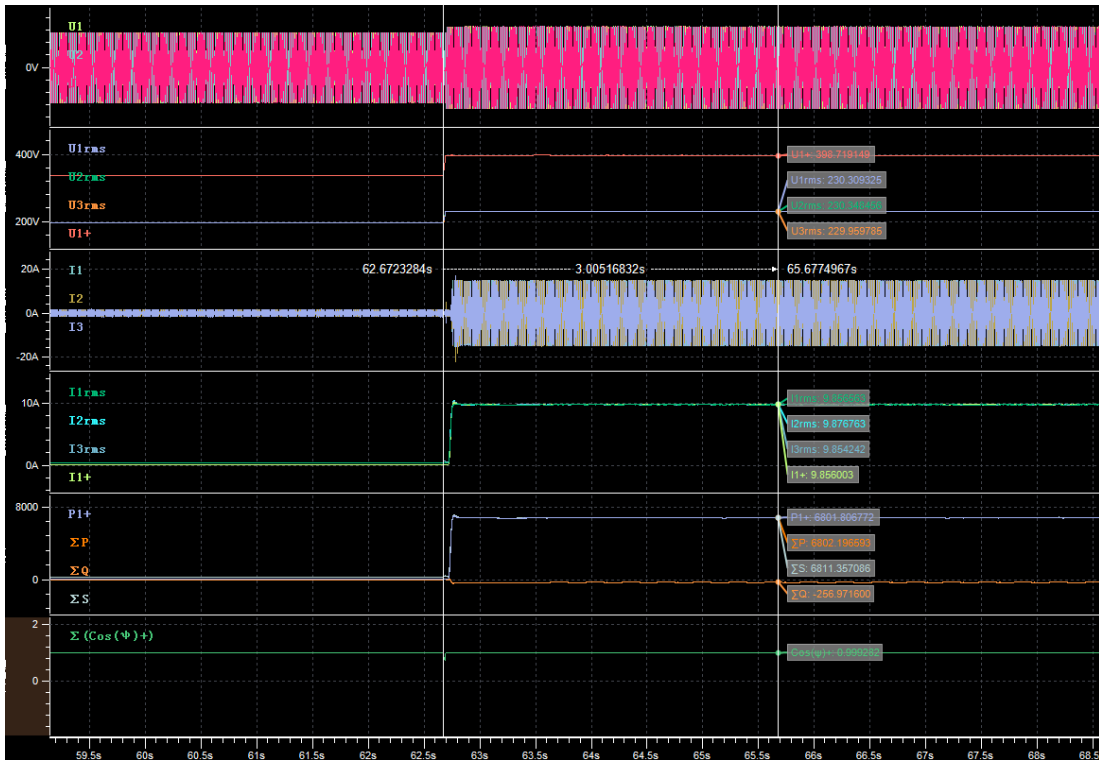

After dip (t2+3s)

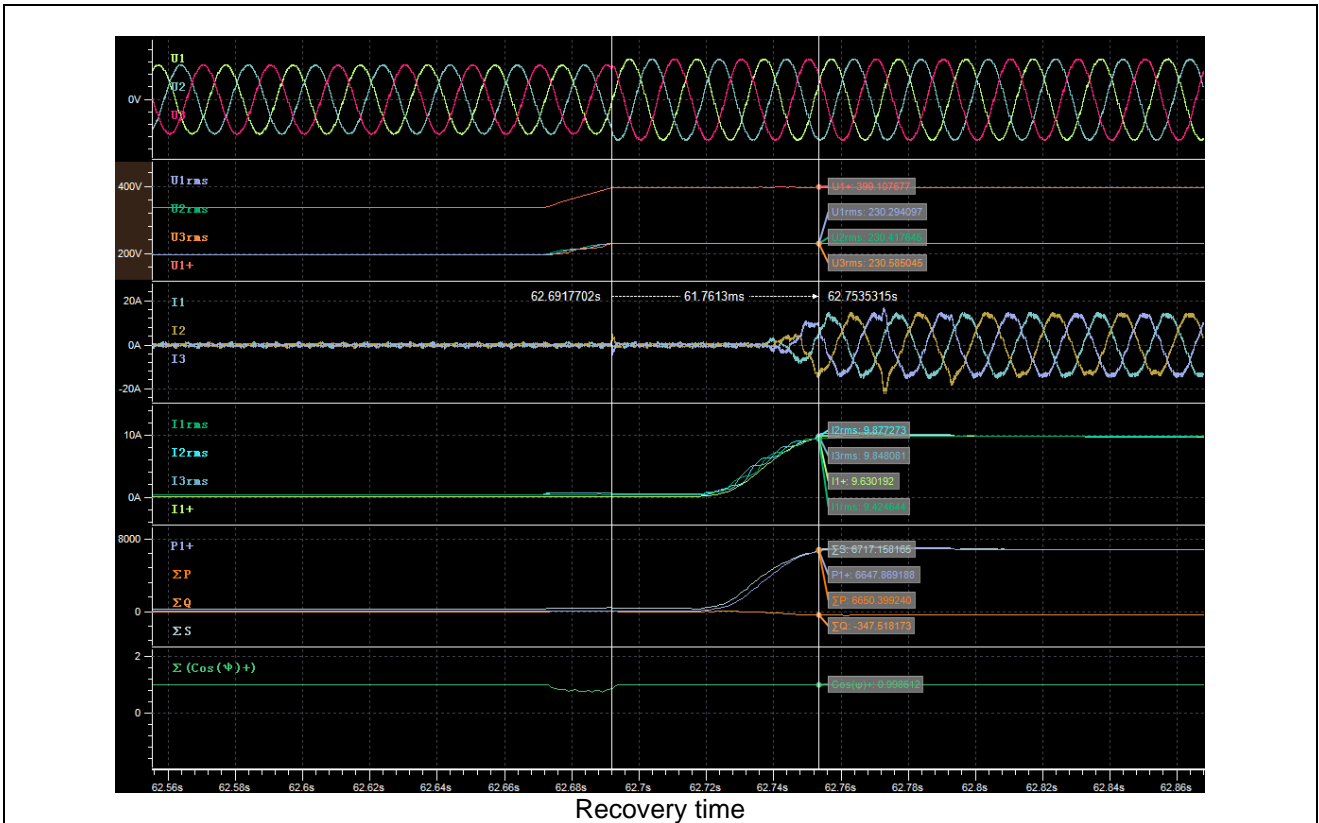

Graph of Test number 5.2

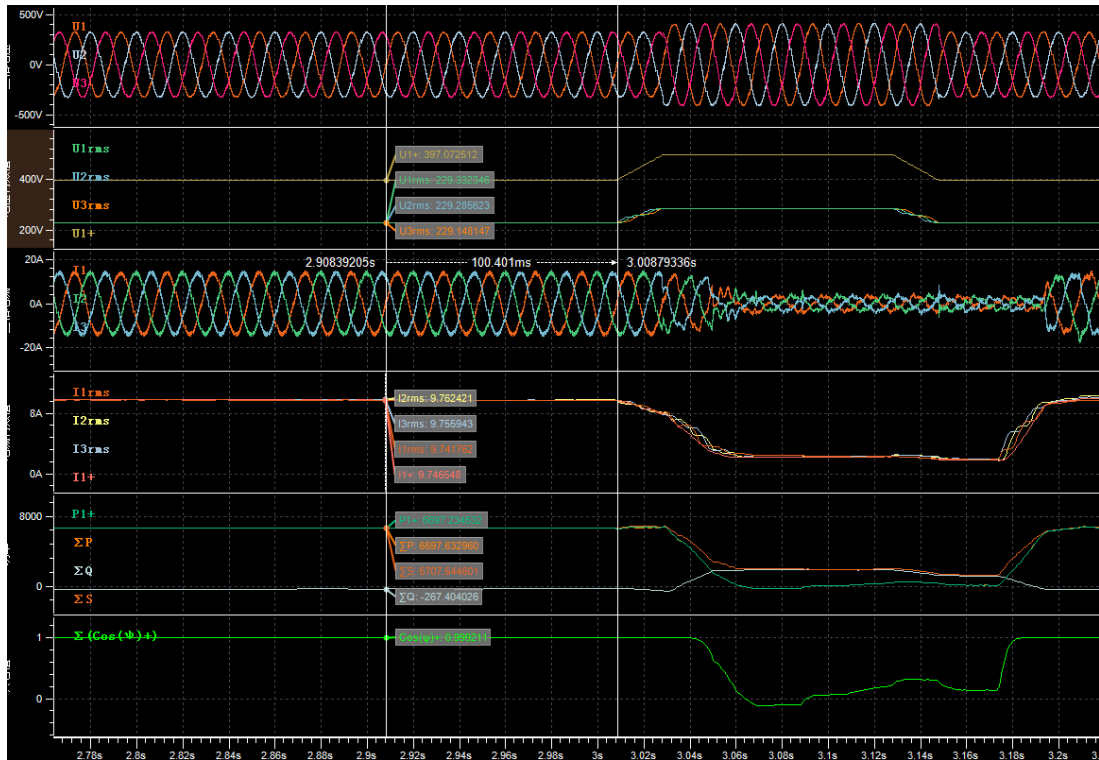

Before dip (t1-100ms)

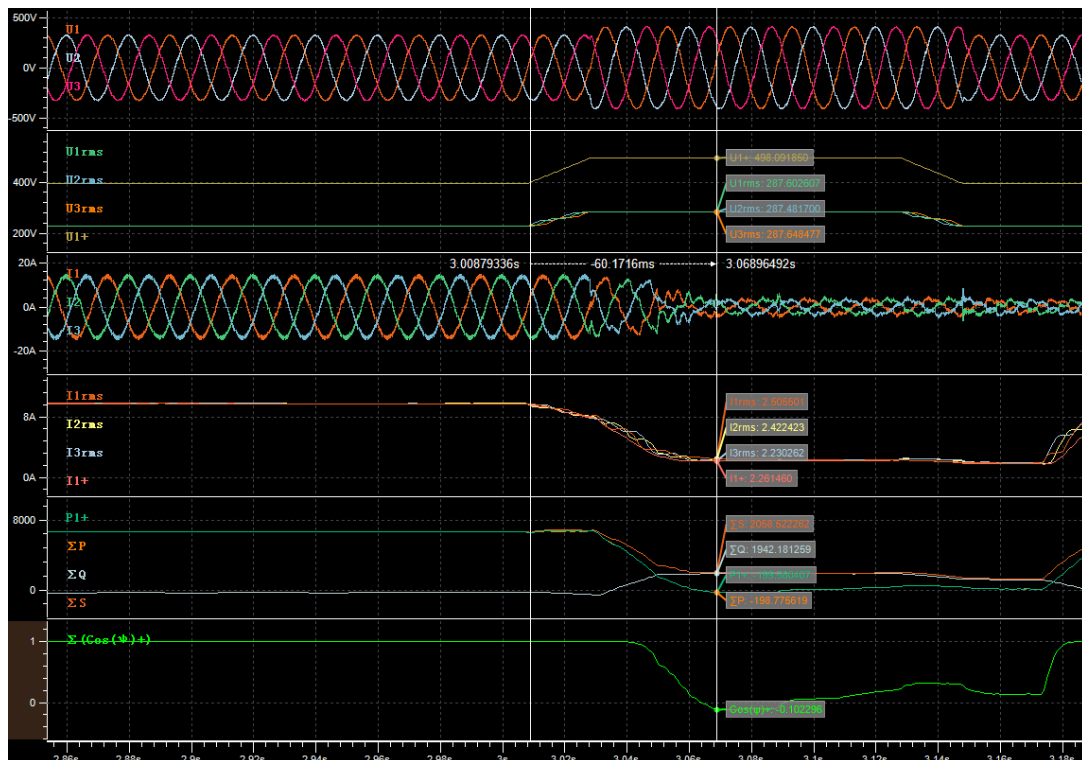

During dip (t1+60ms)

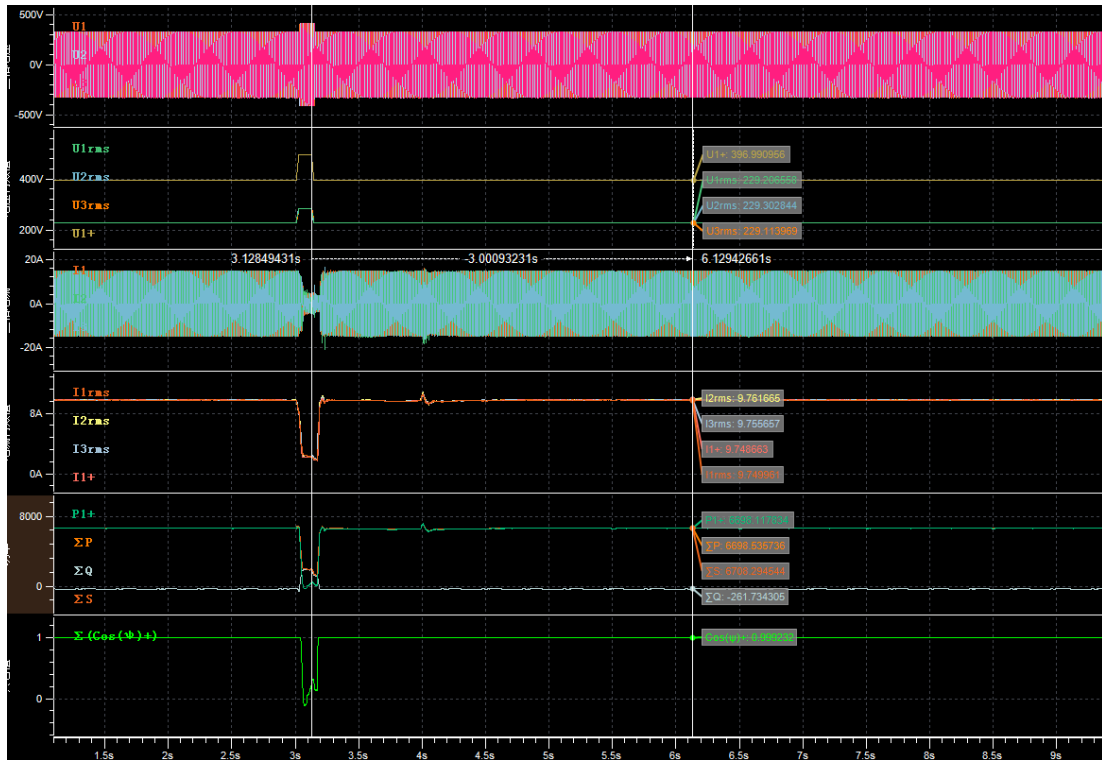
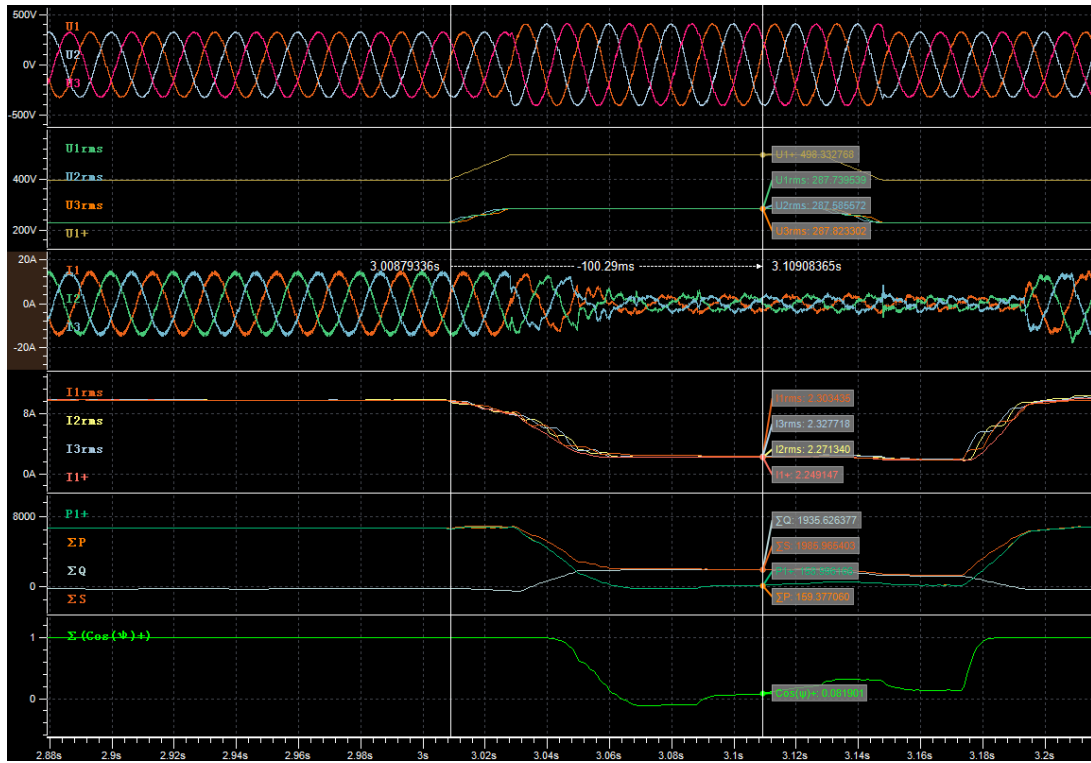

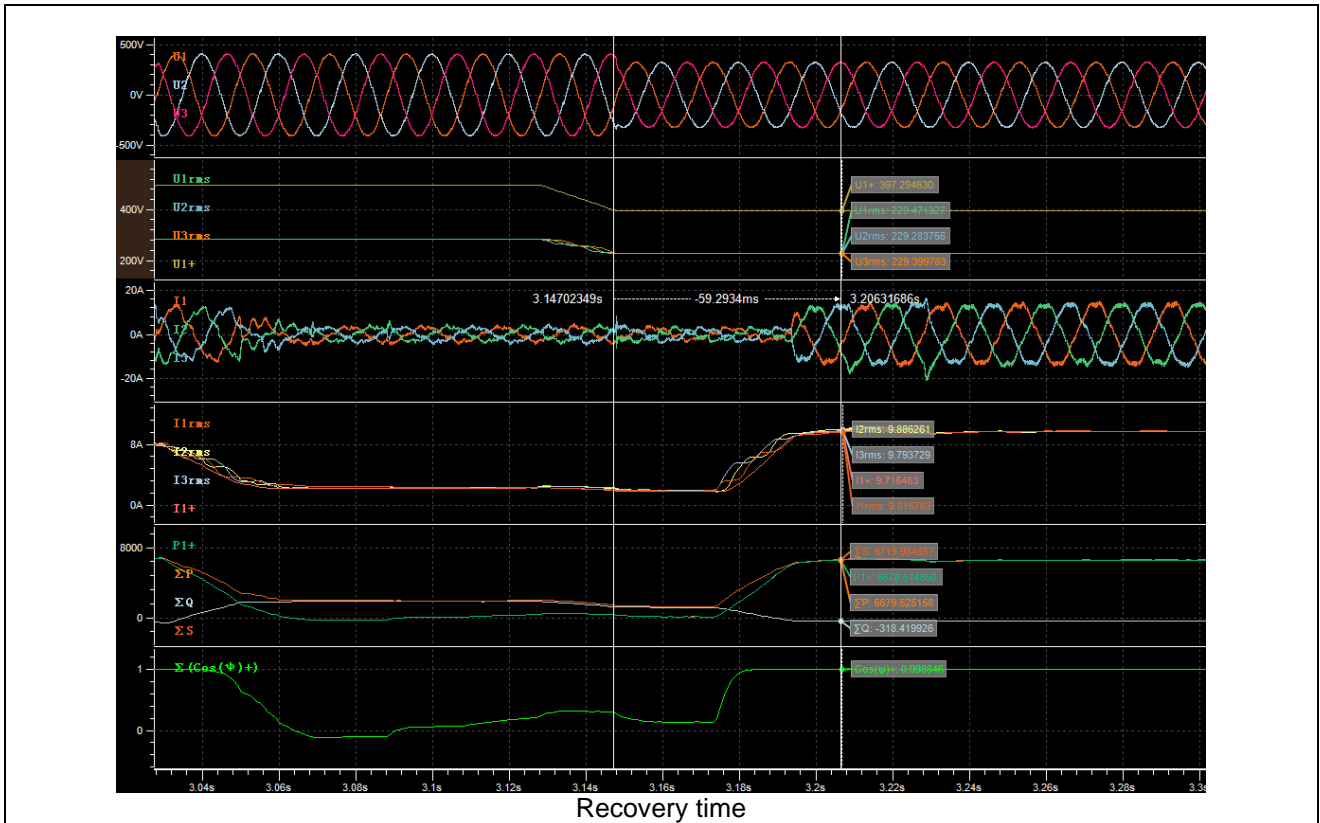

Verification of dynamic network support							P	
Short-circuited power at generator terminal [VA]			60K					
NS protection settings			See table 5.5 for detail.					
	No.	Parameter	Phase ref.	Time ref.	unit	Result		
General Info.	0	Test number	--	--	--	6.2	7.2	
	1	Date	--	--	dd.mm.yyyy	20-April-2020 to 20-May-2020		
	2	Time (start of test)	--	--	hh:mm:ss.f	See graph		
	3	Fault type (phase)	--	--		A	A	
	4	Setting voltage depth	Line to line	--	p.u.	1.20	1.15	
	5	Setting dip duration		--	ms	5000	60000	
	6	Point of fault entry	Total	--	ms	20ms		
	7	Point of fault clearance	Total	--	ms	20ms		
	8	Fault duration in empty load test	Total	--	ms	5007.6	60004	
	9	Voltage depth/height in empty load test	Total	t1+100ms to t2 and t1-10s to t1	p.u.	1.20	1.15	
10	Positive sequence		p.u.		1.197	1.145		
Before dip <t1	11	Voltage	Line to neutral	t1-10s to t1	p.u.	1.00	1.00	
	12	Current	Positive sequence	t1-500ms to t1-100ms	p.u.	0.20	0.21	
	13	Active power	Total	t1-10s to t1	p.u.	0.204	0.206	
	14		Positive sequence			0.204	0.206	
	15	Reactive power	Total	t1-10s to t1	p.u.	-0.006	-0.008	
	16		Positive sequence			-0.006	-0.008	
	17	Cos $\phi$	--	t1-10s to t1	--	0.9996	0.9992	
During dip t1 to t2	18	Voltage	Line to neutral	t1+100ms to t2-20ms	p.u.	1.203	1.153	
	19	Line current	Phase 1	t1+60ms	p.u.	0.049	0.051	



	20		Phase 2			0.051	0.050
	21		Phase 3			0.045	0.047
	22	Line current	Phase 1	t1+100ms	p.u.	0.048	0.046
	23		Phase 2			0.047	0.045
	24		Phase 3			0.047	0.045
	25	Active power	Total	t1+100ms to t2-20ms	p.u.	0.008	0.008
26	Positive sequence		0.008			0.008	
After dip > t2	27	Voltage	Line to neutral	t2+3s to t2+10s	p.u.	1.00	1.00
	28	Active power	Positive sequence.	t2+3s to t2+10s	p.u.	0.204	0.206
	29		Total			0.204	0.206
	39	Active power rising time	Positive sequence	--	s	0.052	0.048
	31	Reactive power	Positive sequence	t2+3s to t2+10s	p.u.	-0.008	-0.008
	32		Total			-0.008	-0.008
	33	Reactive power rising time	Positive sequence	--	s	0.052	0.048
	34	PGU does not disconnect from grid till 60s after fault	--	t2 to t2+60s	Yes / No	Yes	

Graph of Test number 6.2

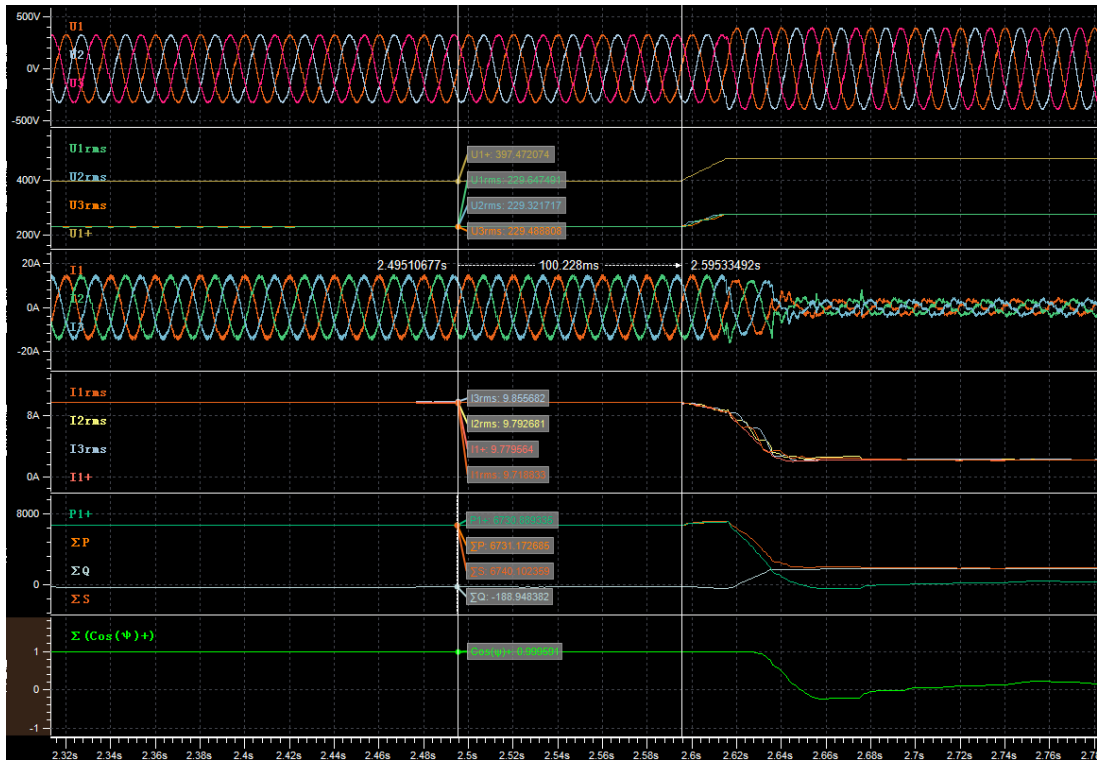

Before dip (t1-100ms)

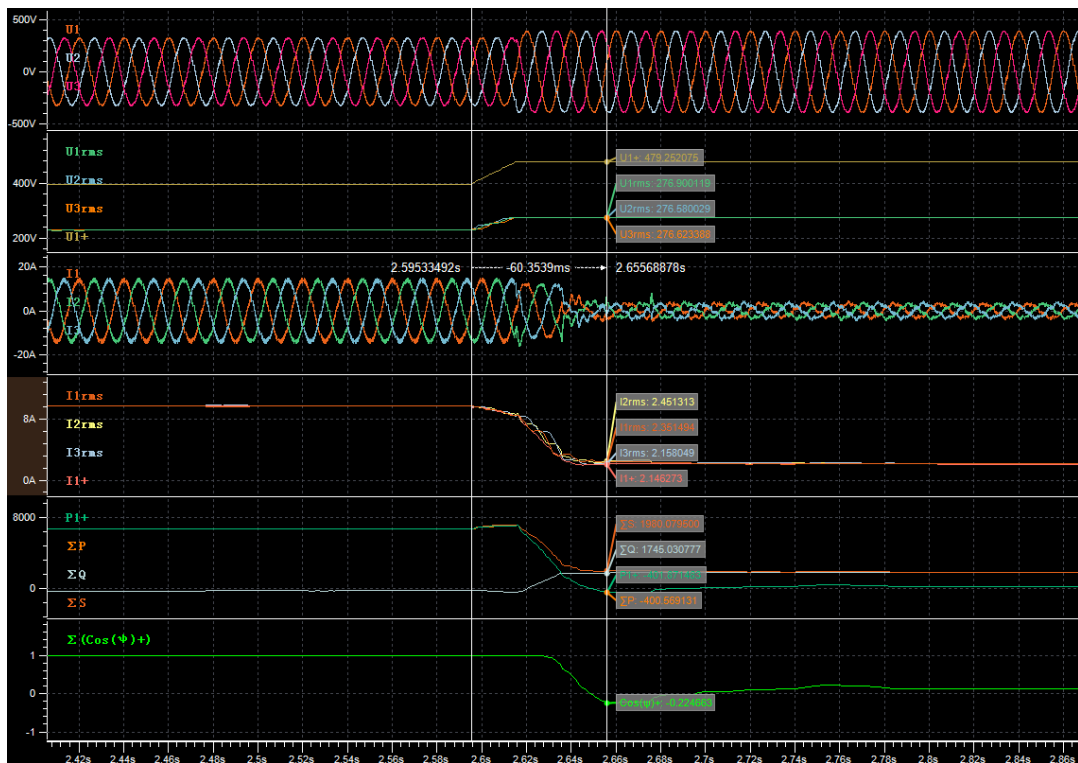

During dip (t1+60ms)

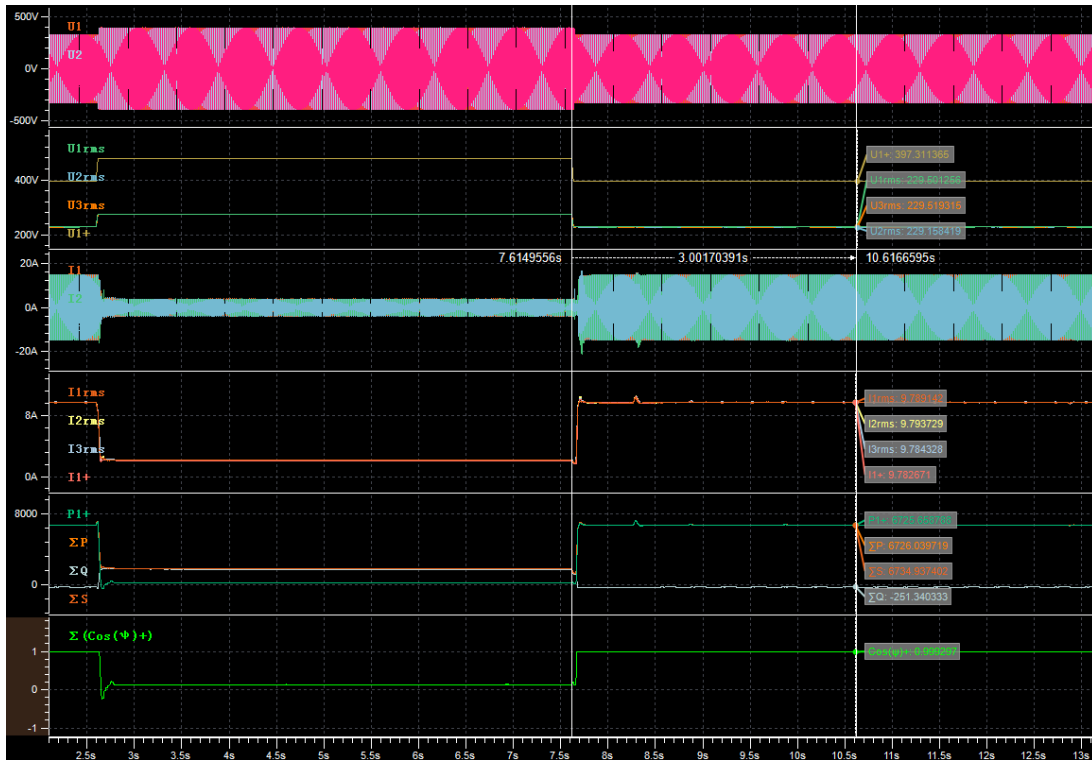
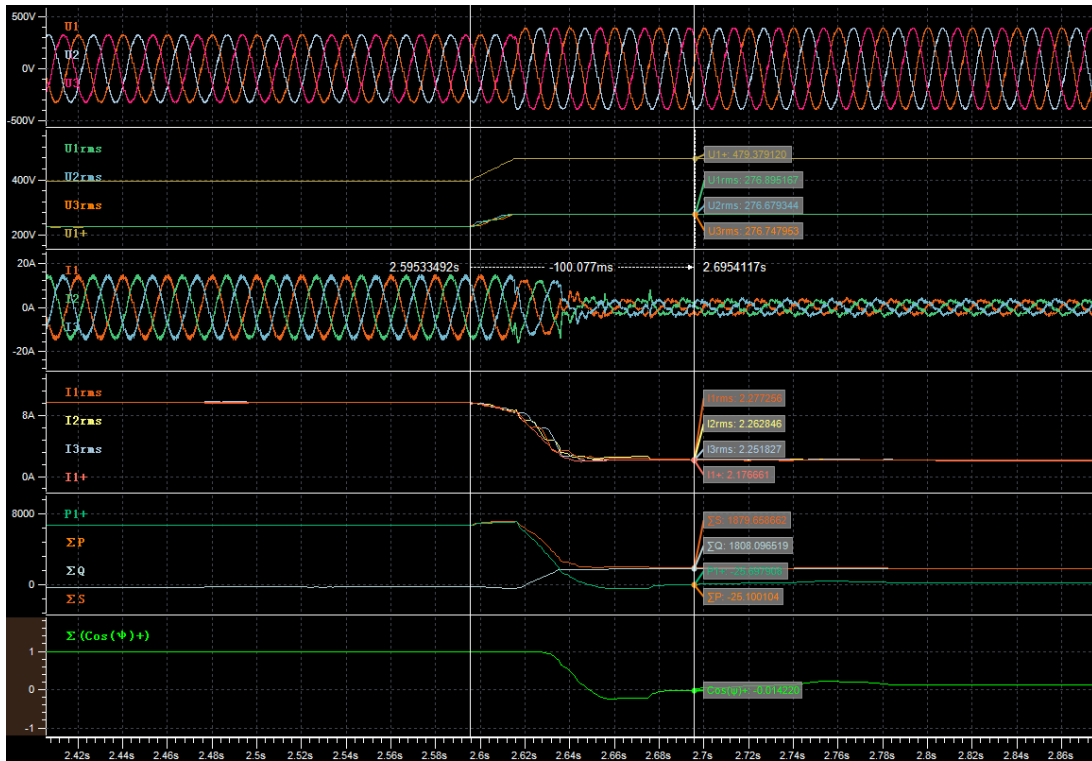

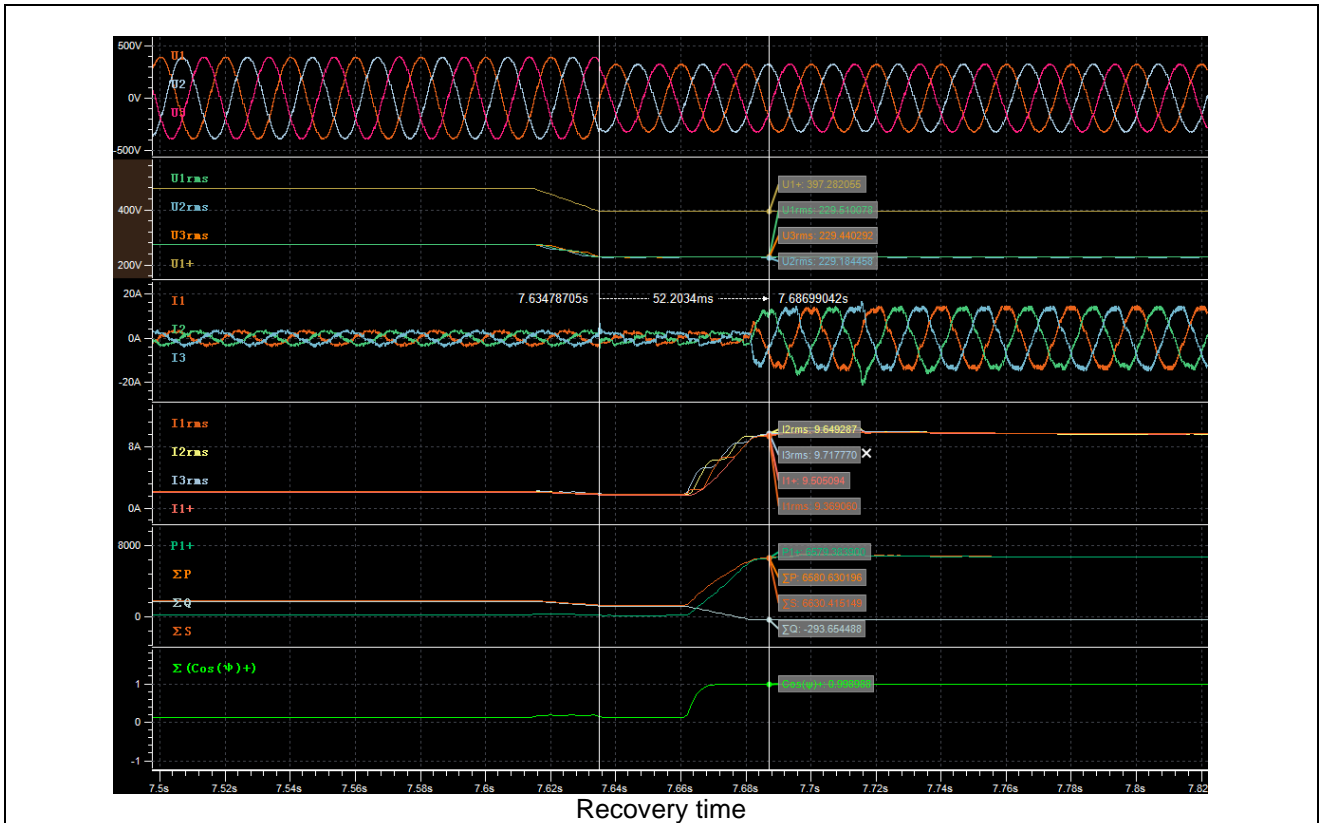

Graph of Test number 7.2

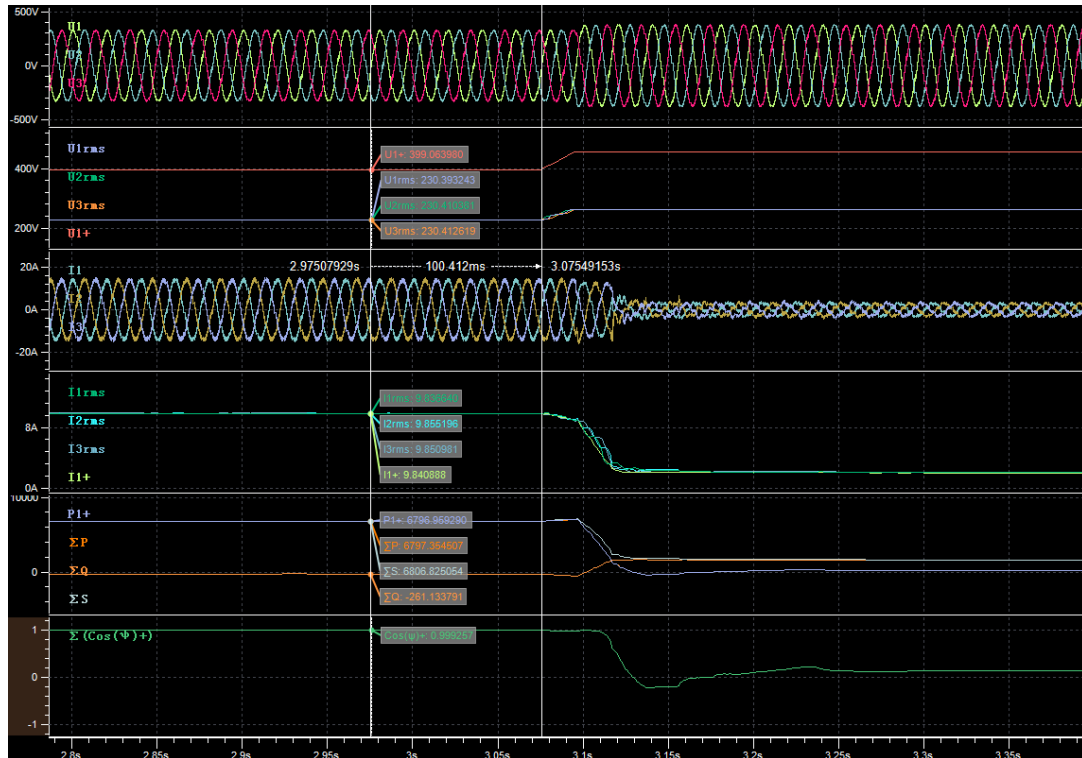

Before dip (t1-100ms)

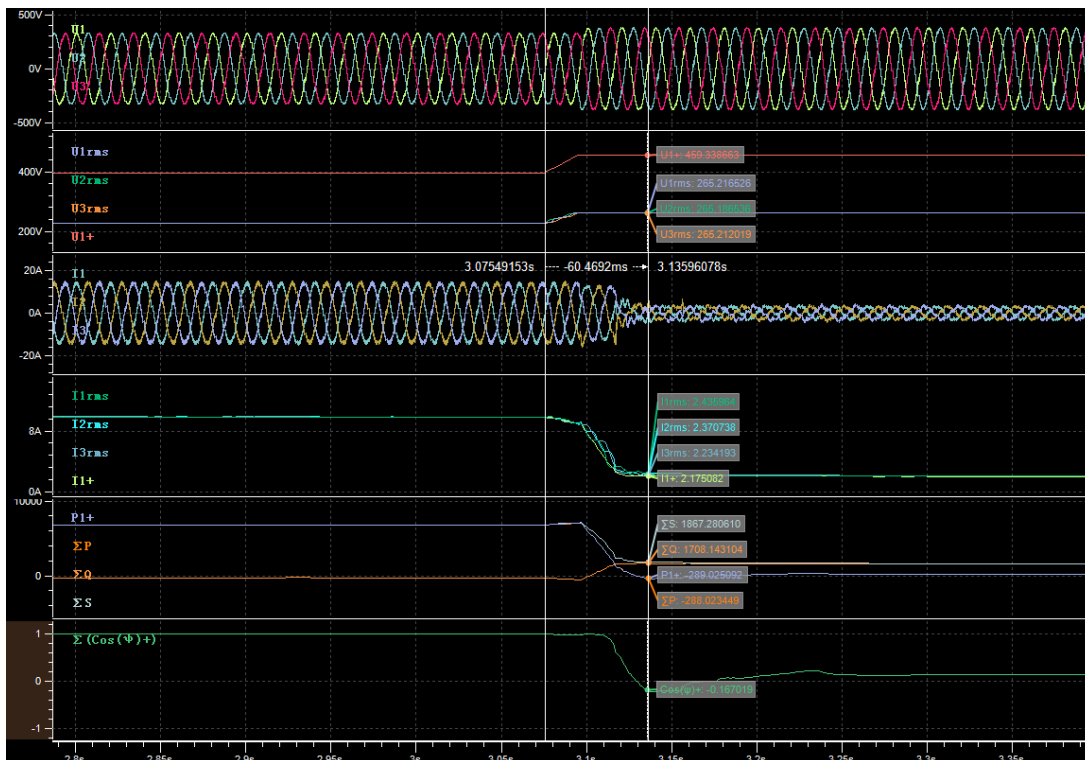

During dip (t1+60ms)

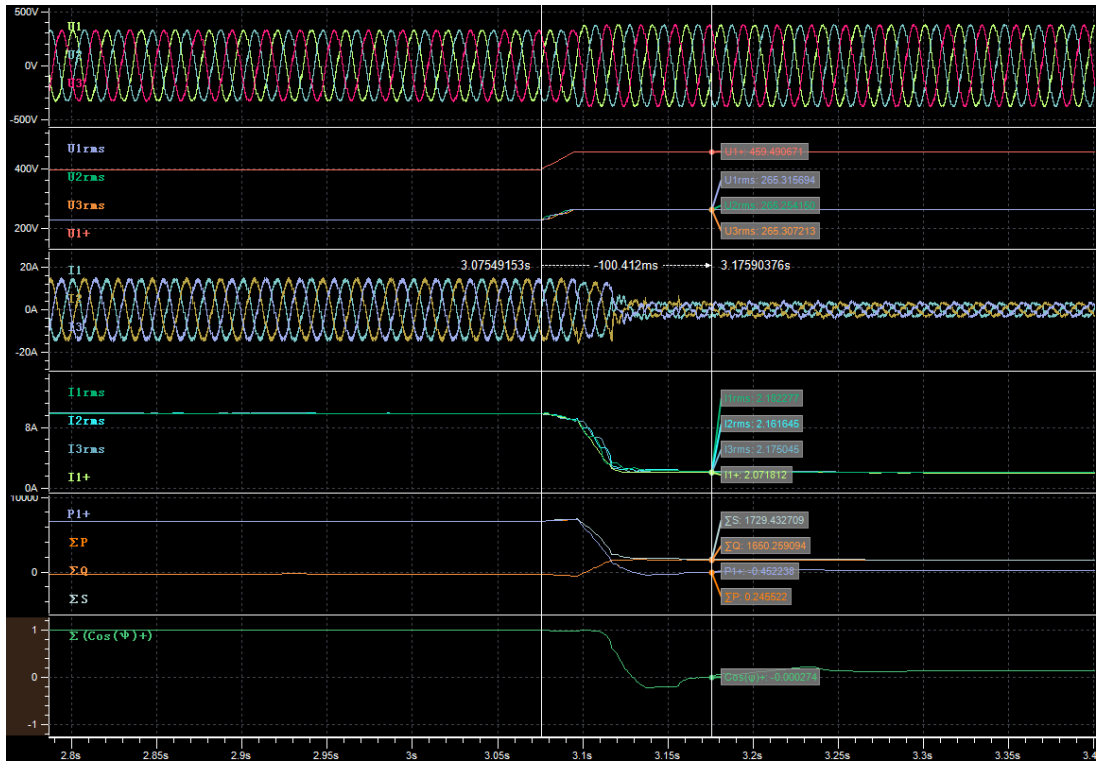

During dip (t1+100ms)

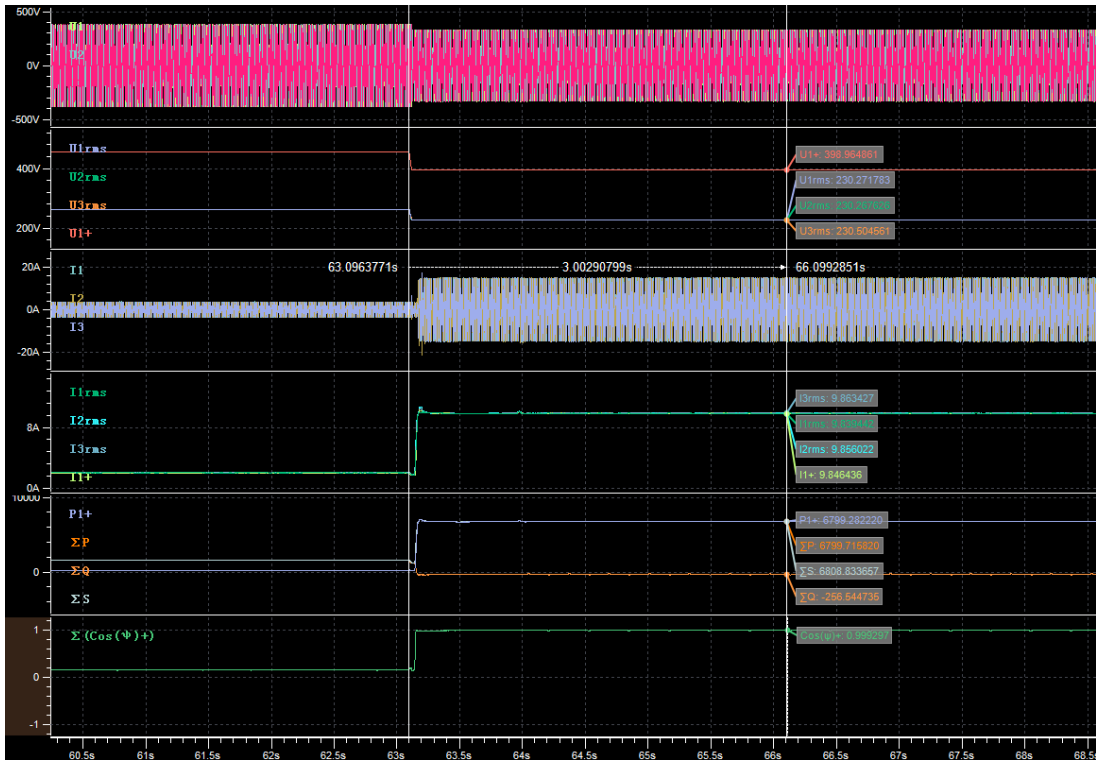

After dip (t2+3s)

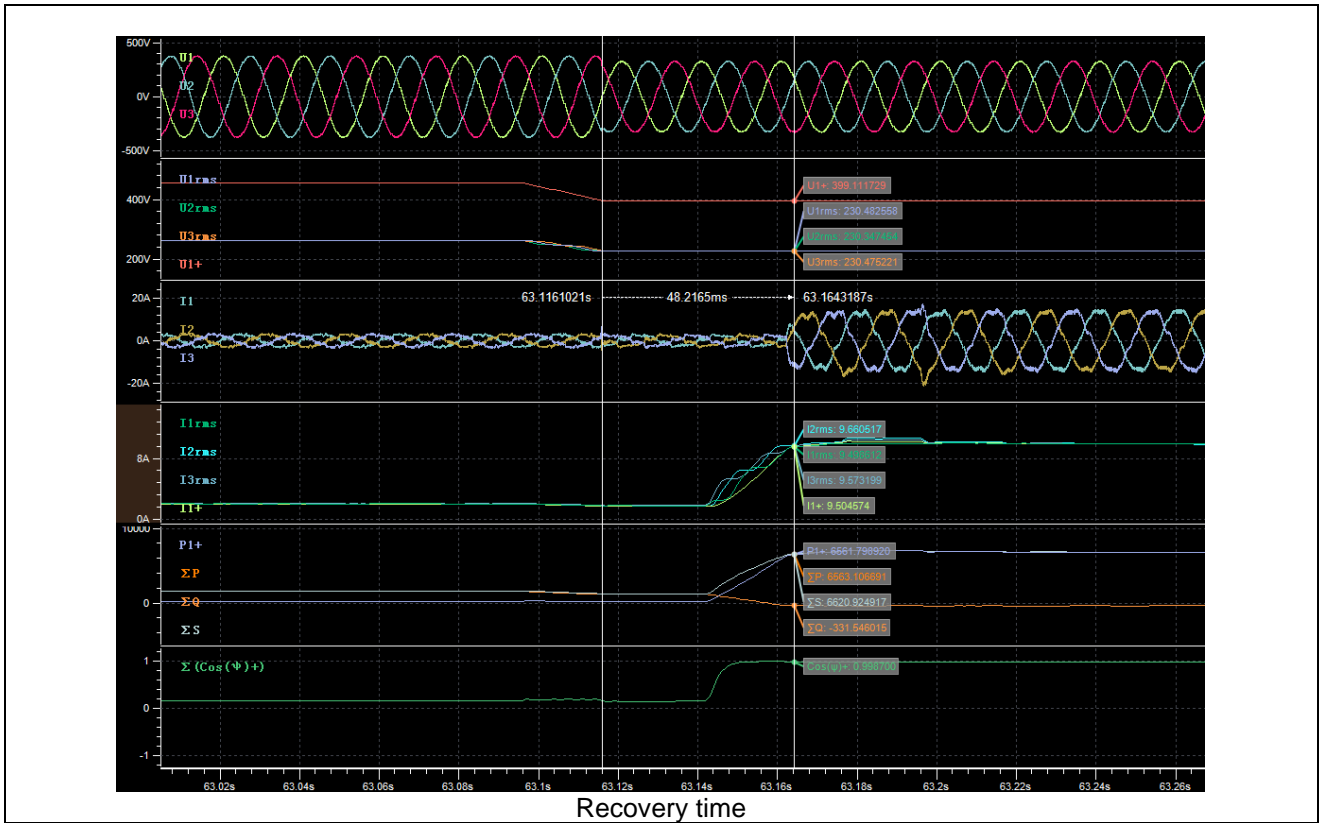

Verification of dynamic network support								P	
Short-circuited power at generator terminal [VA]			60K						
NS protection settings			See table 5.5 for detail.						
	No.	Parameter	Phase ref.	Time ref.	unit	Result			
General Info.	0	Test number	--	--	--	1.3	2.3	3.3	4.3
	1	Date	--	--	dd.mm.yyyy	20-April-2020 to 20-May-2020			
	2	Time (start of test)	--	--	hh:mm:ss.f	See graph			
	3	Fault type (phase)	--	--		D1	D1	D1	D1
	4	Setting voltage depth	Line to line	--	p.u.	0.15	0.50	0.50	0.85
	5	Setting dip duration		--	ms	150	1500	1500	60000
	6	Point of fault entry	Total	--	ms	20ms			
	7	Point of fault clearance	Total	--	ms	20ms			
	8	Fault duration in empty load test	Total	--	ms	159.53	1502.4	1502.2	60002
	9	Voltage depth/height in empty load test	Total	t1+100ms to t2 and t1-10s to t1	p.u.	0.622	0.761	0.761	0.932
10	Positive sequence					0.429	0.663	0.662	0.901
Before dip <t1	11	Voltage	Line to neutral	t1-10s to t1	p.u.	1.00	1.00	1.00	1.00
	12	Current	Positive sequence	t1-500ms to t1-100ms	p.u.	1.00	1.09	1.12	1.01
	13	Active power	Total	t1-10s to t1	p.u.	1.01	1.01	1.01	1.01
	14		Positive sequence			1.01	1.01	1.01	1.01
	15	Reactive power	Total	t1-10s to t1	p.u.	0.002	0.499	-0.484	-0.009
	16		Positive sequence			0.002	0.499	-0.484	-0.009
	17	Cos $\phi$	--	t1-10s to t1	--	0.9999	0.8959	0.9011	0.9999
During	18	Voltage	Phase 1	t1+100ms	p.u.	0.622	0.762	0.762	0.932



dip t1 to t2			Phase 2	to t2-20ms		0.150	0.500	0.501	0.851
			Phase 3			0.622	0.762	0.762	0.932
	19	Line current	Phase 1	t1+60ms	p.u.	0.019	0.024	0.022	0.024
	20		Phase 2			0.022	0.027	0.025	0.034
	21		Phase 3			0.026	0.029	0.024	0.031
	22	Line current	Phase 1	t1+100ms	p.u.	0.015	0.017	0.015	0.013
	23		Phase 2			0.019	0.022	0.021	0.017
	24		Phase 3			0.024	0.025	0.022	0.019
	25	Active power	Total	t1+100ms to t2-20ms	p.u.	0.003	0.003	0.003	0.003
26	Positive sequence		0.003			0.003	0.003	0.003	
After dip > t2	27	Voltage	Line to neutral	t2+3s to t2+10s	p.u.	1.00	1.00	1.00	1.00
	28	Active power	Positive sequence.	t2+3s to t2+10s	p.u.	1.01	1.00	1.01	1.01
	29		Total			1.01	1.00	1.01	1.01
	39	Active power rising time	Positive sequence	--	s	0.112	0.195	0.191	0.148
	31	Reactive power	Positive sequence	t2+3s to t2+10s	p.u.	0.007	0.482	-0.491	-0.010
	32		Total			0.007	0.482	-0.491	-0.010
	33	Reactive power rising time	Positive sequence	--	s	0.112	0.195	0.191	0.148
	34	PGU does not disconnect from grid till 60s after fault	--	t2 to t2+60s	Yes / No	Yes			

Graph of Test number 1.3

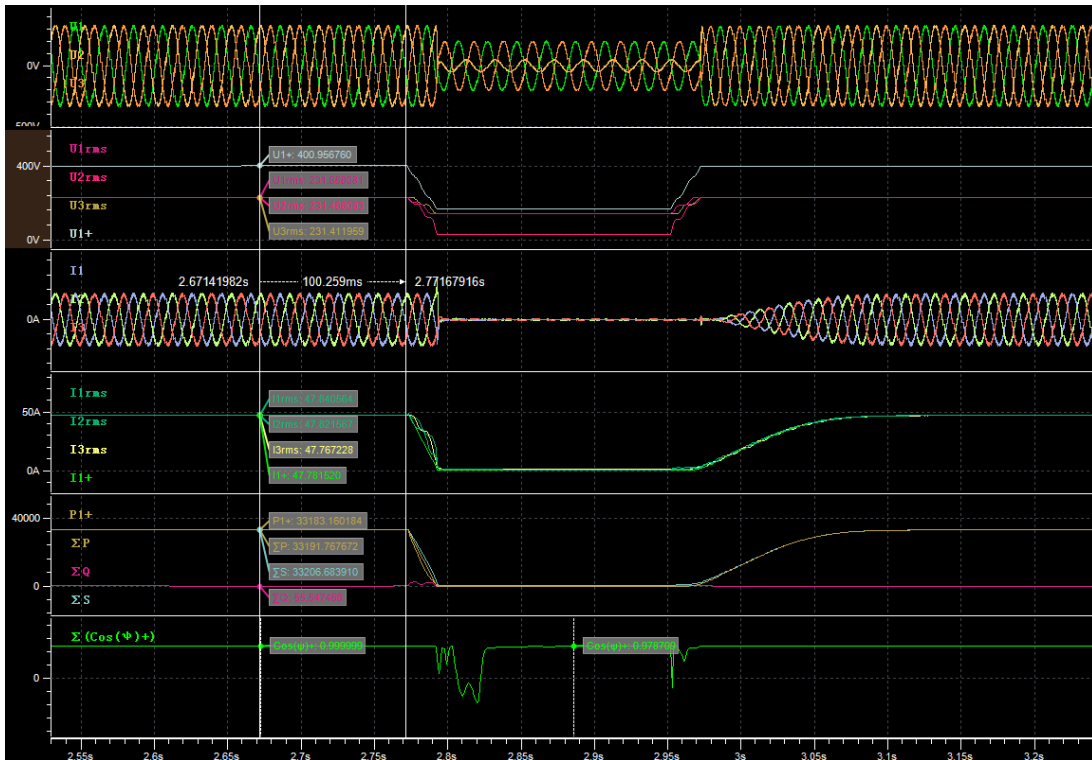
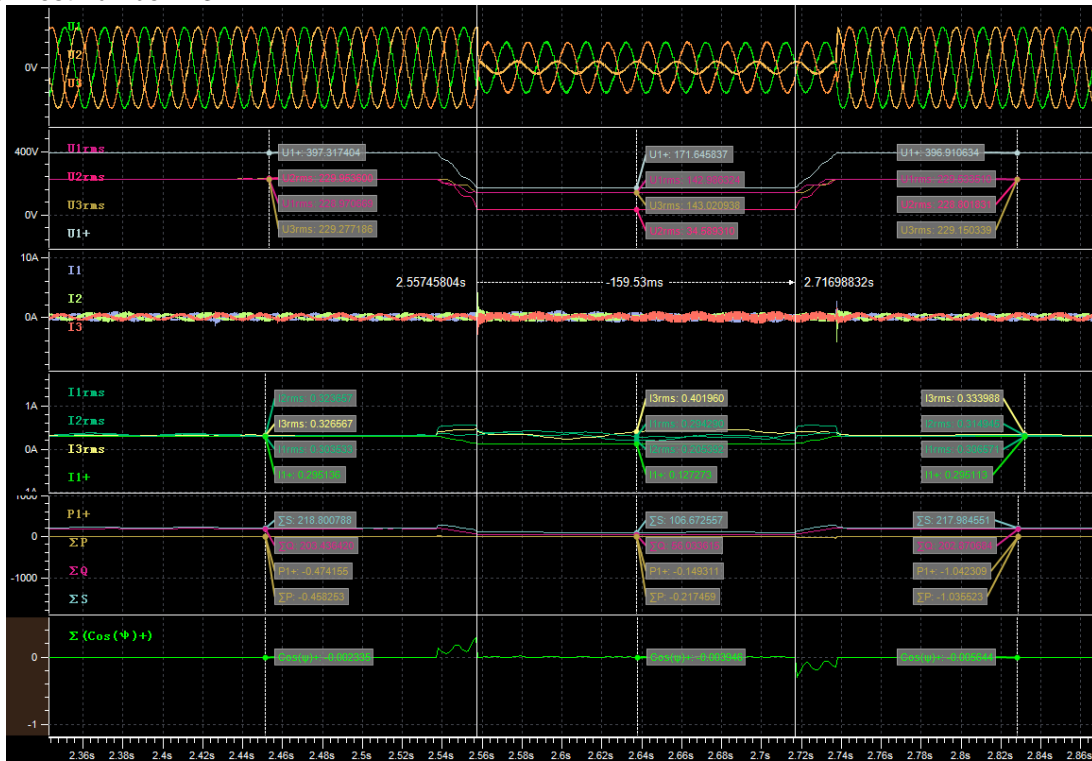

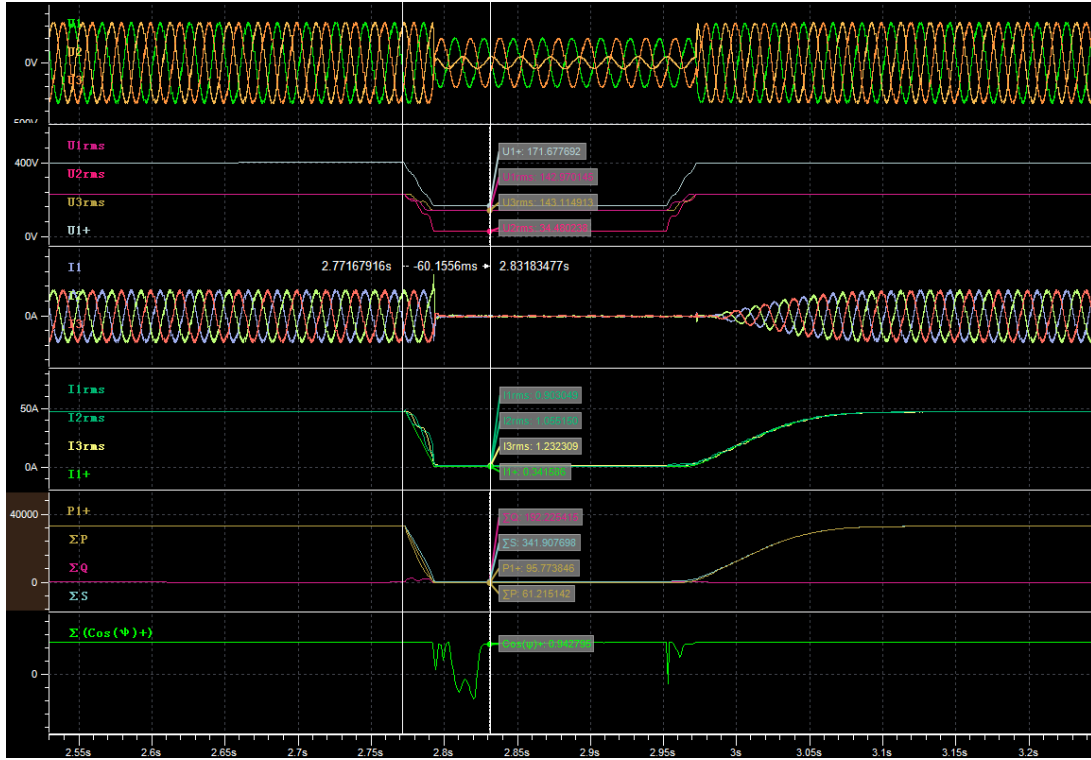

During dip (t1+60ms)

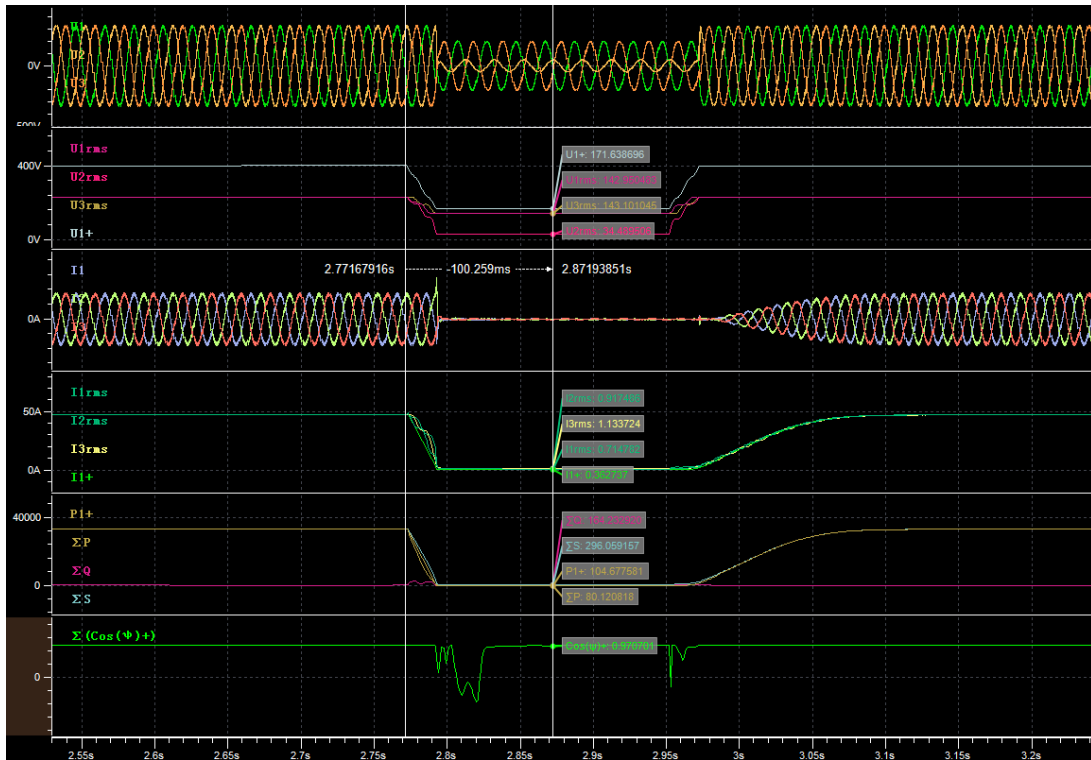

During dip (t1+100ms)

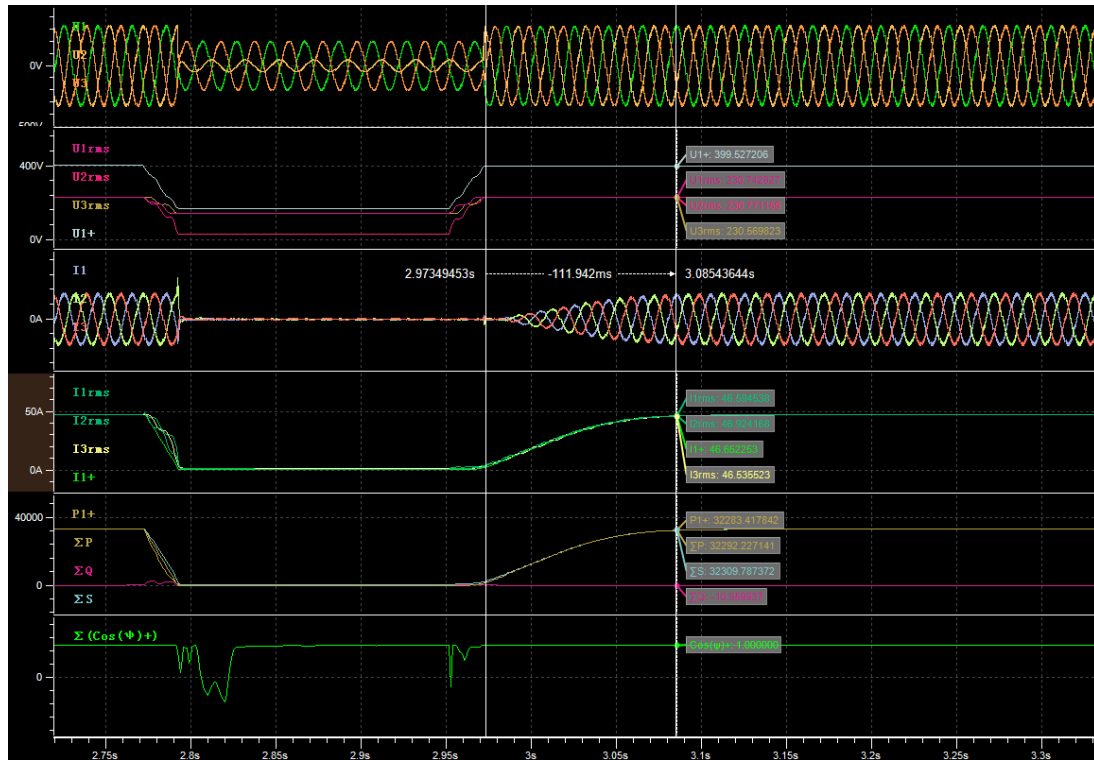
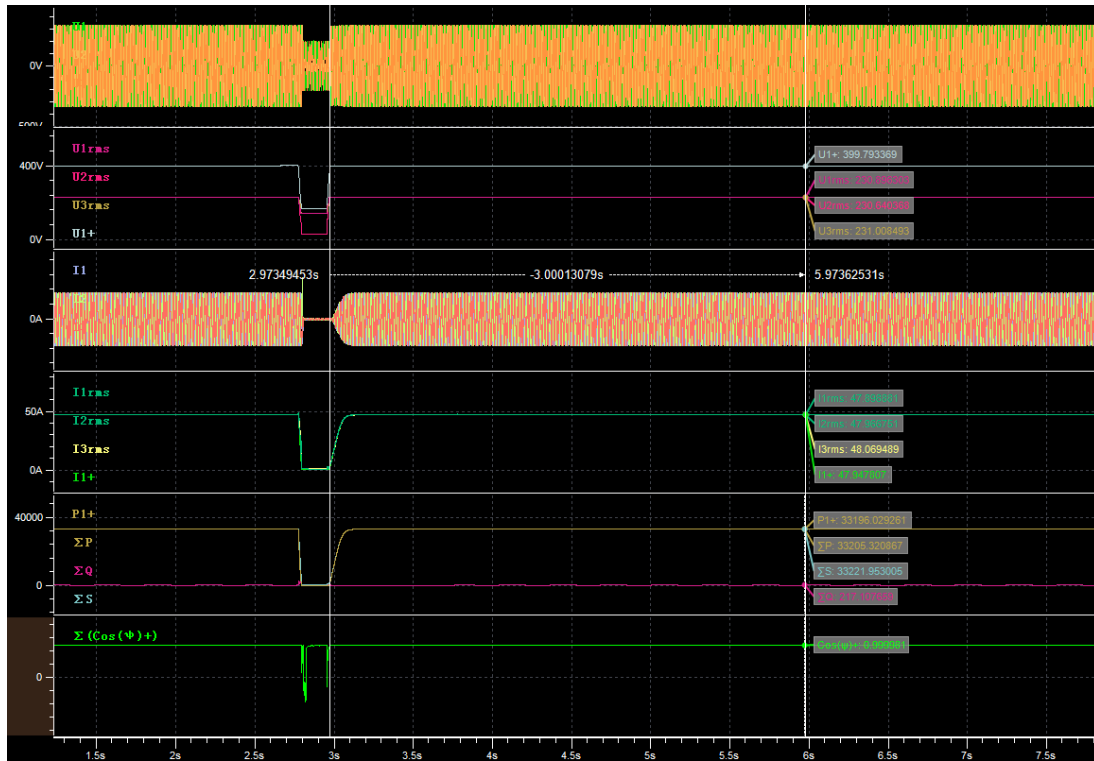

Graph of Test number 2.3

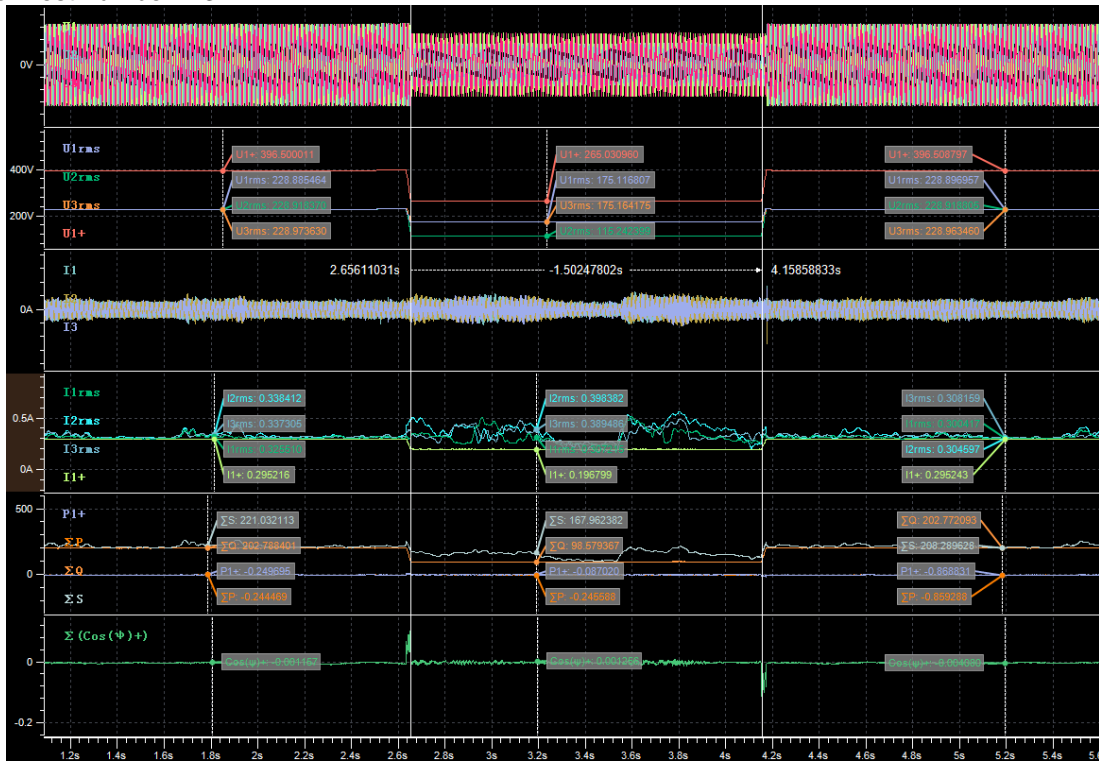

Empty load

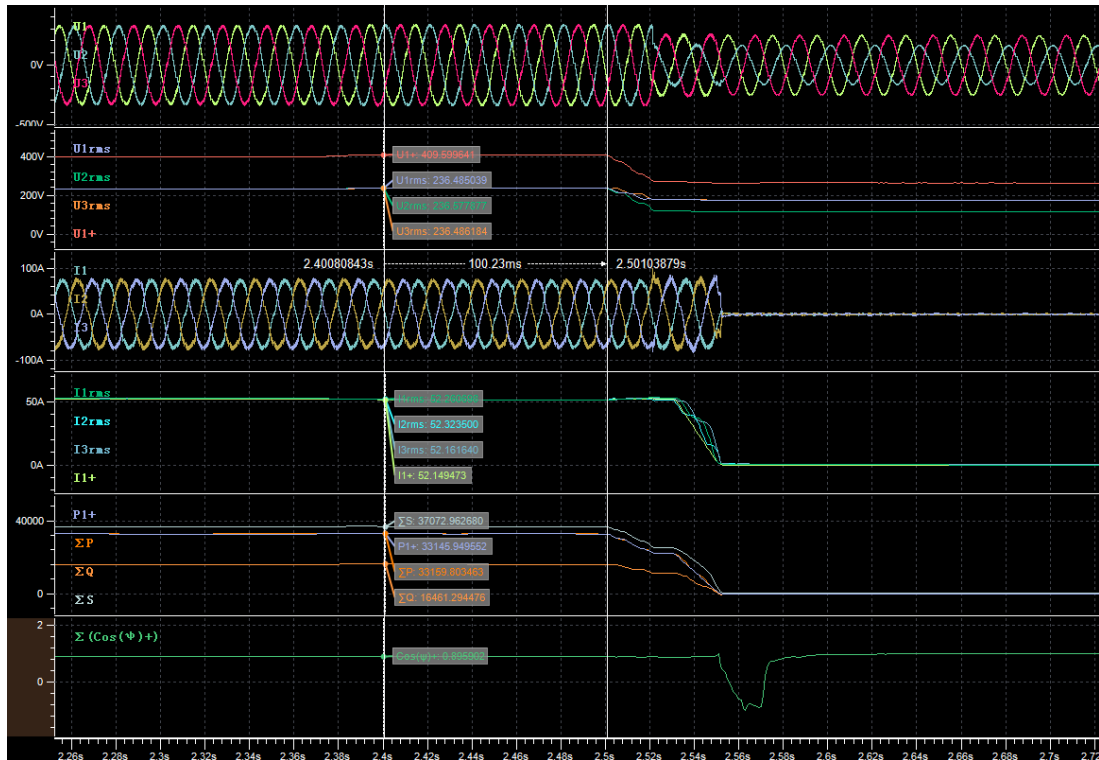

Before dip (t1-100ms)

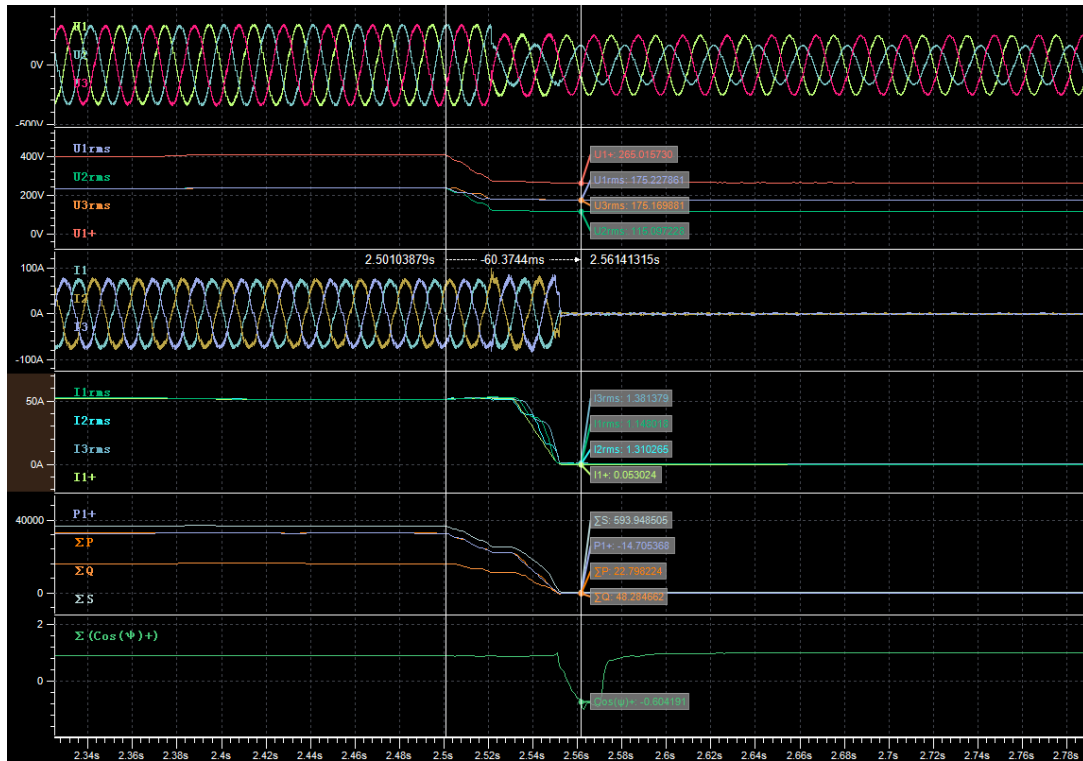

During dip (t1+60ms)

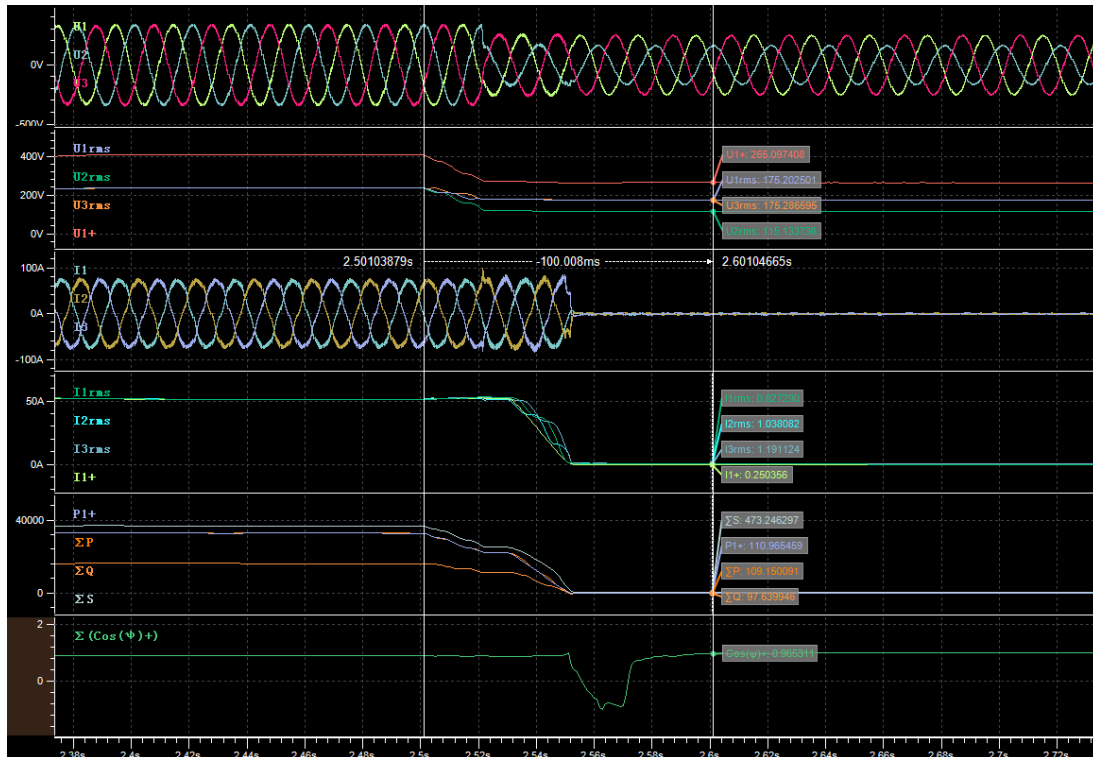

During dip (t1+100ms)

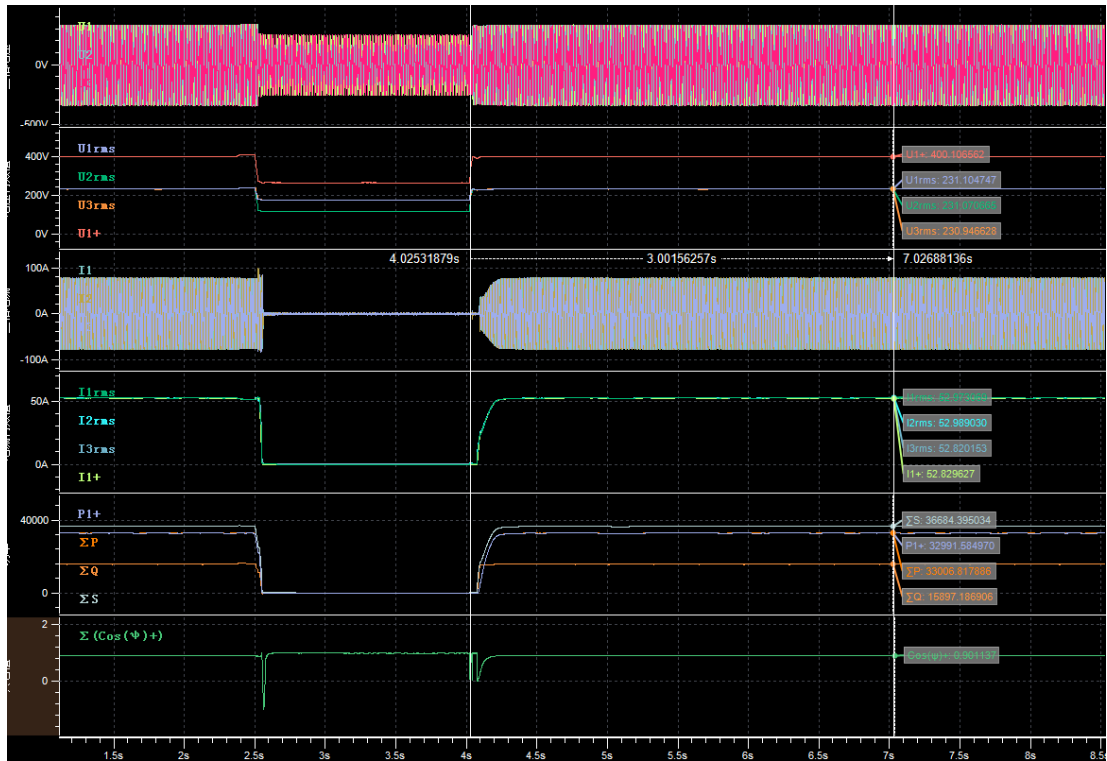

After dip (t2+3s)

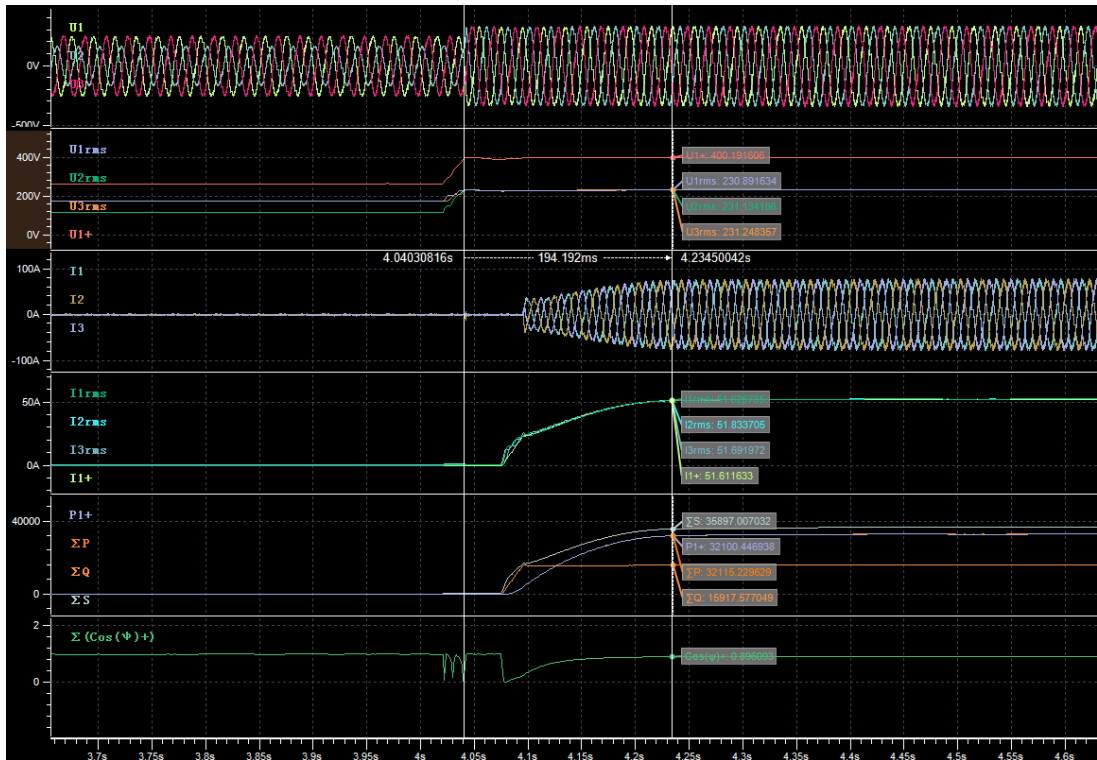

Recovery time

Graph of Test number 3.3

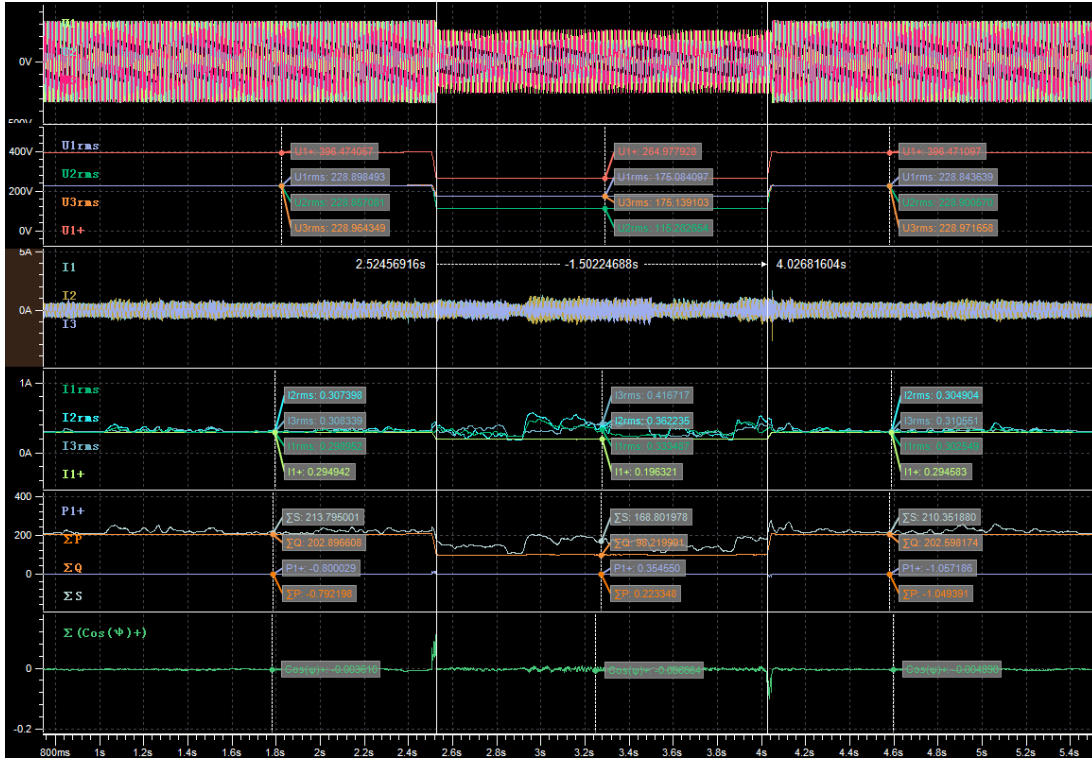

Empty load

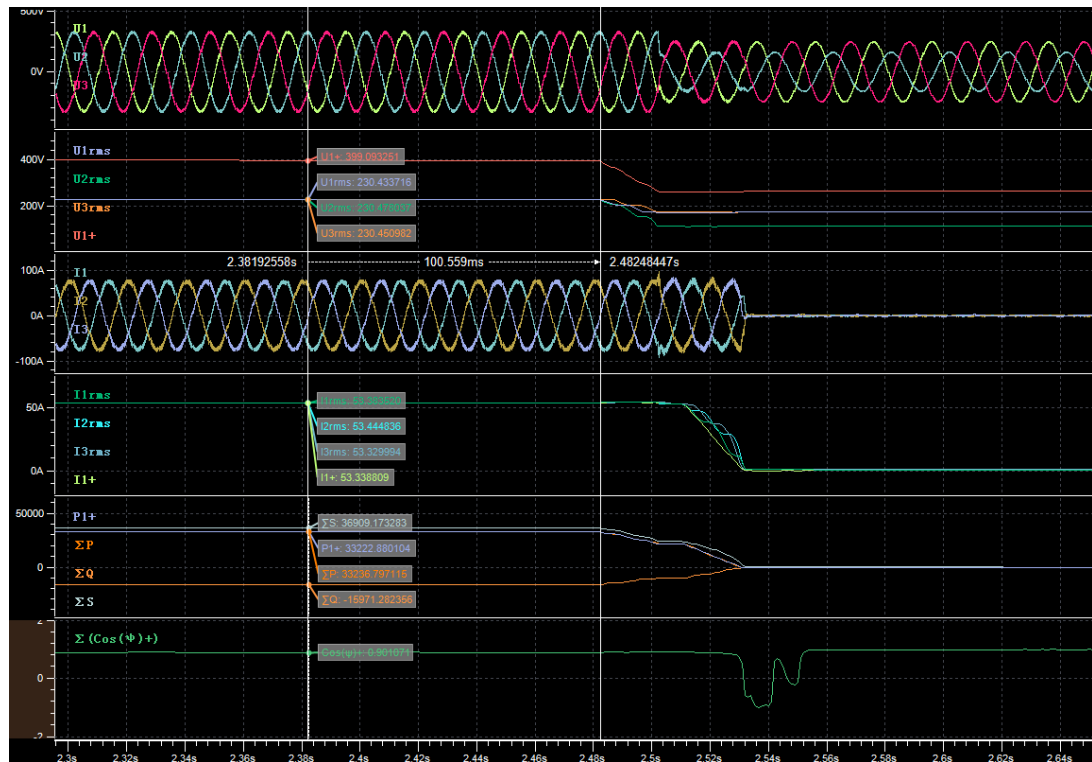

Before dip (t1-100ms)



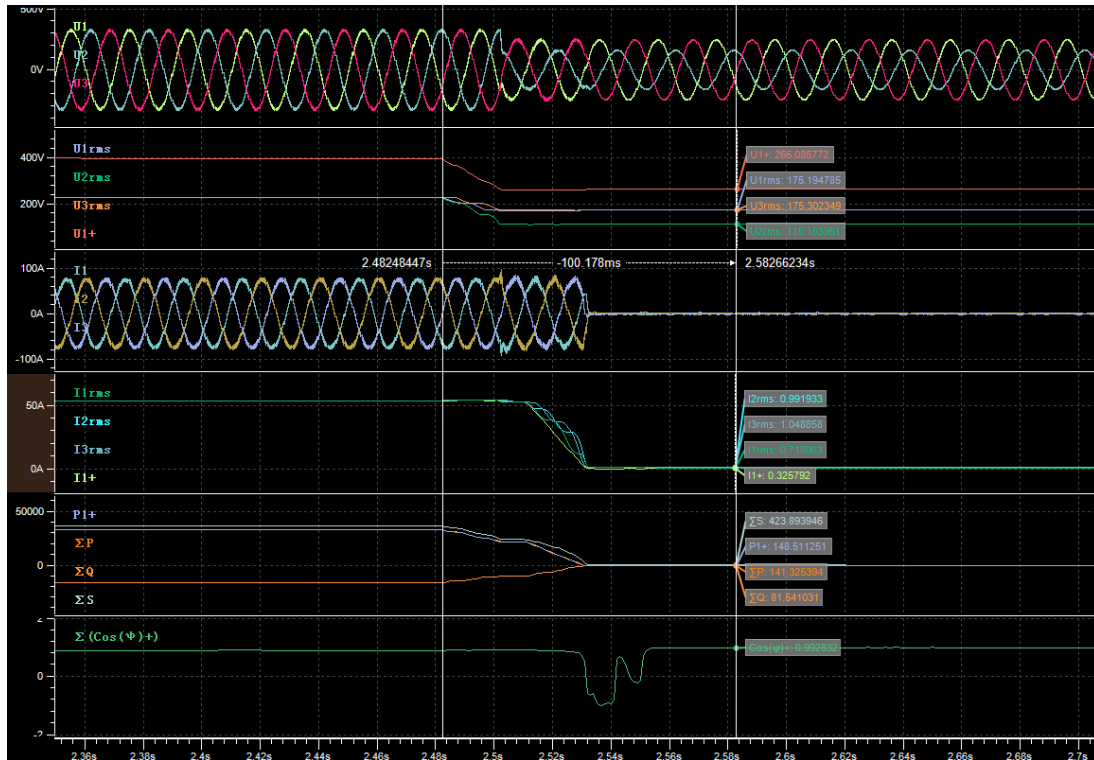
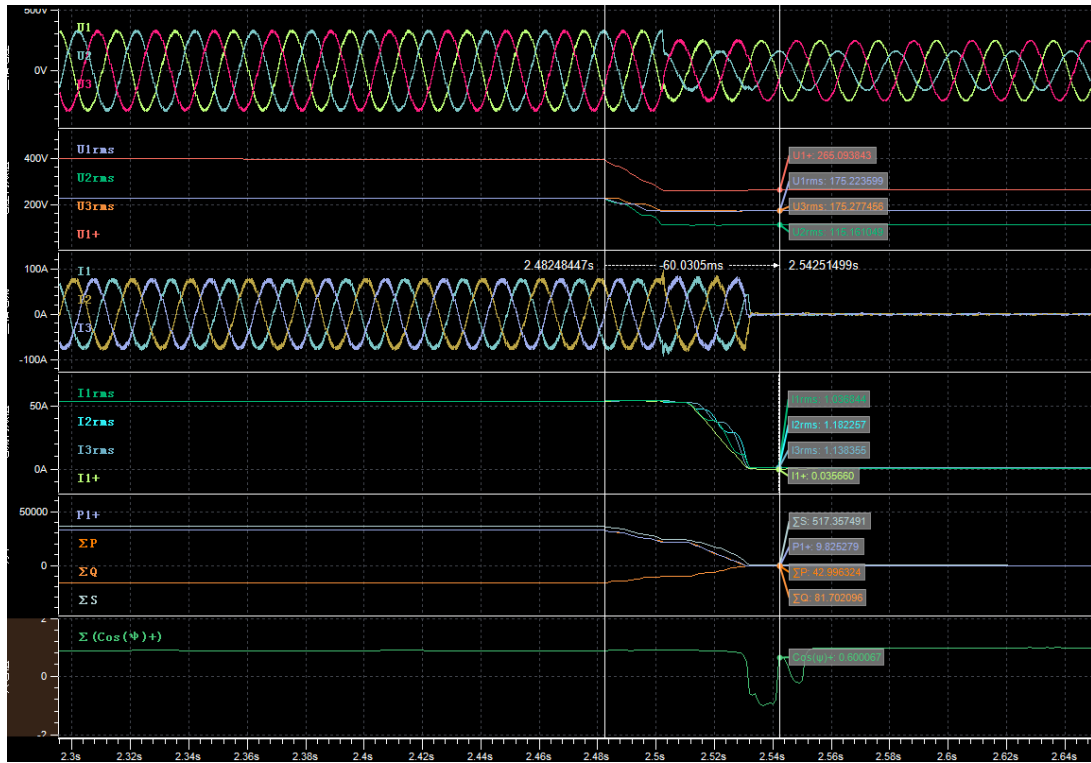

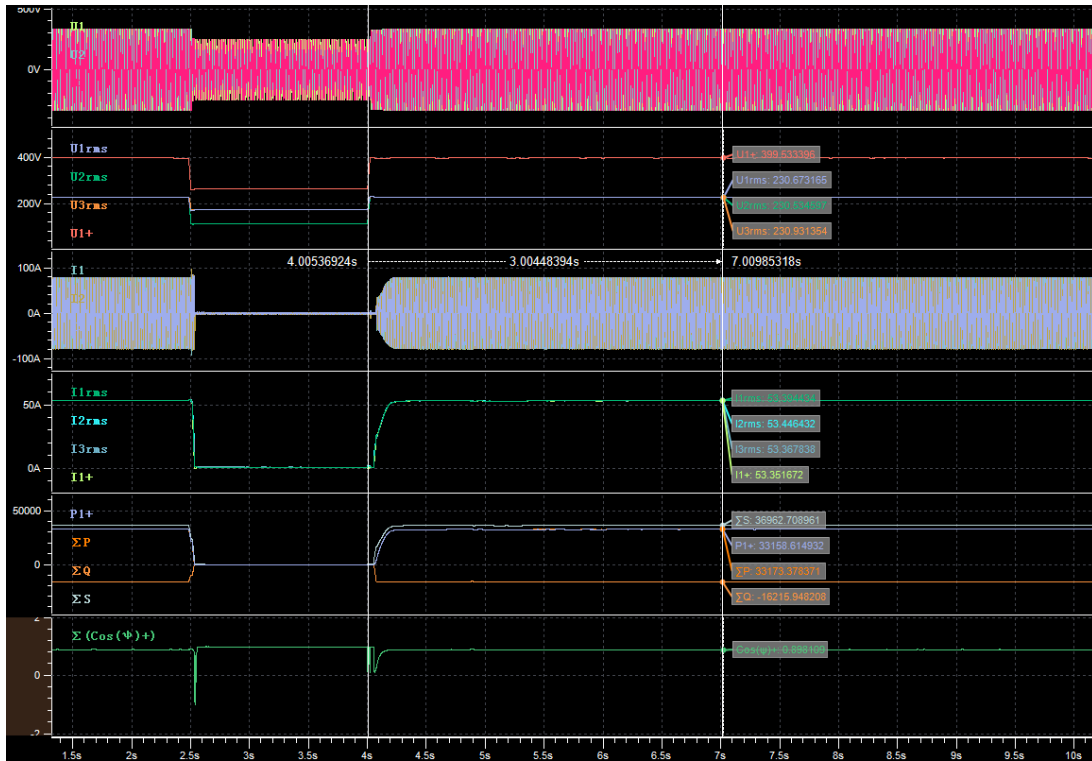

After dip (t2+3s)

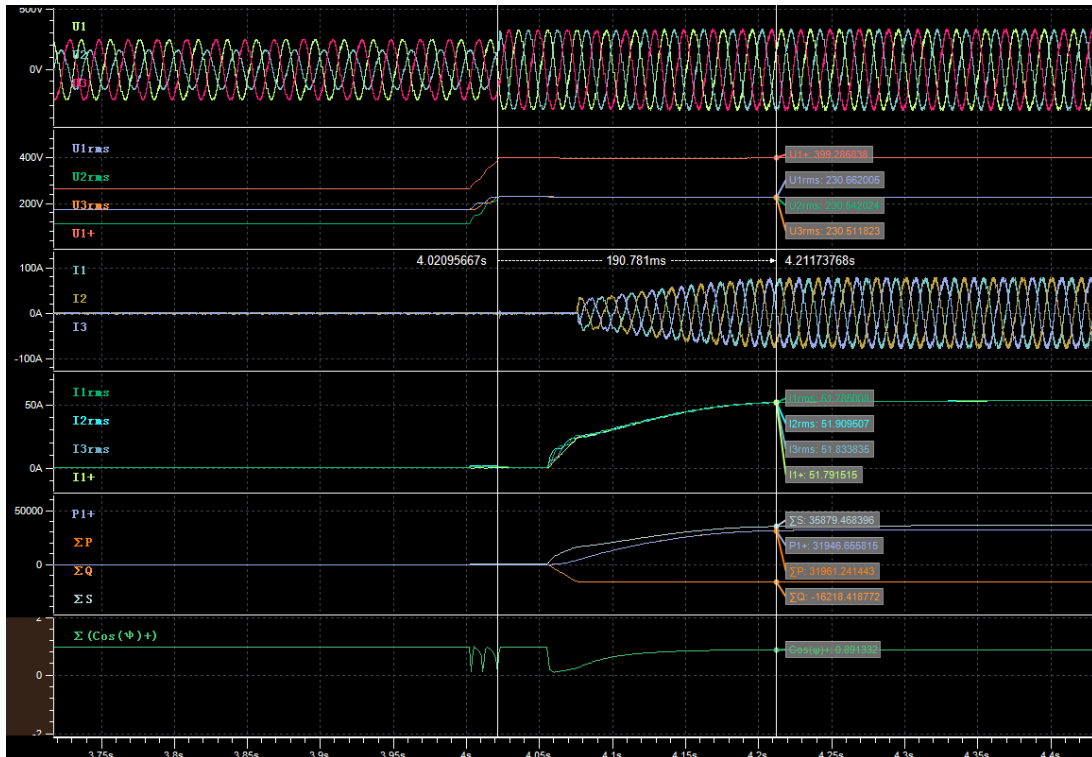

Recovery time

Graph of Test number 4.3

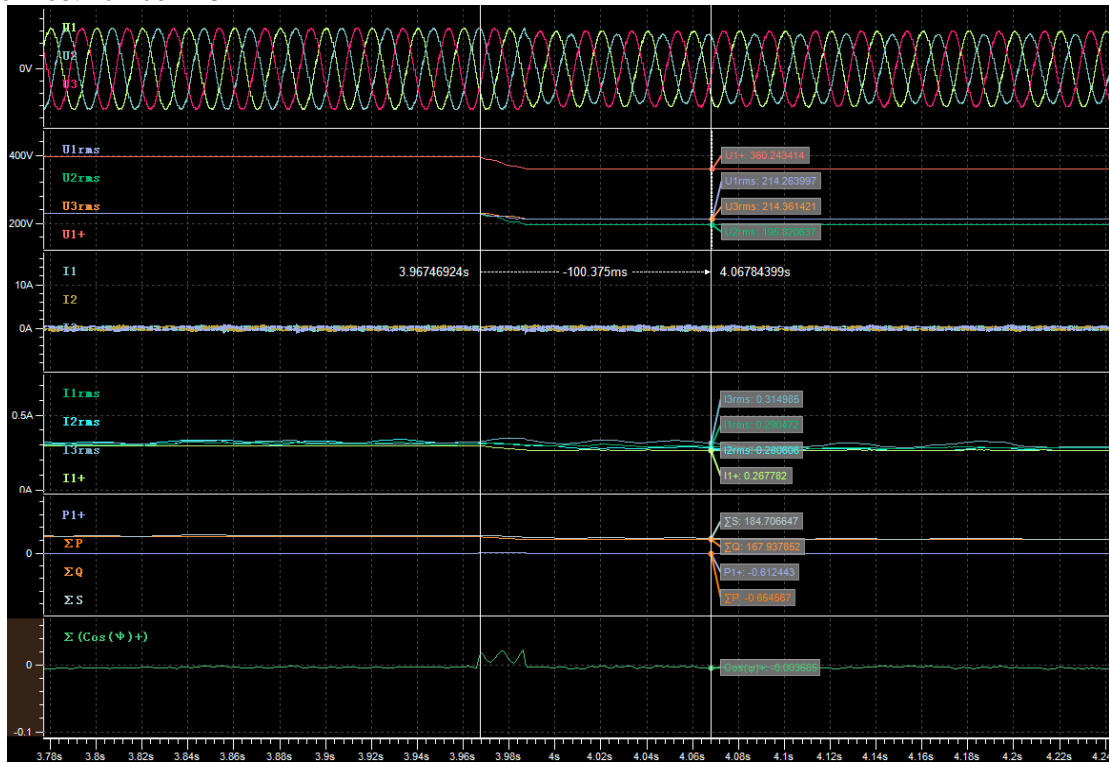

Empty load

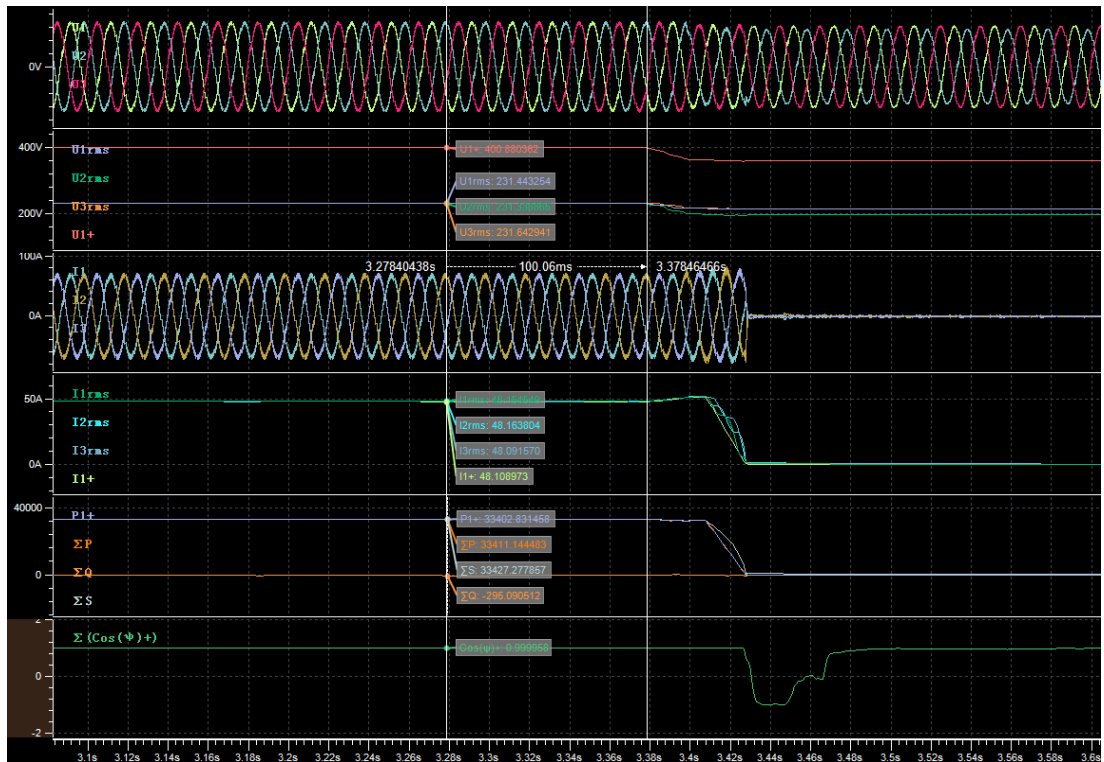

Before dip (t1-100ms)

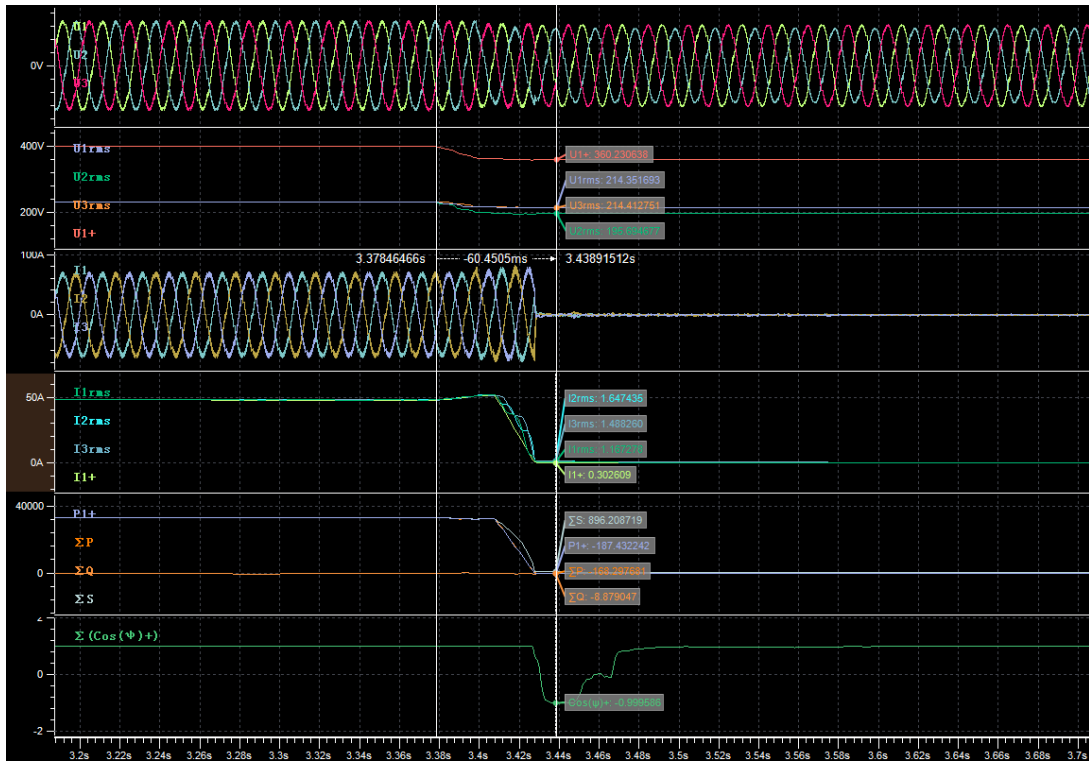

During dip (t1+60ms)

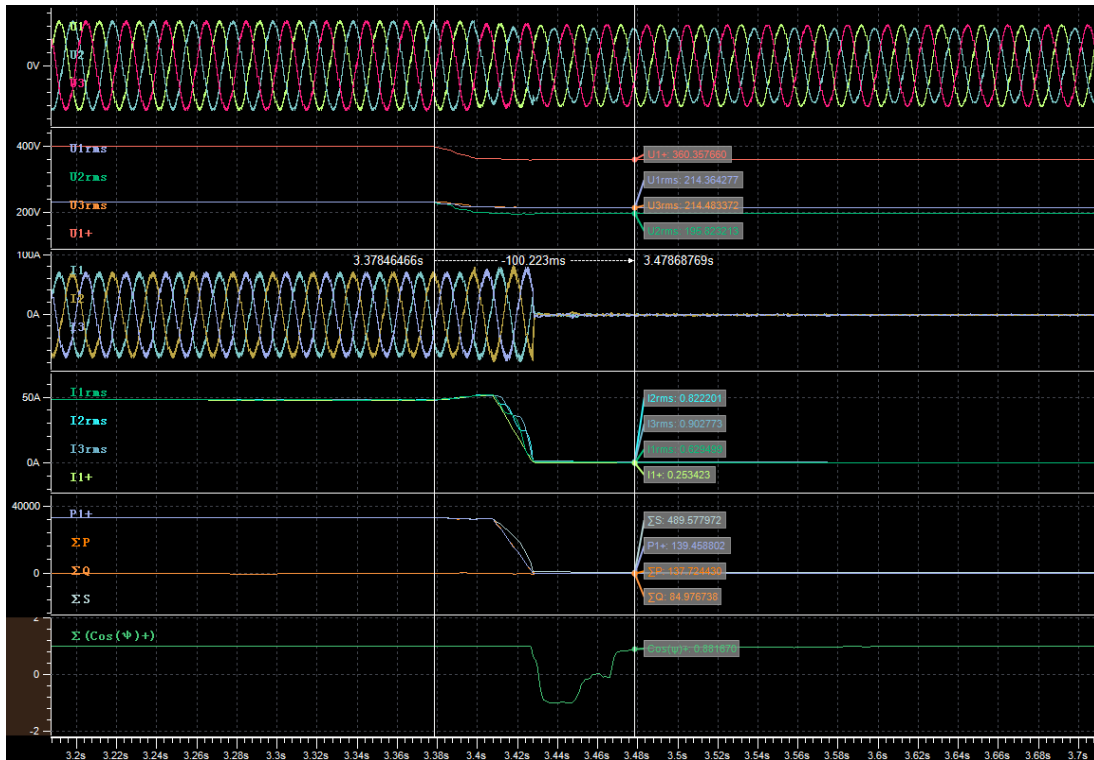

During dip (t1+100ms)

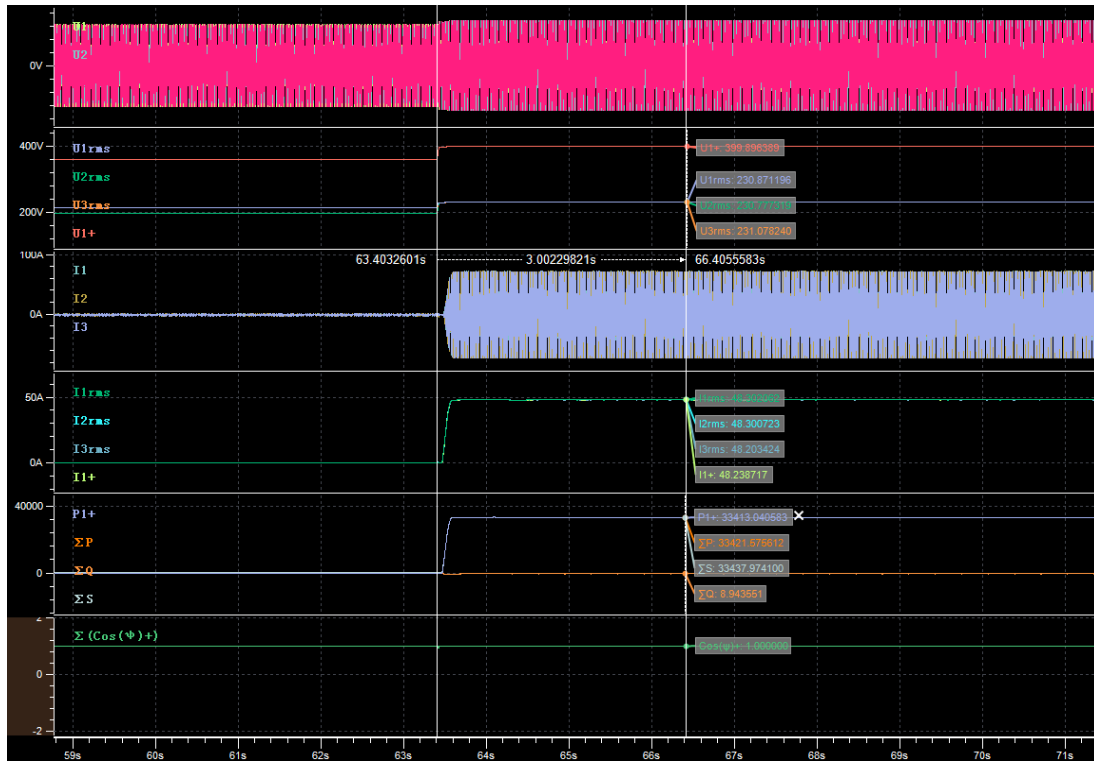

After dip (t2+3s)

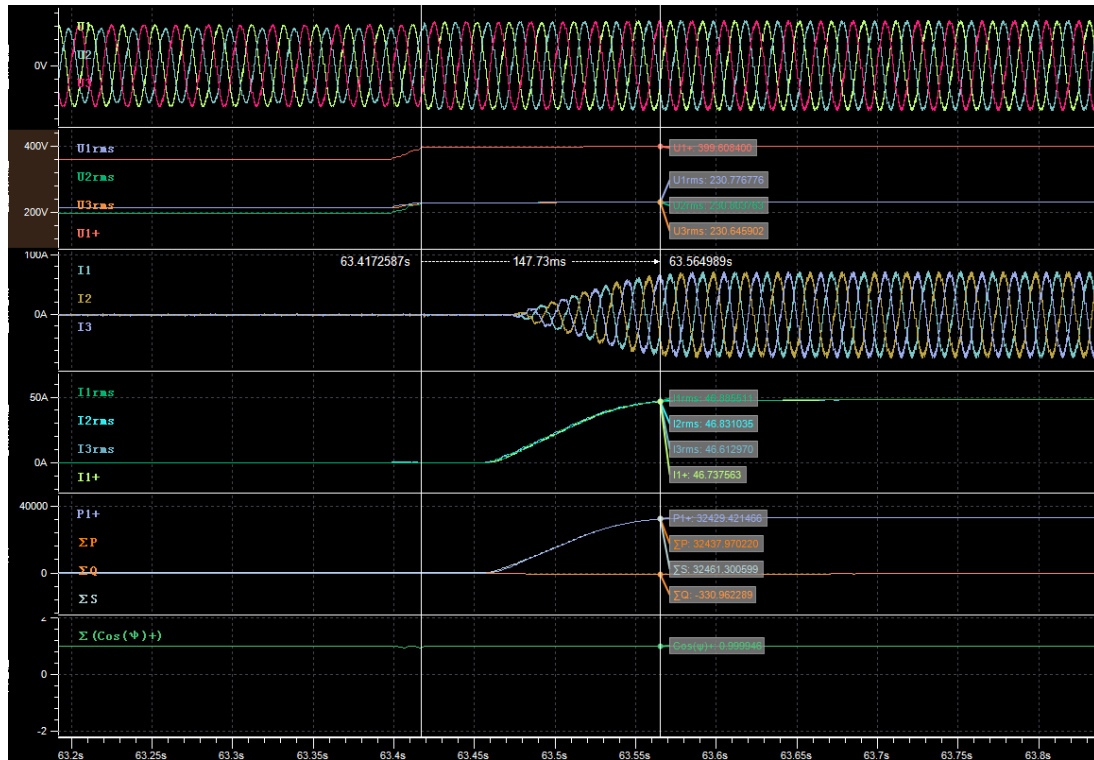

Recovery time

Verification of dynamic network support								P	
Short-circuited power at generator terminal [VA]			60K						
NS protection settings			See table 5.5 for detail.						
	No.	Parameter	Phase ref.	Time ref.	unit	Result			
General Info.	0	Test number	--	--	--	5.3	6.3	7.3	1.4
	1	Date	--	--	dd.mm.yyyy	20-April-2020 to 20-May-2020			
	2	Time (start of test)	--	--	hh:mm:ss.f	See graph			
	3	Fault type (phase)	--	--		D1	D1	D1	D1
	4	Setting voltage depth	Line to line	--	p.u.	1.25	1.20	1.15	0.15
	5	Setting dip duration		--	ms	100	5000	60000	150
	6	Point of fault entry	Total	--	ms	20ms			
	7	Point of fault clearance	Total	--	ms	20ms			
	8	Fault duration in empty load test	Total	--	ms	101.28	5015.5	60021	159.53
	9	Voltage depth/height in empty load test	Total	t1+100ms to t2 and t1-10s to t1	p.u.	1.082	1.062	1.042	0.622
10	Positive sequence					1.124	1.098	1.073	0.429
Before dip <t1	11	Voltage	Line to neutral	t1-10s to t1	p.u.	1.00	1.00	1.00	1.00
	12	Current	Positive sequence	t1-500ms to t1-100ms	p.u.	1.00	1.00	1.00	0.21
	13	Active power	Total	t1-10s to t1	p.u.	1.01	1.01	1.01	0.208
	14		Positive sequence			1.01	1.01	1.01	0.208
	15	Reactive power	Total	t1-10s to t1	p.u.	-0.008	-0.008	-0.009	-0.008
	16		Positive sequence			-0.008	-0.008	-0.009	-0.008
	17	Cos $\phi$	--	t1-10s to t1	--	0.9999	0.9999	0.9999	0.9992
During dip t1 to t2	18	Voltage	Phase 1	t1+100ms to t2-20ms	p.u.	1.083	1.063	1.043	0.621
			Phase 2			1.253	1.203	1.153	0.150
			Phase 3			1.064	1.053	1.043	0.622

	19	Line current	Phase 1	t1+60ms	p.u.	0.046	0.050	0.050	0.020	
	20		Phase 2			0.070	0.087	0.094	0.019	
	21		Phase 3			0.058	0.073	0.080	0.021	
		22	Line current	Phase 1	t1+100ms	p.u.	0.045	0.043	0.043	0.013
		23		Phase 2			0.052	0.050	0.048	0.018
		24		Phase 3			0.043	0.046	0.046	0.022
		25	Active power	Total	t1+100ms to t2-20ms	p.u.	0.009	0.008	0.007	0.002
26		Positive sequence		0.009			0.008	0.007	0.002	
After dip > t2	27	Voltage	Line to neutral	t2+3s to t2+10s	p.u.	1.00	1.00	1.00	1.00	
	28	Active power	Positive sequence.	t2+3s to t2+10s	p.u.	1.01	1.01	1.01	0.208	
			29			Total	1.01	1.01	1.01	0.208
	39	Active power rising time	Positive sequence	--	s	0.191	0.062	0.057	0.068	
	31	Reactive power	Positive sequence	t2+3s to t2+10s	p.u.	-0.008	-0.007	-0.007	-0.011	
			32			Total	-0.008	-0.007	-0.007	-0.011
	33	Reactive power rising time	Positive sequence	--	s	0.191	0.062	0.057	0.068	
	34	PGU does not disconnect from grid till 60s after fault	--	t2 to t2+60s	Yes / No	Yes				

Graph of Test number 5.3

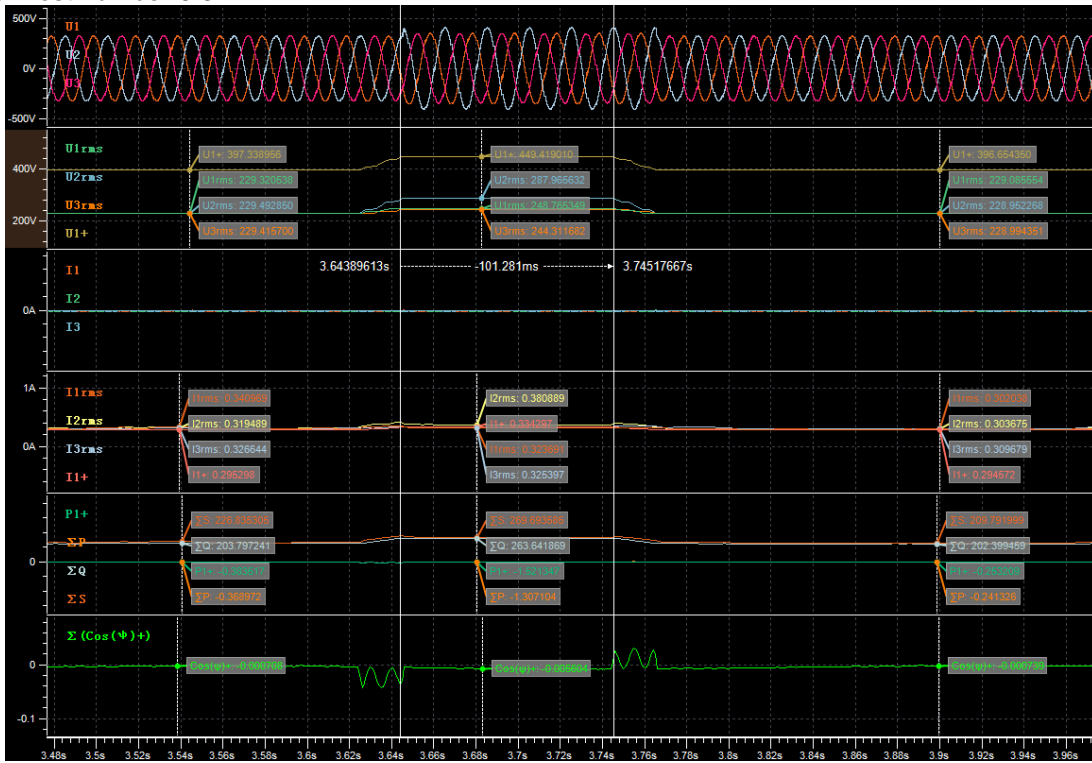

Empty load

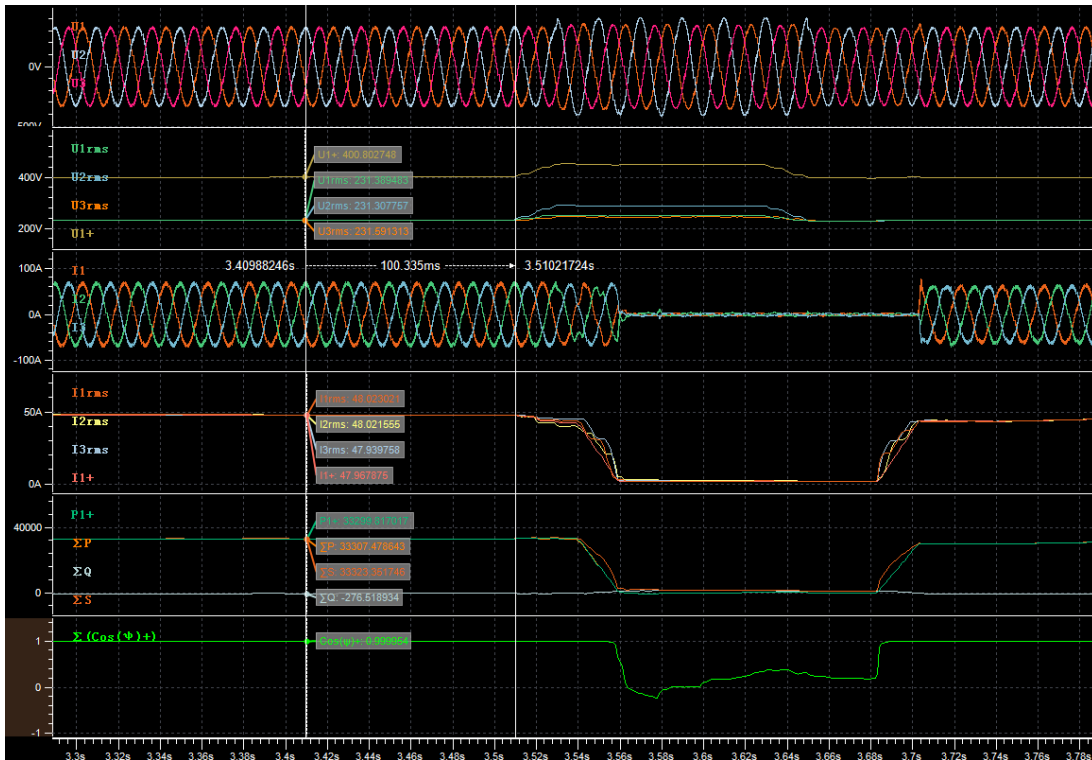

Before dip (t1-100ms)



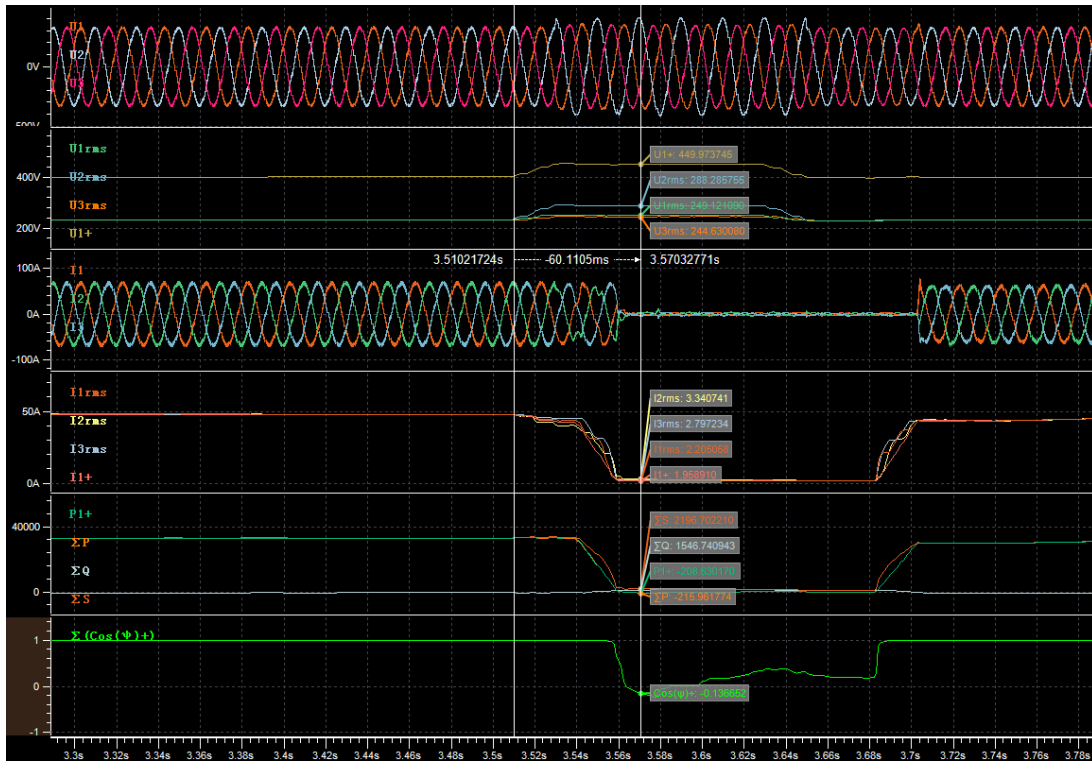

During dip (t1+60ms)

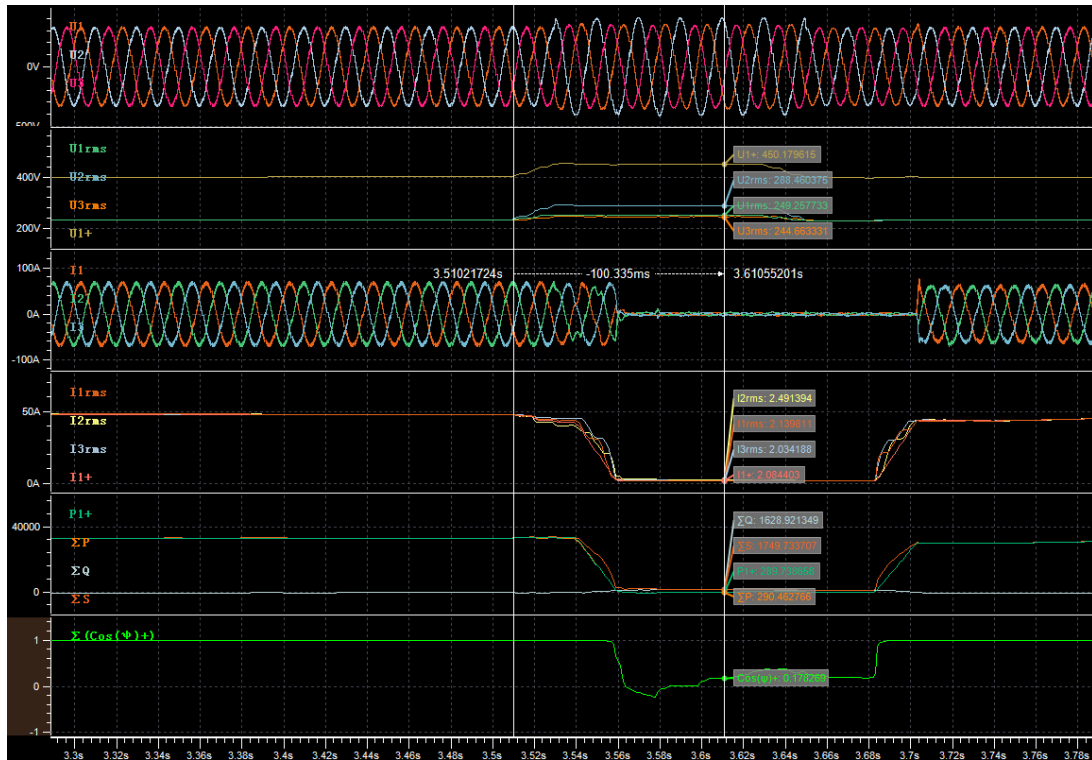

During dip (t1+100ms)

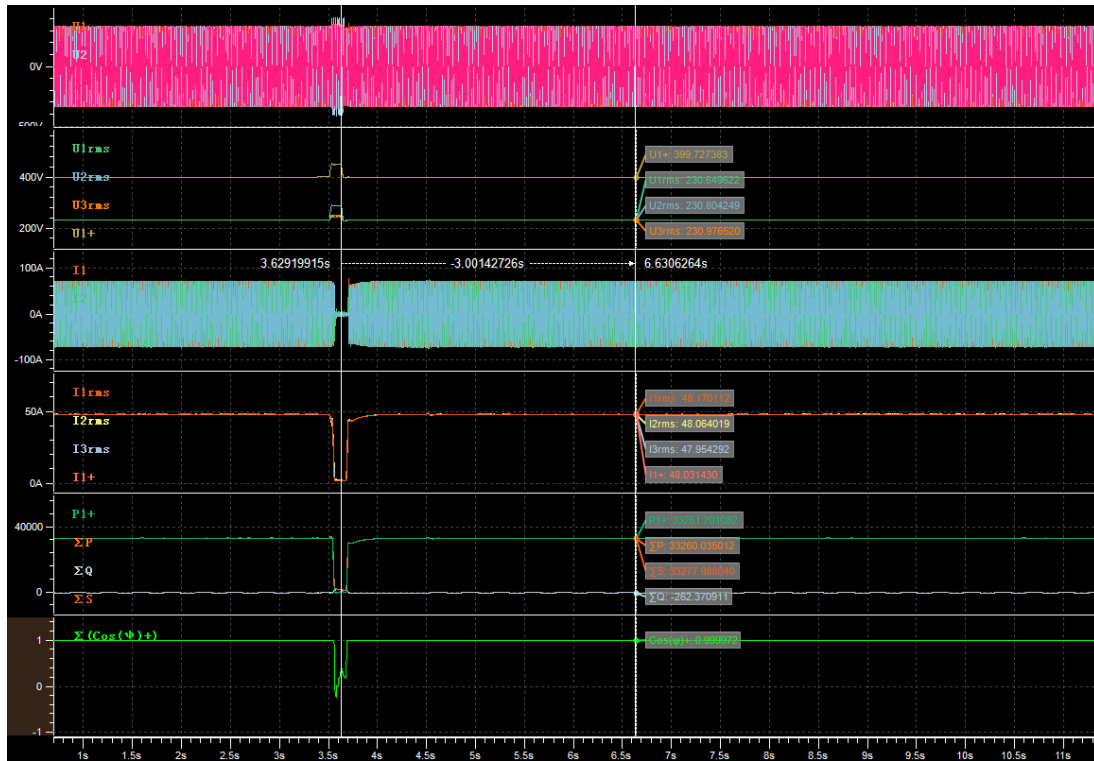

After dip (t2+3s)

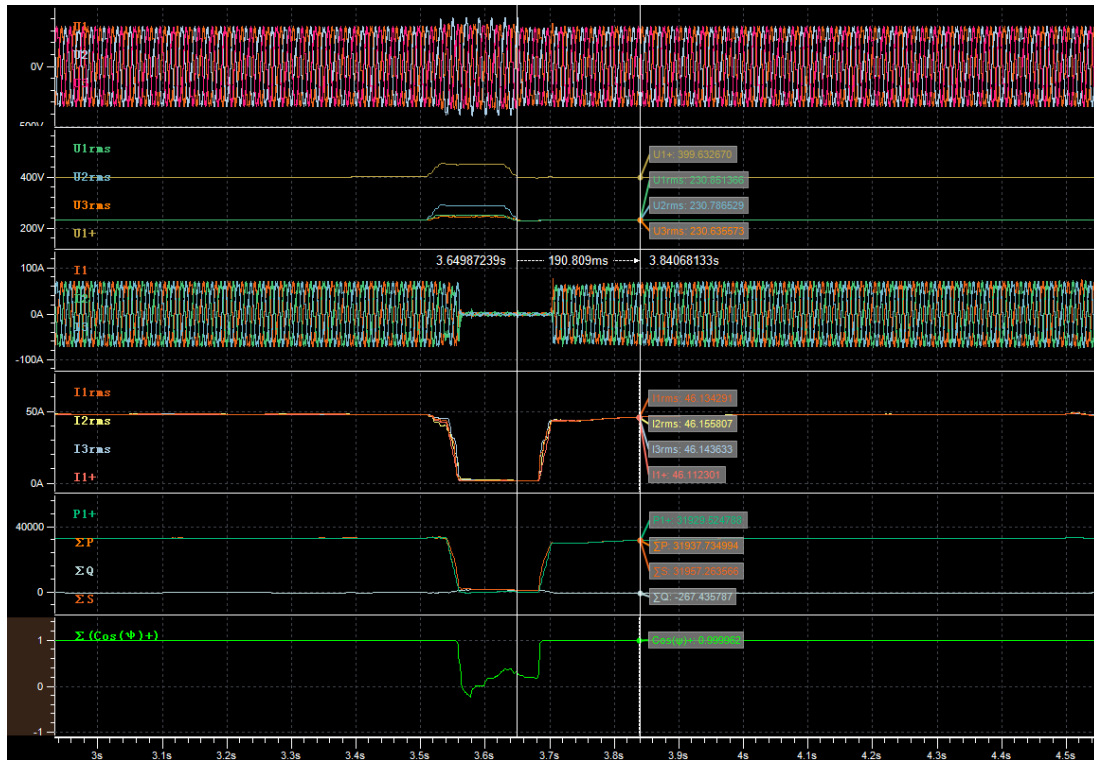

Recovery time

Graph of Test number 6.3

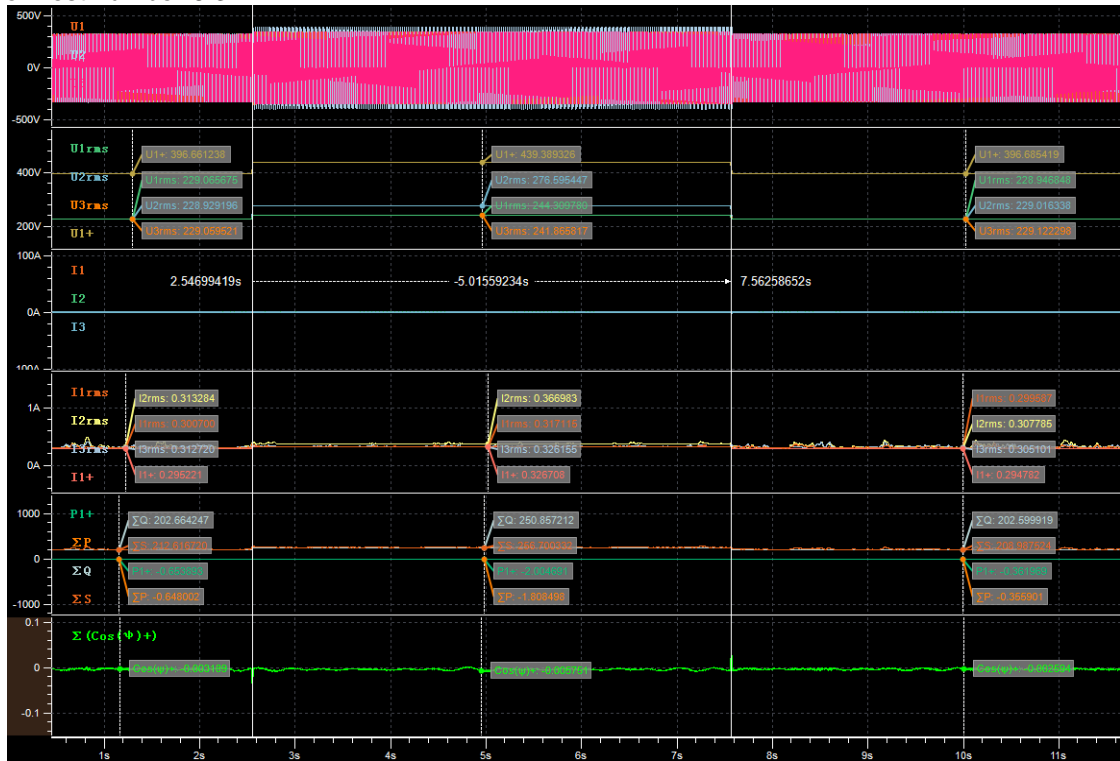

Empty load

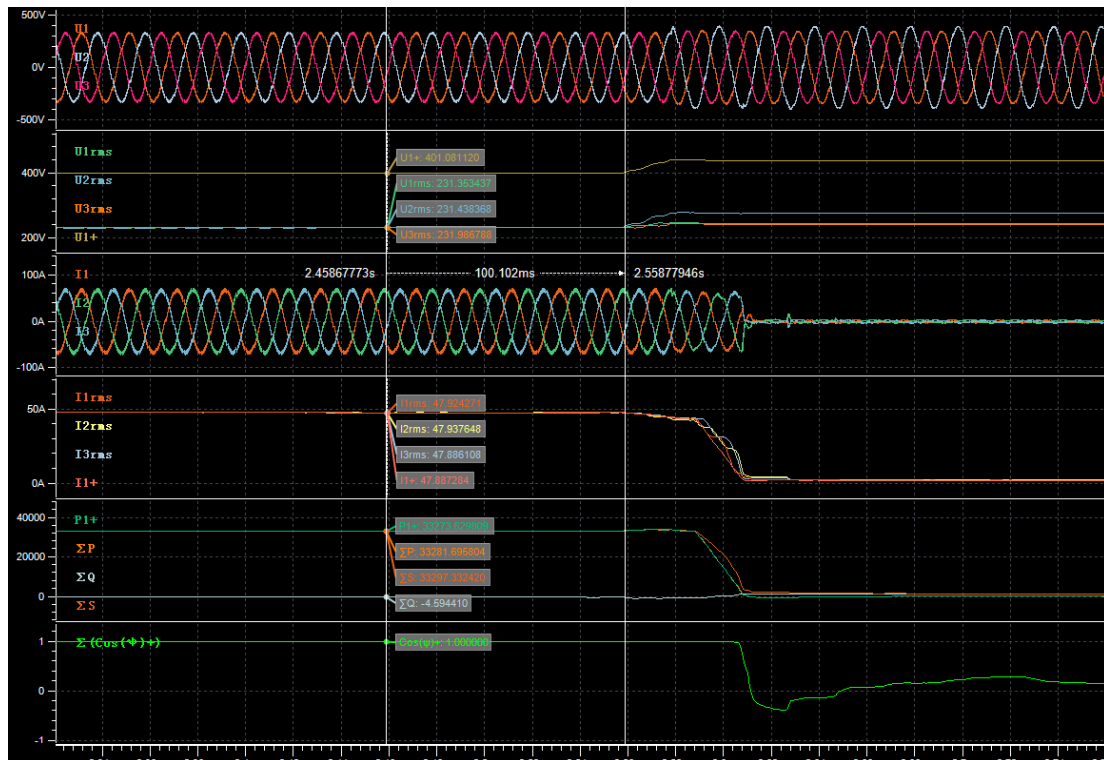

Before dip (t1-100ms)

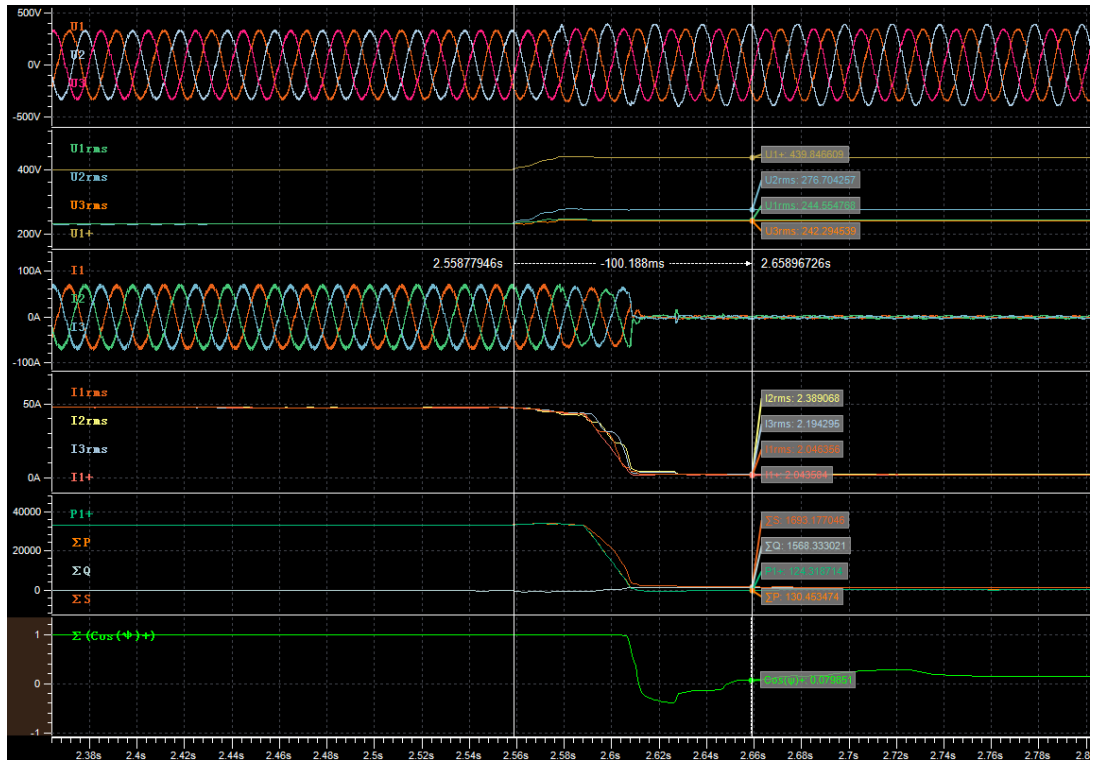
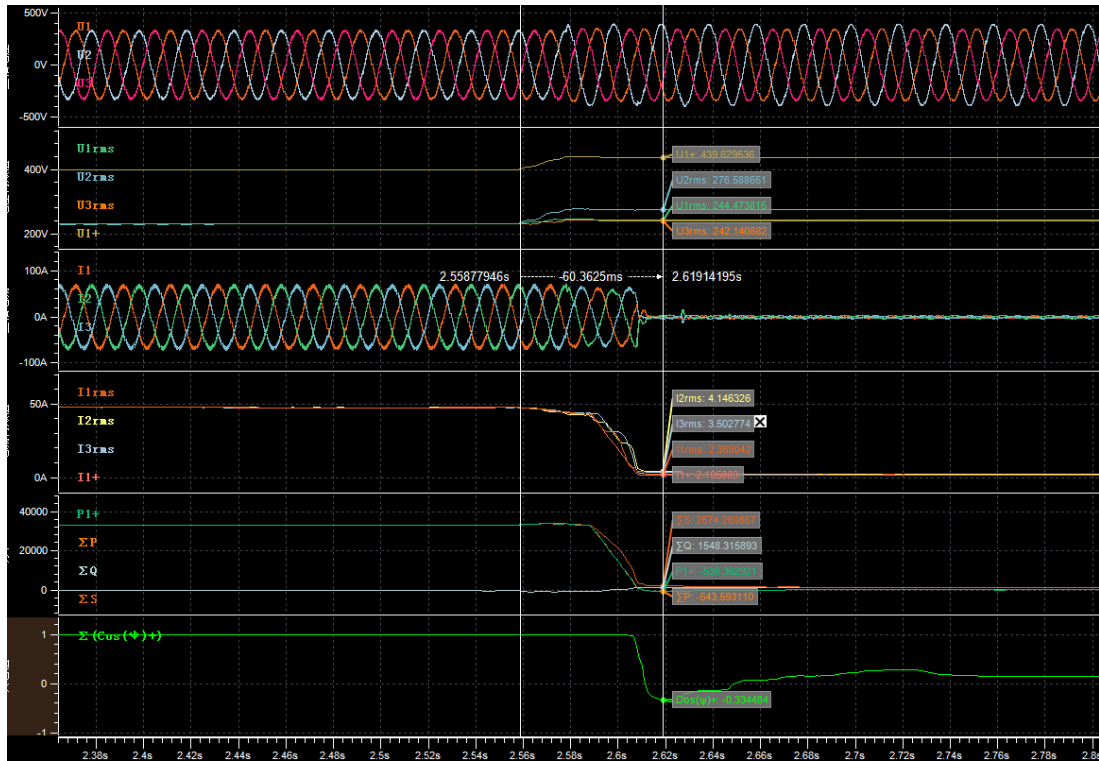

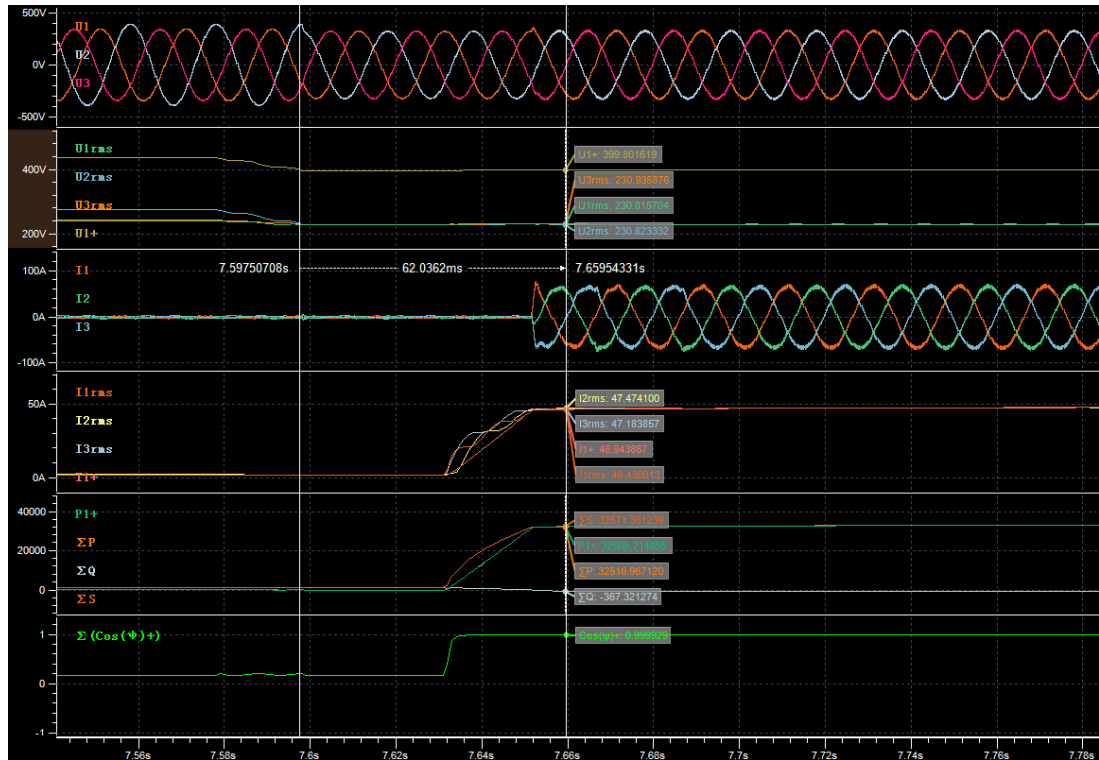
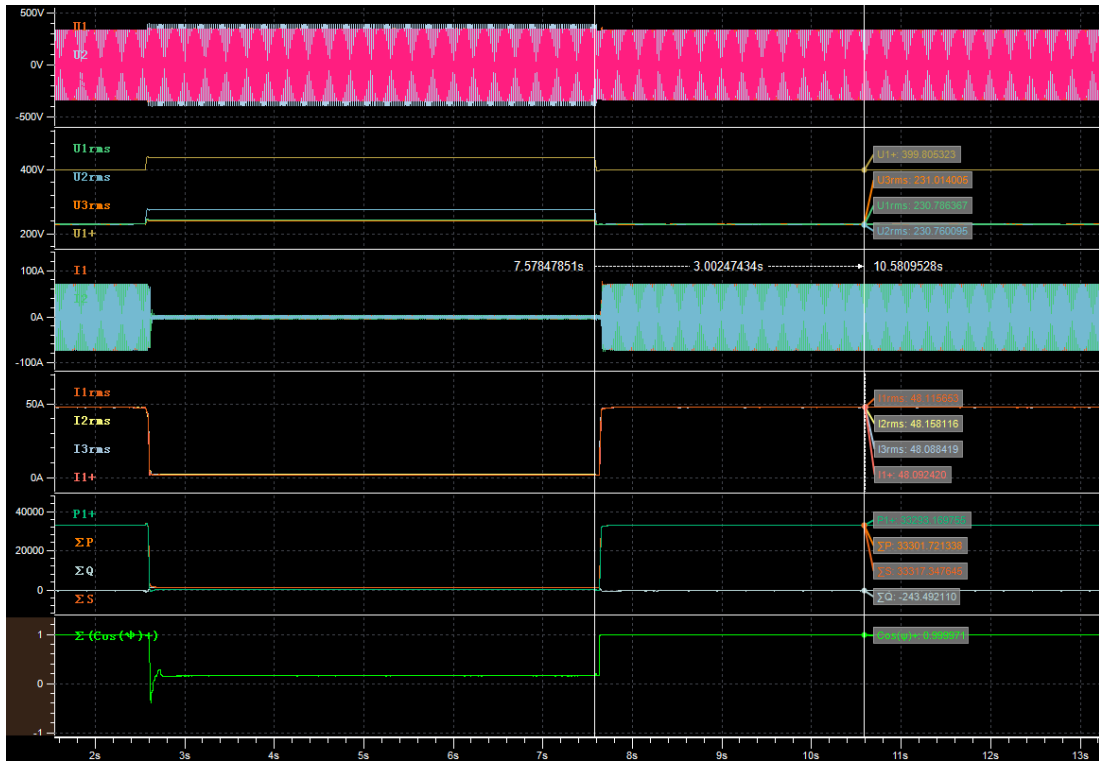

Graph of Test number 7.3

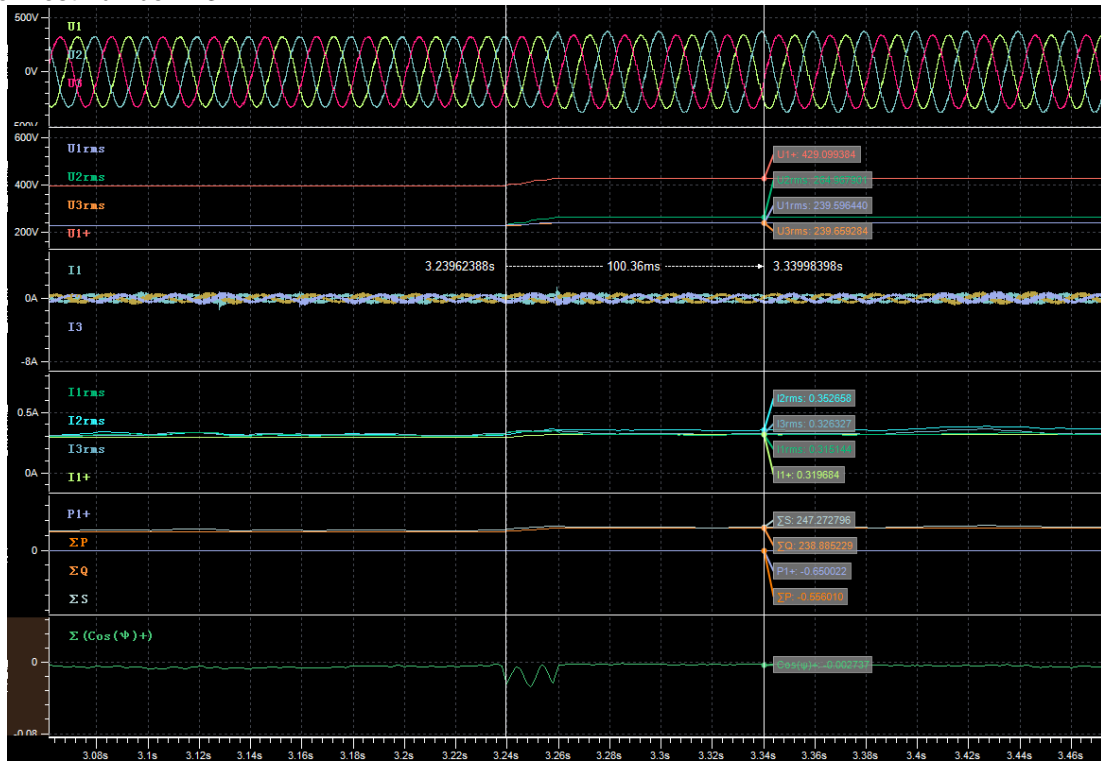

Empty load

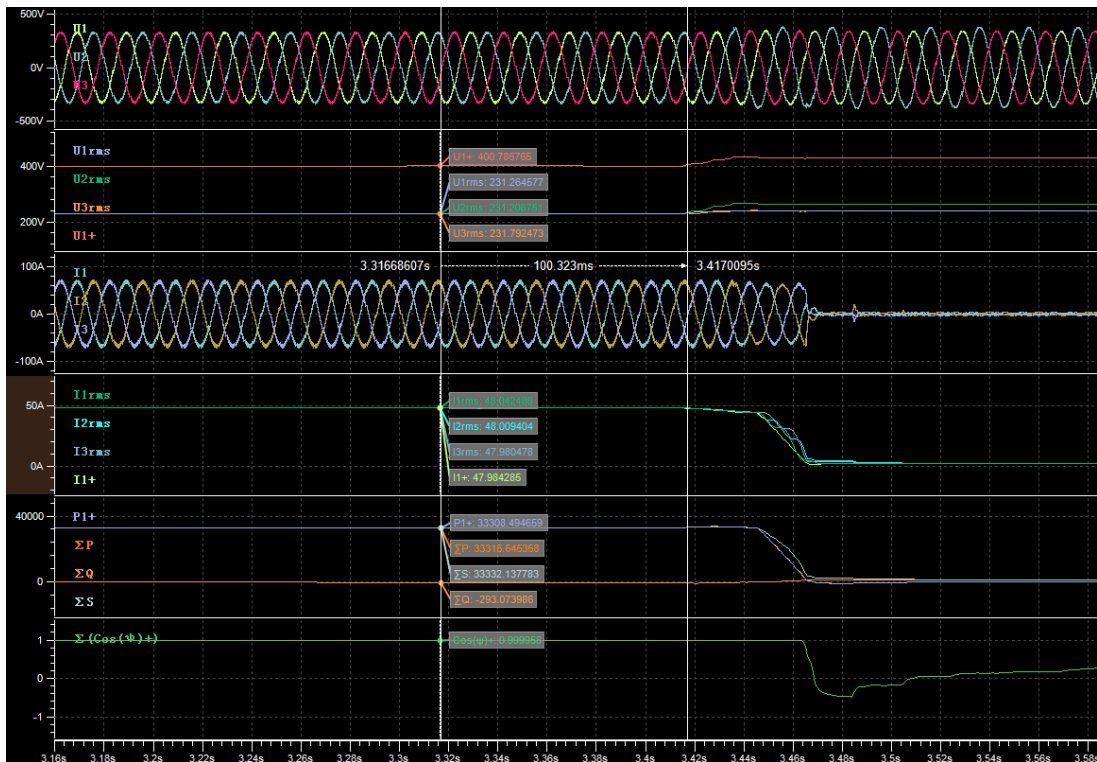

Before dip (t1-100ms)

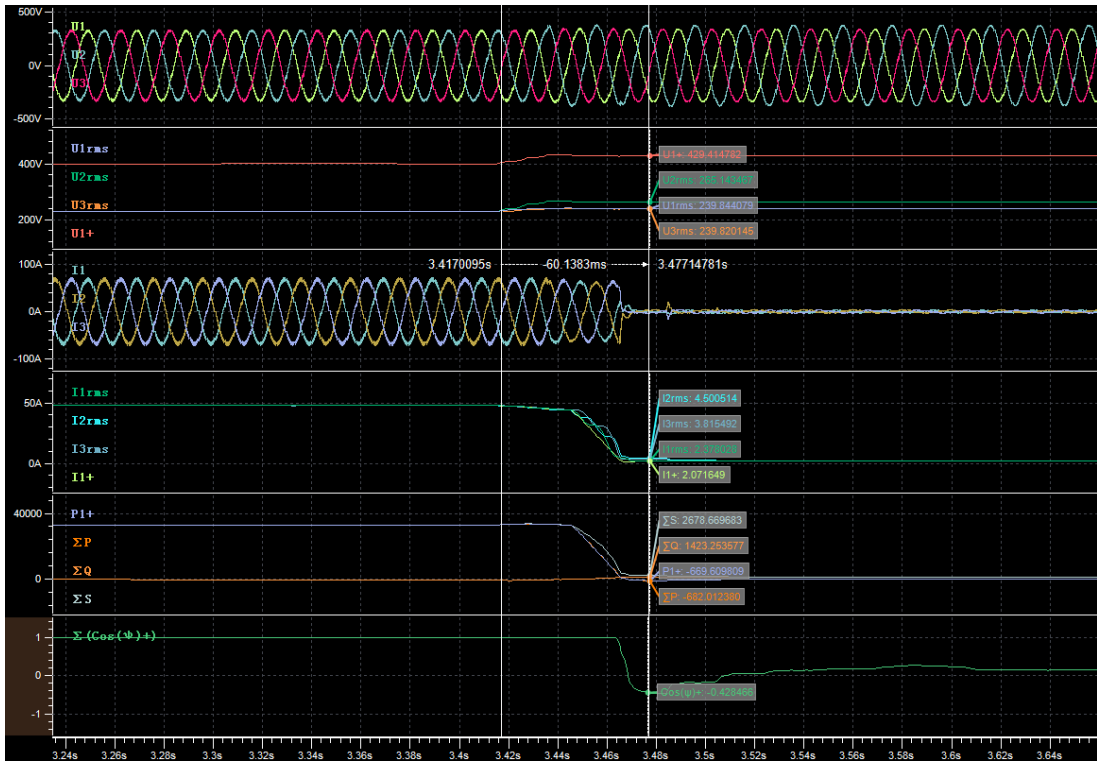

During dip (t1+60ms)

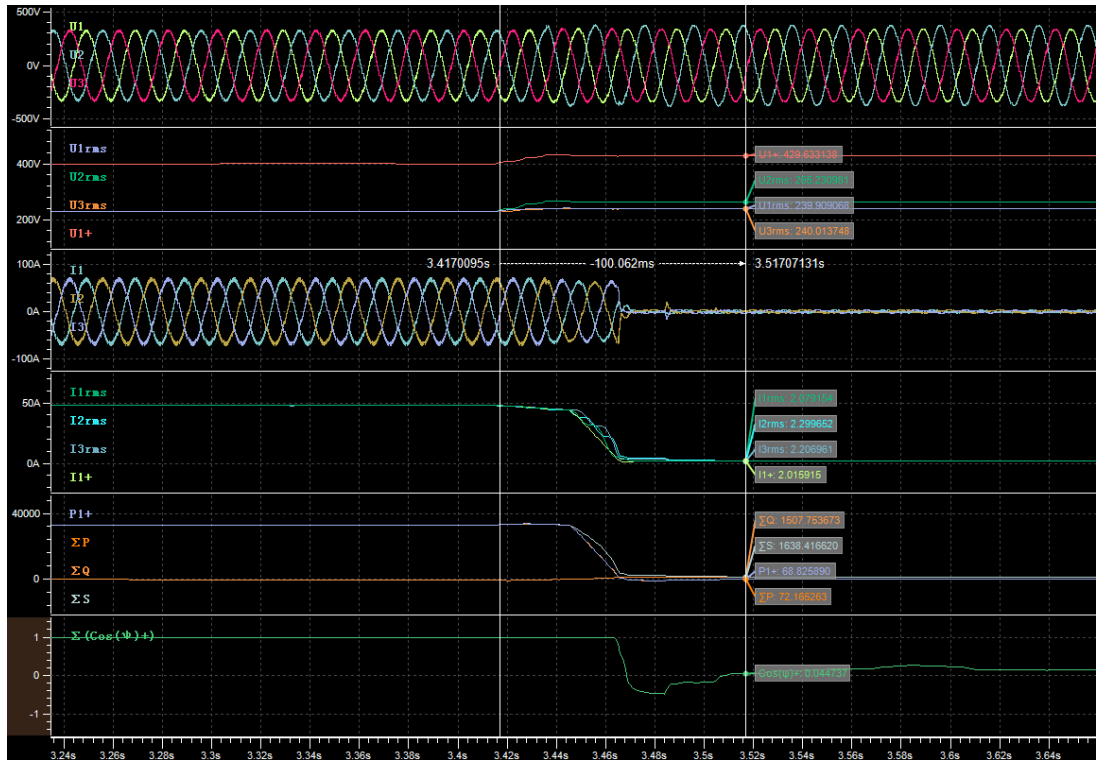

During dip (t1+100ms)

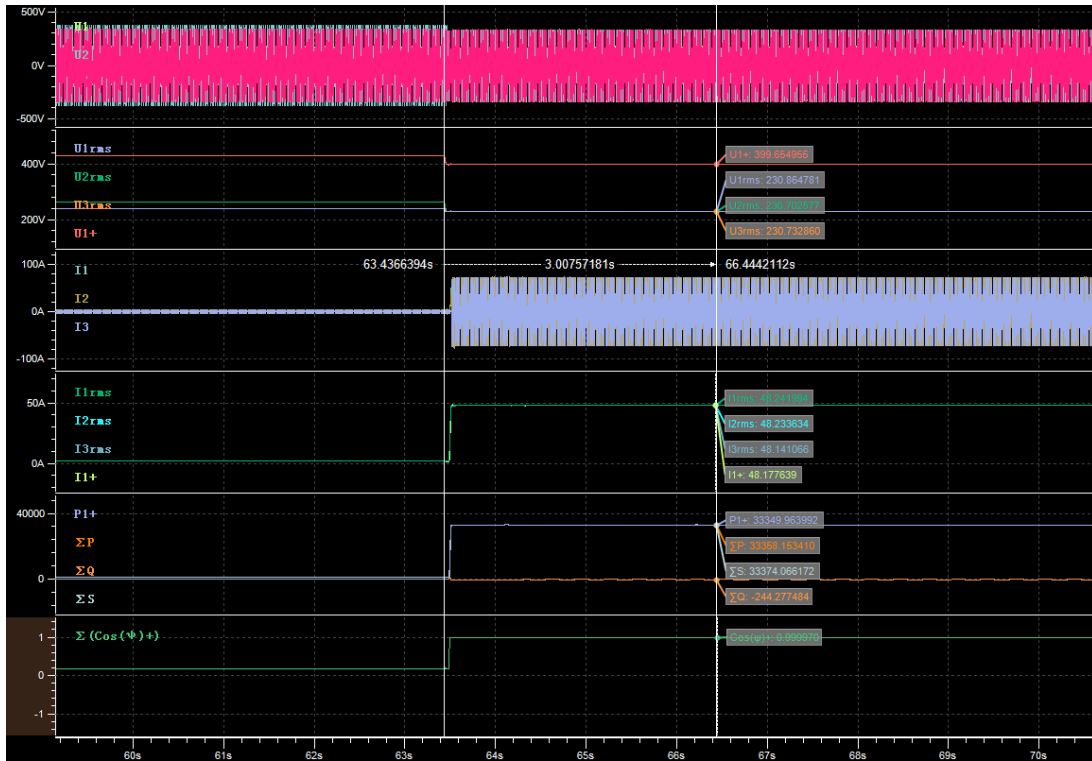

After dip (t2+3s)

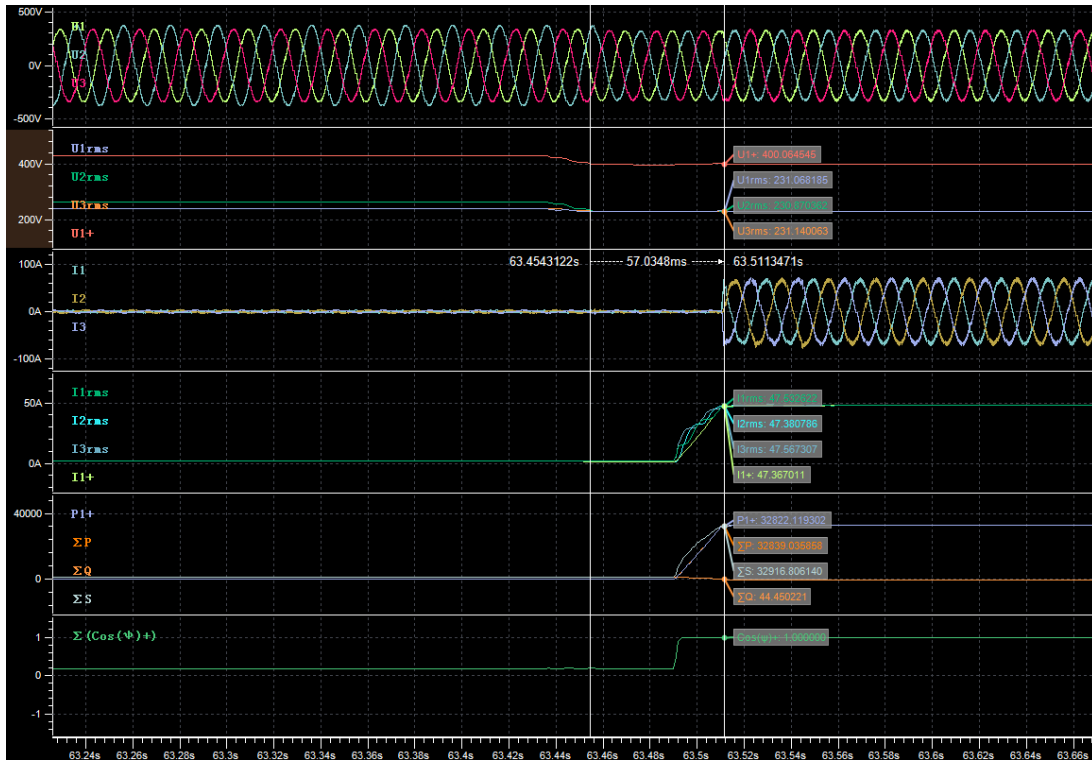

Recovery time



Graph of Test number 1.4

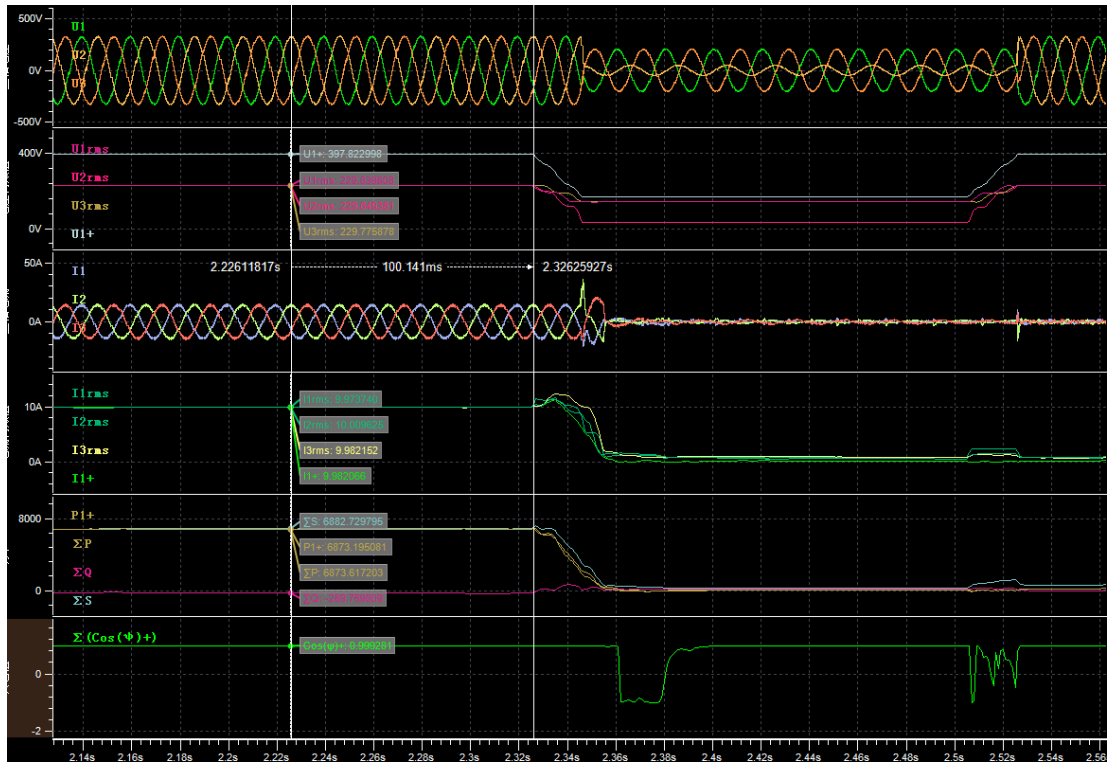

Before dip (t1-100ms)

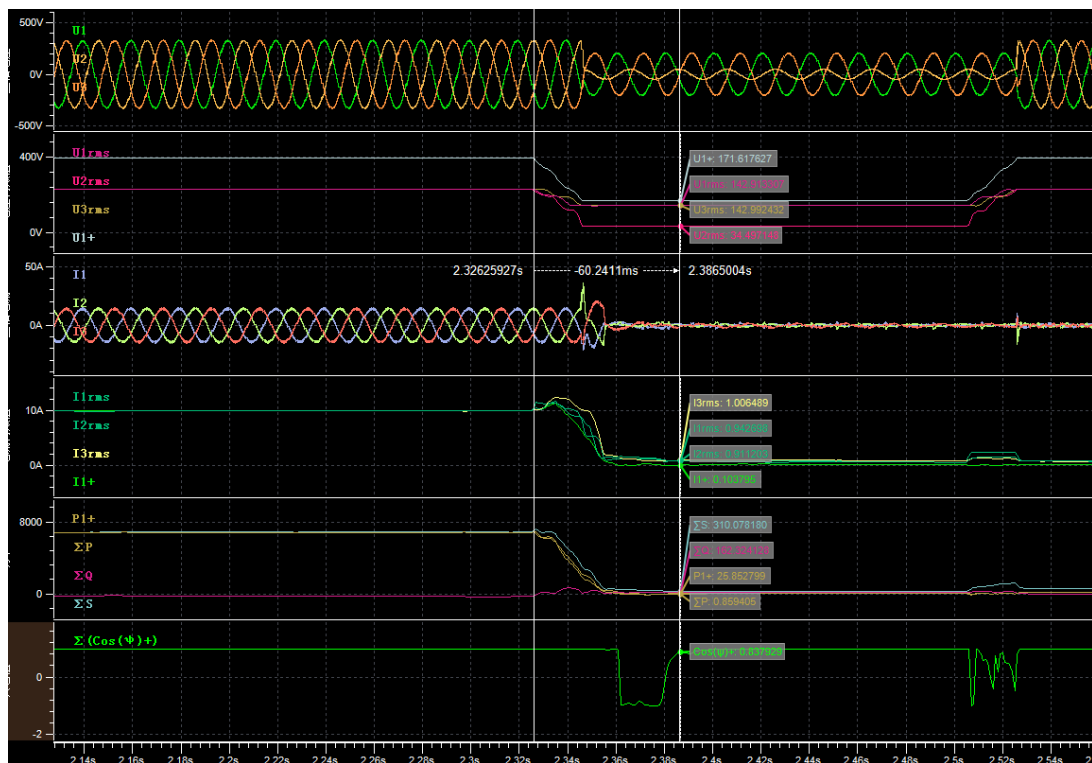

During dip (t1+60ms)

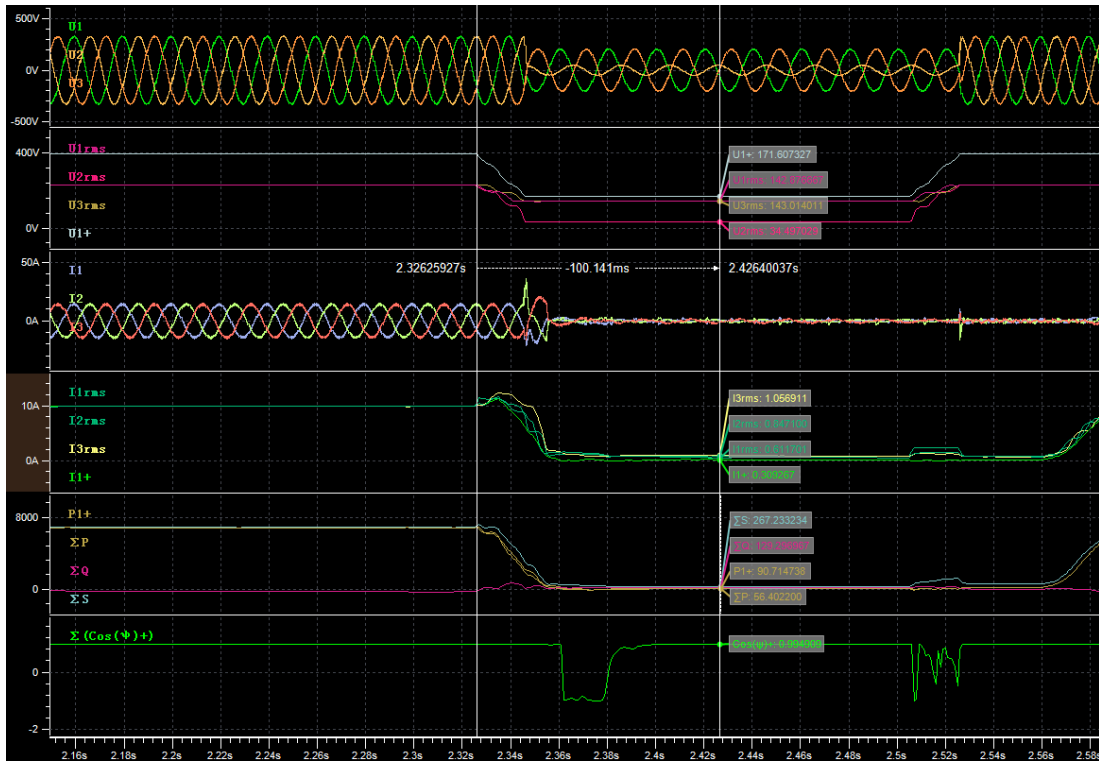

During dip (t1+100ms)

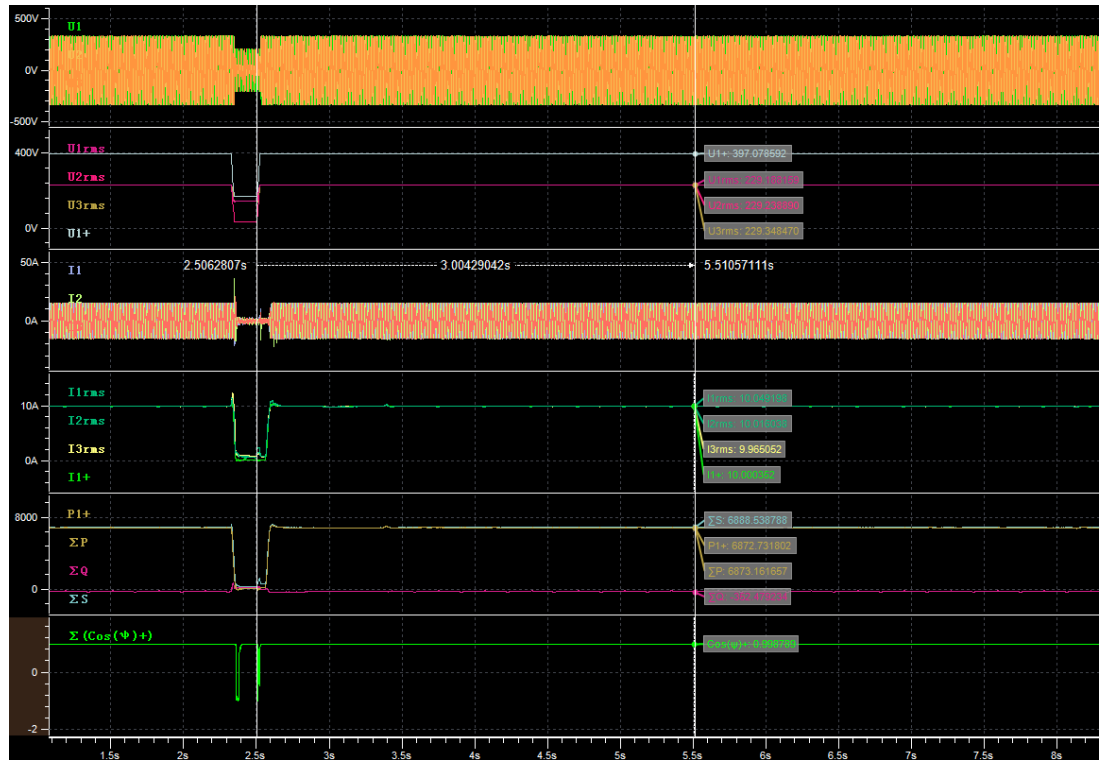

After dip (t2+3s)

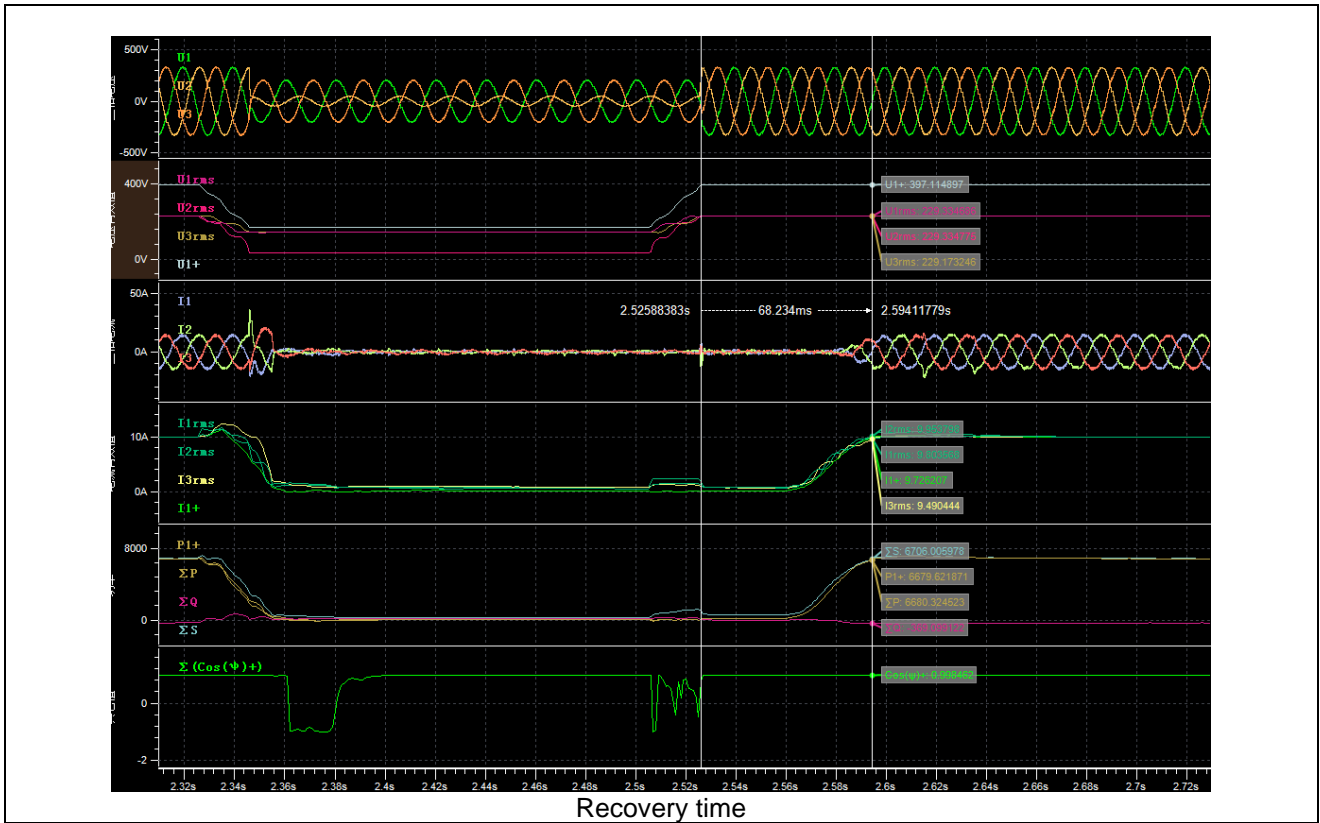

Verification of dynamic network support								P	
Short-circuited power at generator terminal [VA]			60K						
NS protection settings			See table 5.5 for detail.						
	No.	Parameter	Phase ref.	Time ref.	unit	Result			
General Info.	0	Test number	--	--	--	2.4	3.4	4.4	5.4
	1	Date	--	--	dd.mm.yyyy	20-April-2020 to 20-May-2020			
	2	Time (start of test)	--	--	hh:mm:ss.f	See graph			
	3	Fault type (phase)	--	--		D1	D1	D1	D1
	4	Setting voltage depth	Line to line	--	p.u.	0.50	0.50	0.85	1.25
	5	Setting dip duration		--	ms	1500	1500	60000	100
	6	Point of fault entry	Total	--	ms	20ms			
	7	Point of fault clearance	Total	--	ms	20ms			
	8	Fault duration in empty load test	Total	--	ms	1502.4	1502.2	60002	101.28
	9	Voltage depth/height in empty load test	Total	t1+100ms to t2 and t1-10s to t1	p.u.	0.761	0.761	0.932	1.082
10	Positive sequence					0.501	0.501	0.851	1.252
					0.762	0.761	0.934	1.062	
Before dip <t1	11	Voltage	Line to neutral	t1-10s to t1	p.u.	1.00	1.00	1.00	1.00
	12	Current	Positive sequence	t1-500ms to t1-100ms	p.u.	0.53	0.53	0.21	0.21
	13	Active power	Total	t1-10s to t1	p.u.	0.203	0.201	0.208	0.206
	14		Positive sequence			0.203	0.201	0.208	0.206
	15	Reactive power	Total	t1-10s to t1	p.u.	0.498	-0.488	-0.008	-0.010
	16		Positive sequence			0.498	-0.488	-0.008	-0.010
	17	Cos $\phi$	--	t1-10s to t1	--	0.3779	0.3807	0.9992	0.9989
During	18	Voltage	Phase 1	t1+100ms	p.u.	0.761	0.762	0.932	1.083

dip t1 to t2			Phase 2	to t2-20ms		0.500	0.500	0.851	1.252
			Phase 3			0.762	0.762	0.931	1.063
	19	Line current	Phase 1	t1+60ms	p.u.	0.021	0.029	0.028	0.043
	20		Phase 2			0.040	0.027	0.034	0.058
	21		Phase 3			0.024	0.025	0.029	0.049
	22	Line current	Phase 1	t1+100ms	p.u.	0.015	0.015	0.012	0.044
	23		Phase 2			0.019	0.019	0.015	0.052
	24		Phase 3			0.021	0.022	0.016	0.044
	25	Active power	Total	t1+100ms to t2-20ms	p.u.	0.003	0.003	0.002	0.002
26	Positive sequence		0.003			0.003	0.002	0.001	
After dip > t2	27	Voltage	Line to neutral	t2+3s to t2+10s	p.u.	1.00	1.00	1.00	1.00
	28	Active power	Positive sequence.	t2+3s to t2+10s	p.u.	0.203	0.202	0.208	0.206
	29		Total			0.203	0.202	0.208	0.206
	39	Active power rising time	Positive sequence	--	s	0.070	0.065	0.069	0.058
	31	Reactive power	Positive sequence	t2+3s to t2+10s	p.u.	0.484	-0.491	-0.007	-0.007
	32		Total			0.484	-0.491	-0.007	-0.007
	33	Reactive power rising time	Positive sequence	--	s	0.070	0.065	0.069	0.058
	34	PGU does not disconnect from grid till 60s after fault	--	t2 to t2+60s	Yes / No	Yes			

Graph of Test number 2.4

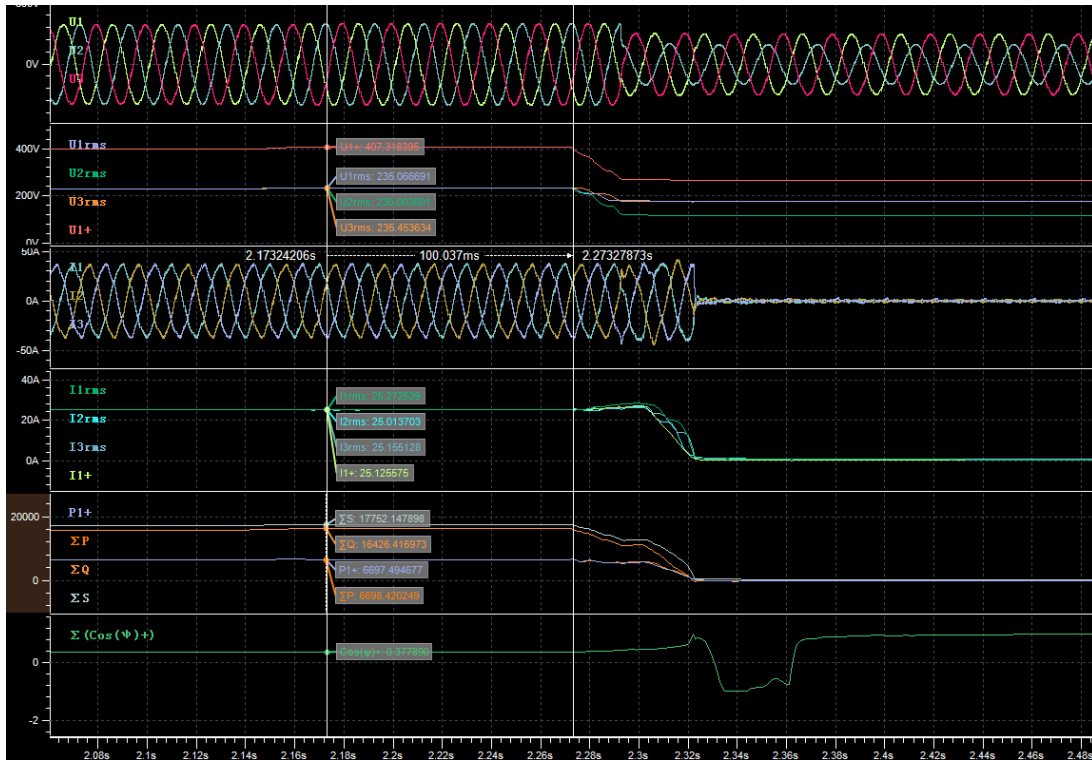

Before dip (t1-100ms)

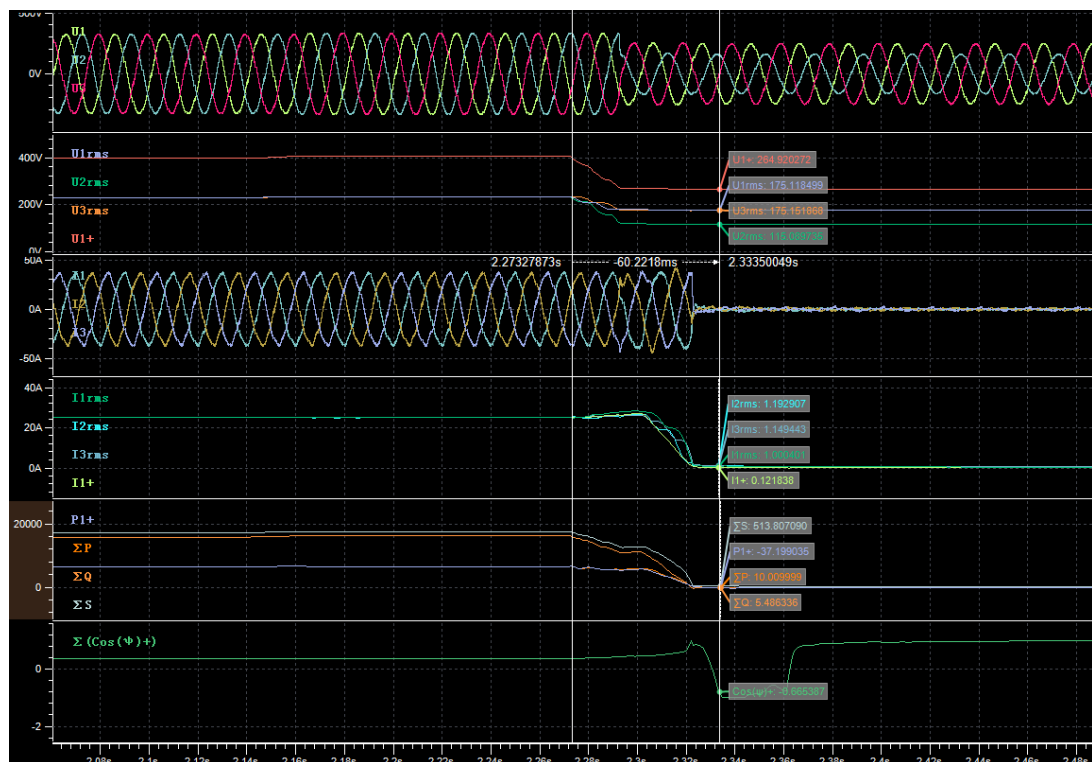

During dip (t1+60ms)

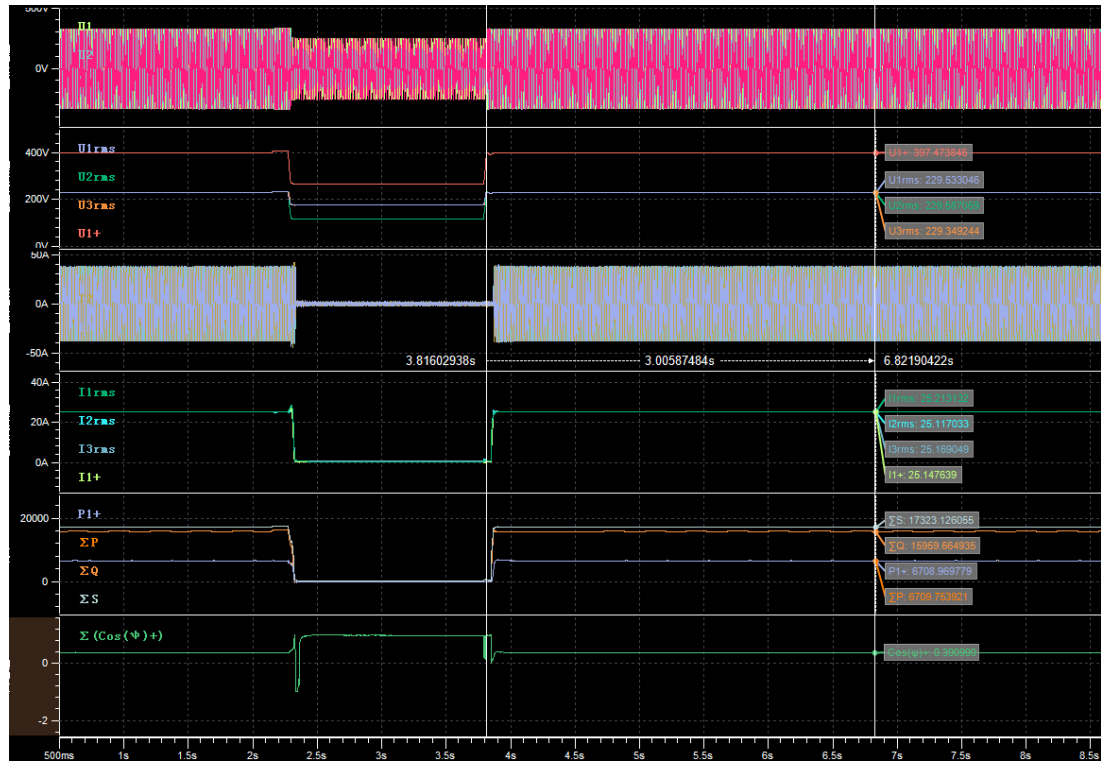
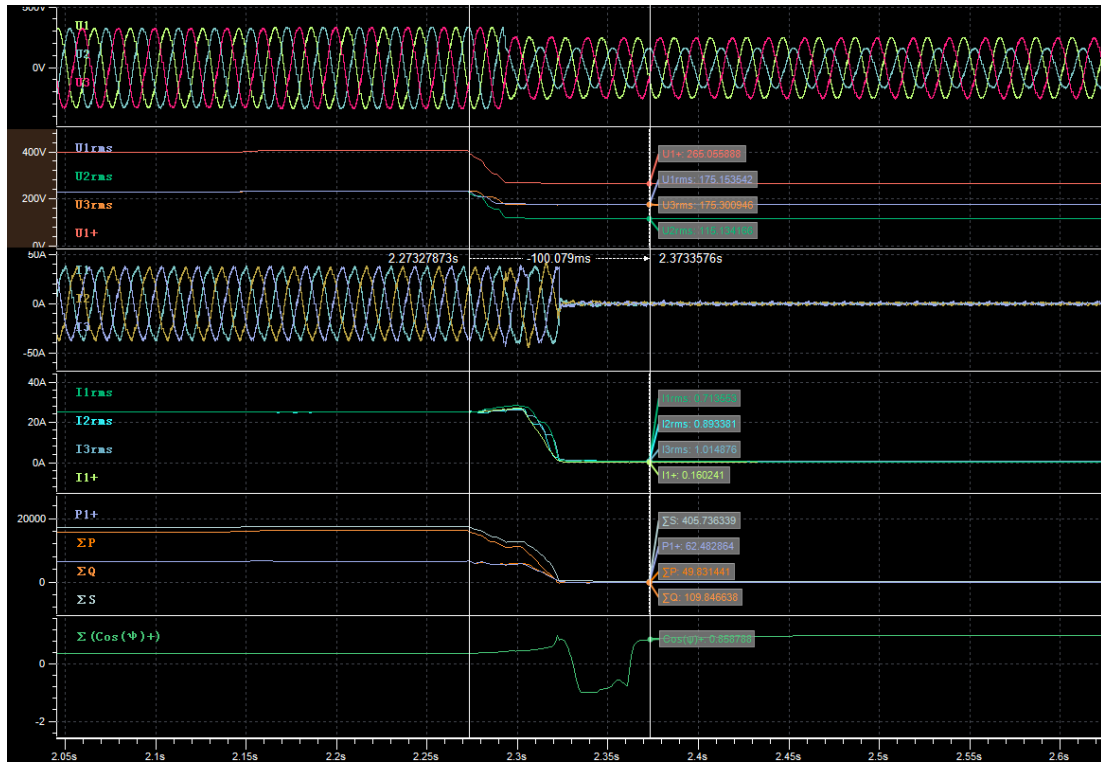

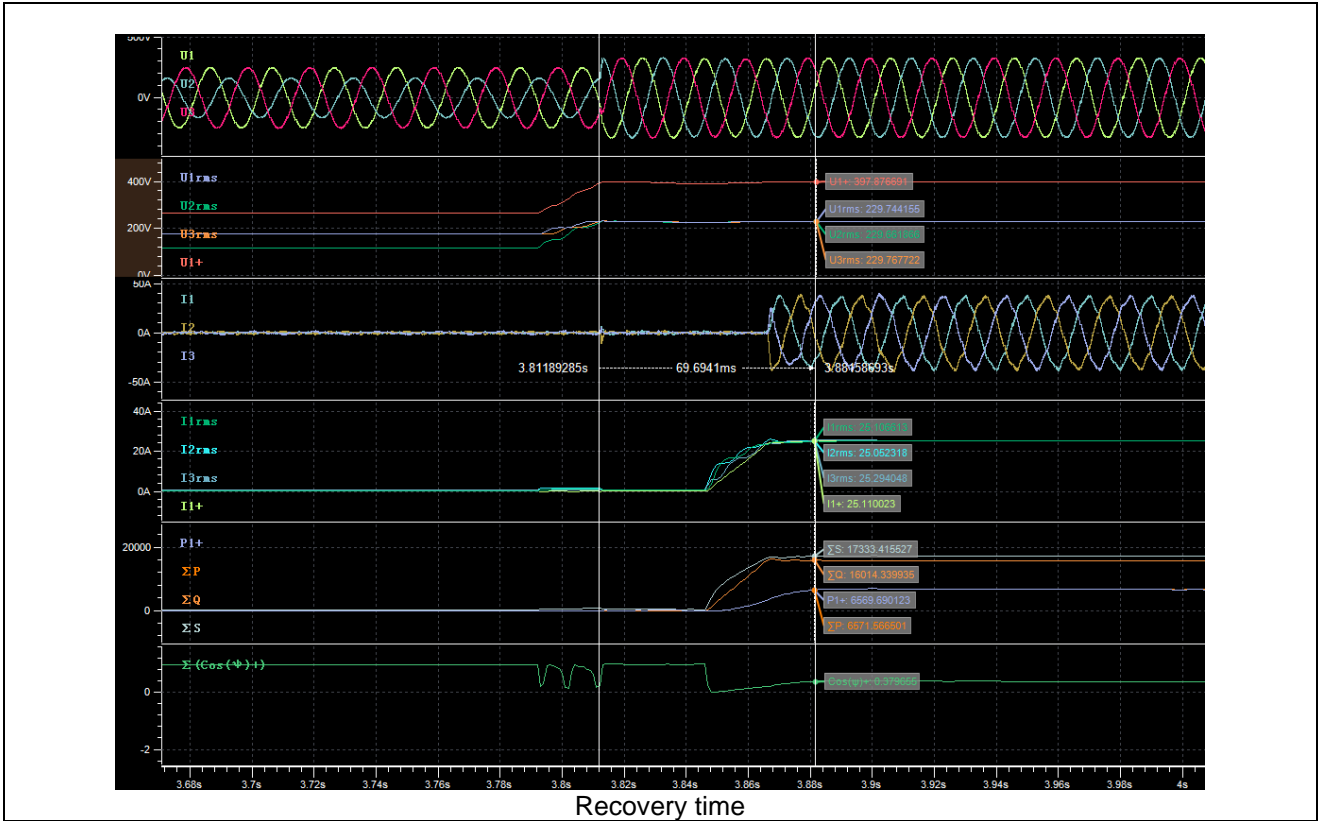



Graph of Test number 3.4

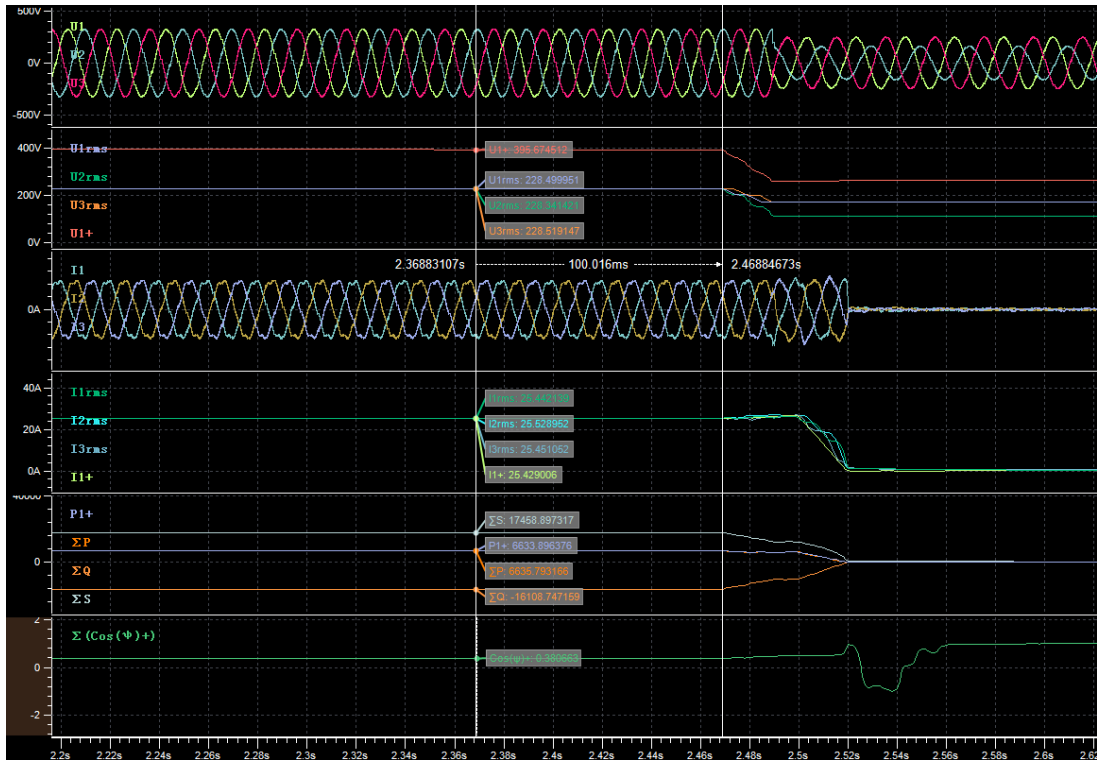

Before dip (t1-100ms)

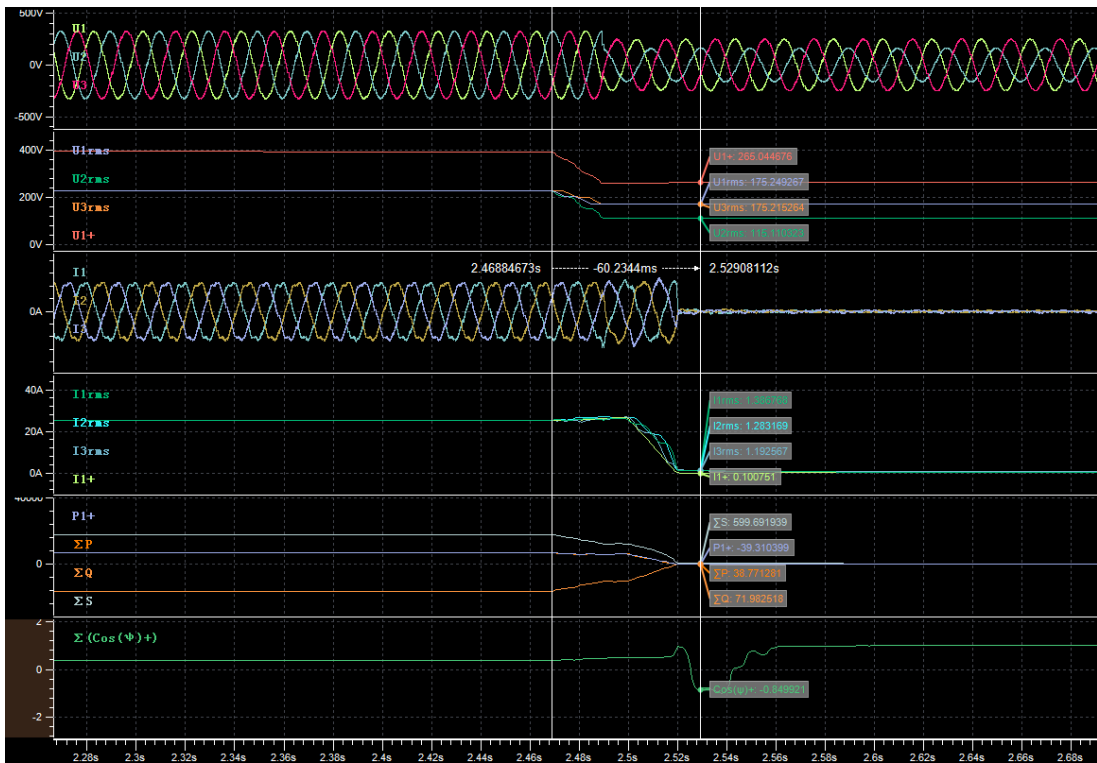

During dip (t1+60ms)

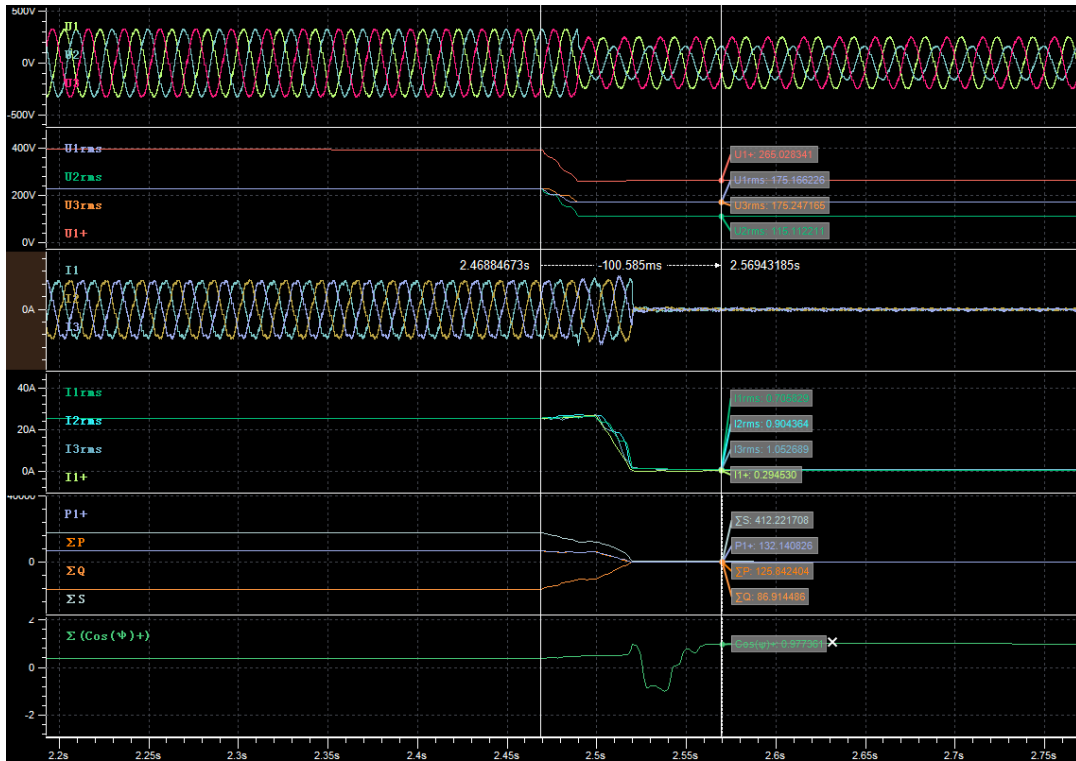

During dip (t1+100ms)

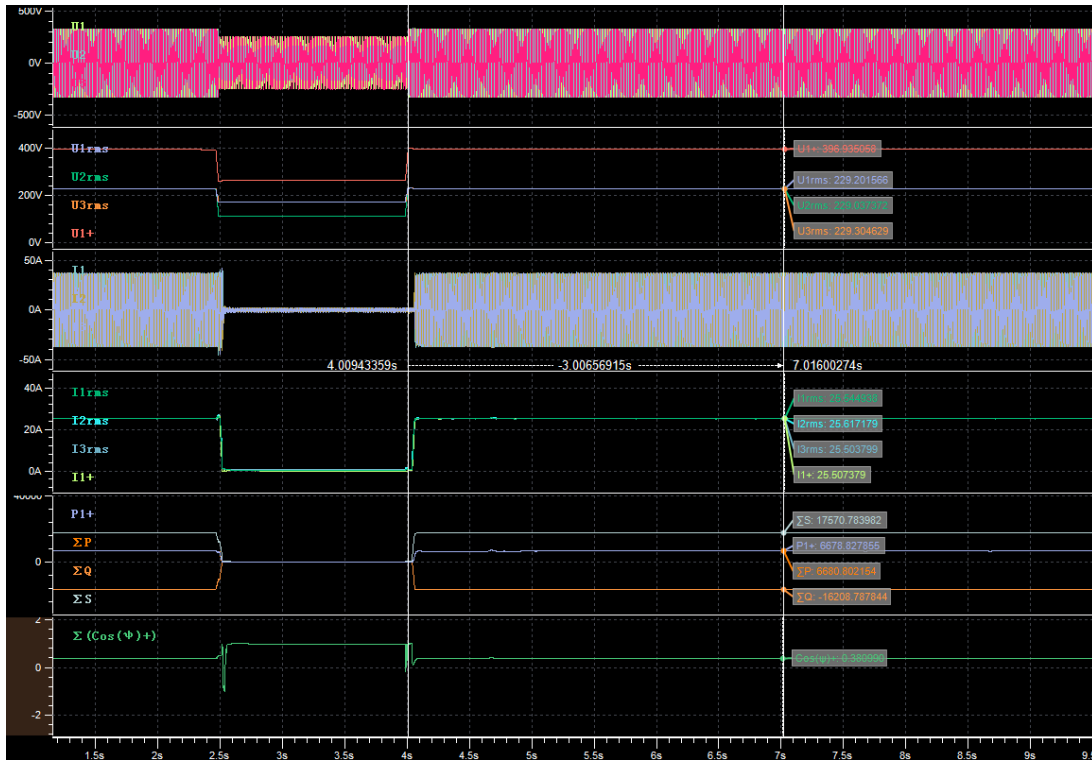

After dip (t2+3s)

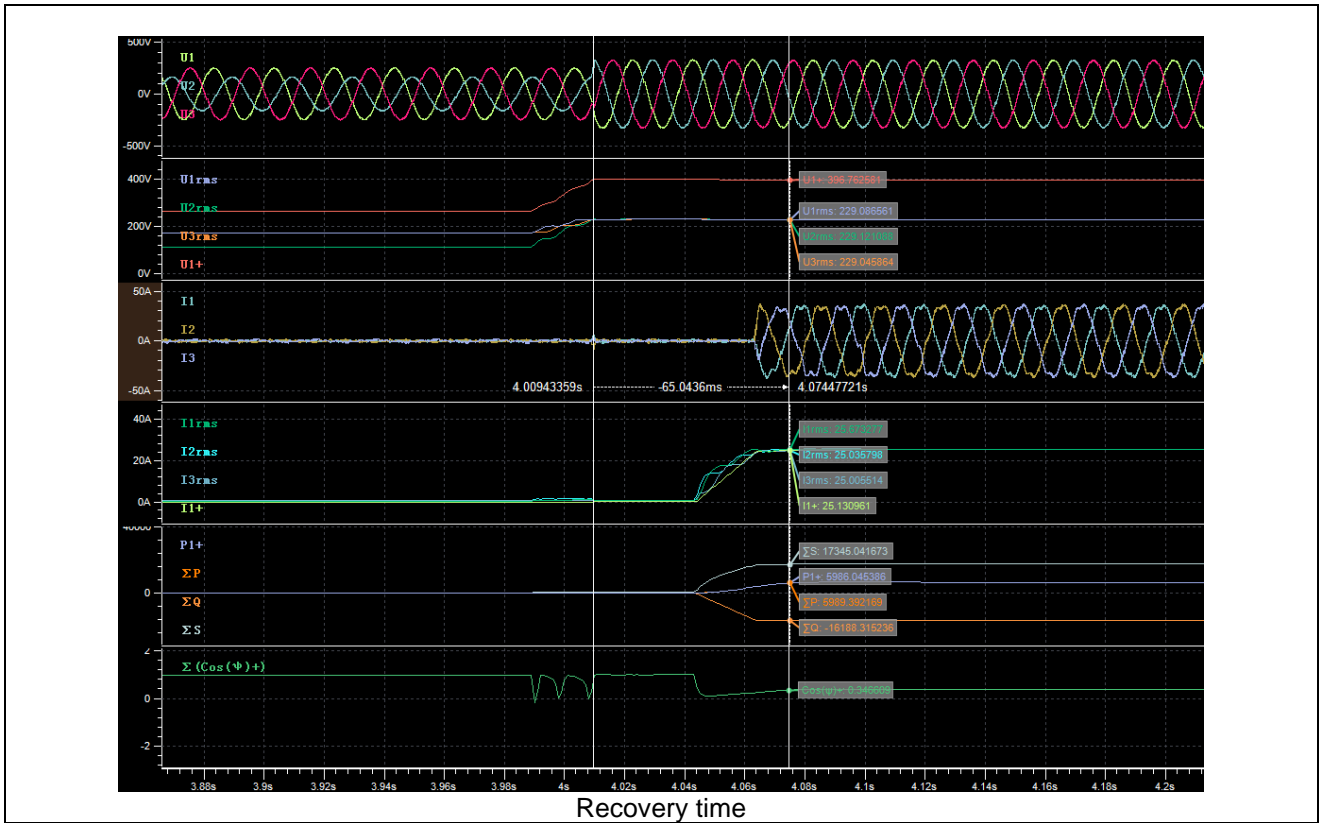

Graph of Test number 4.4

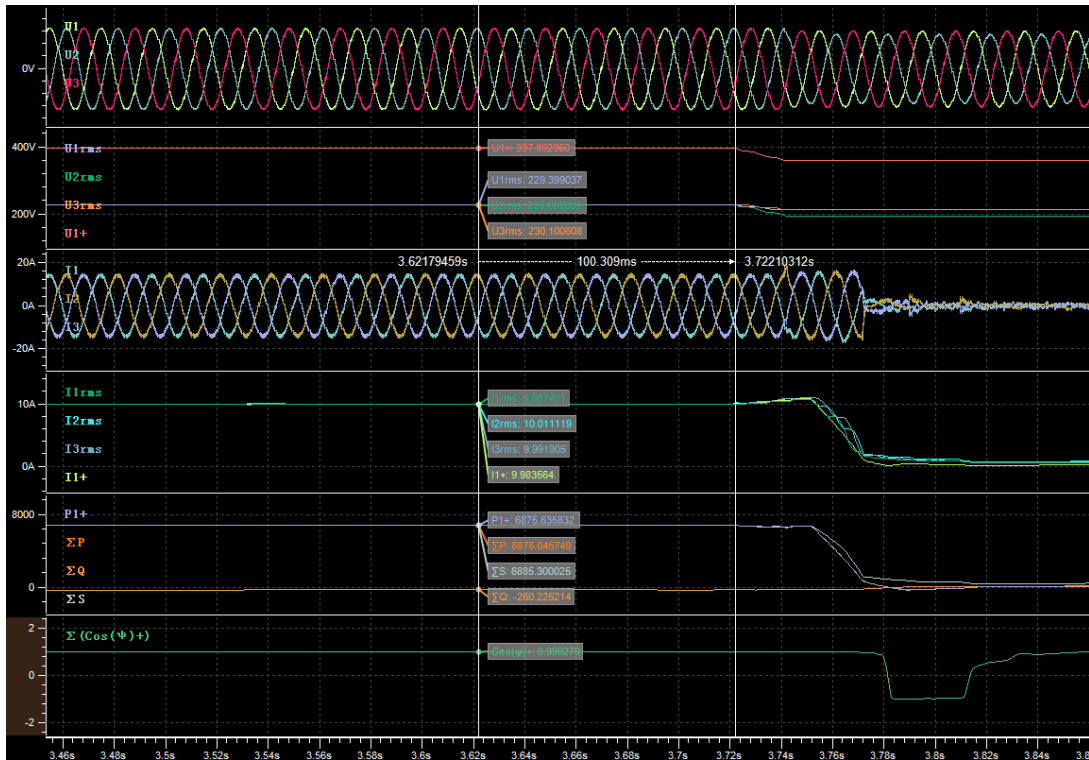

Before dip (t1-100ms)

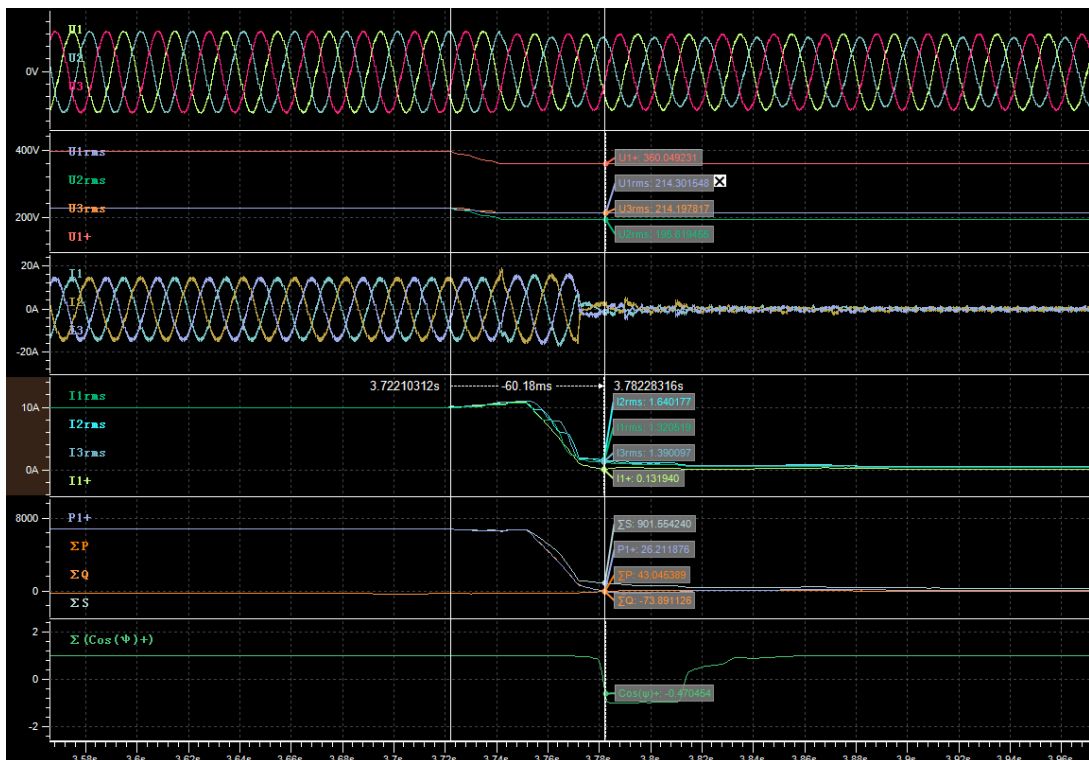

During dip (t1+60ms)

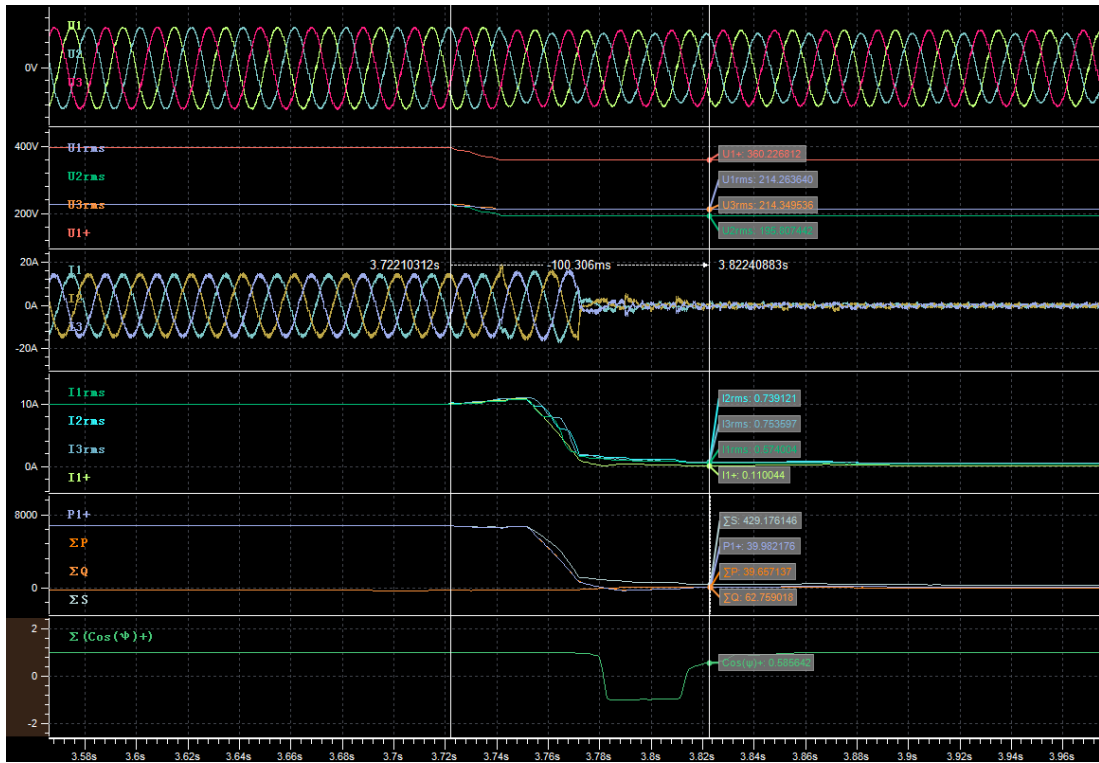

During dip (t1+100ms)

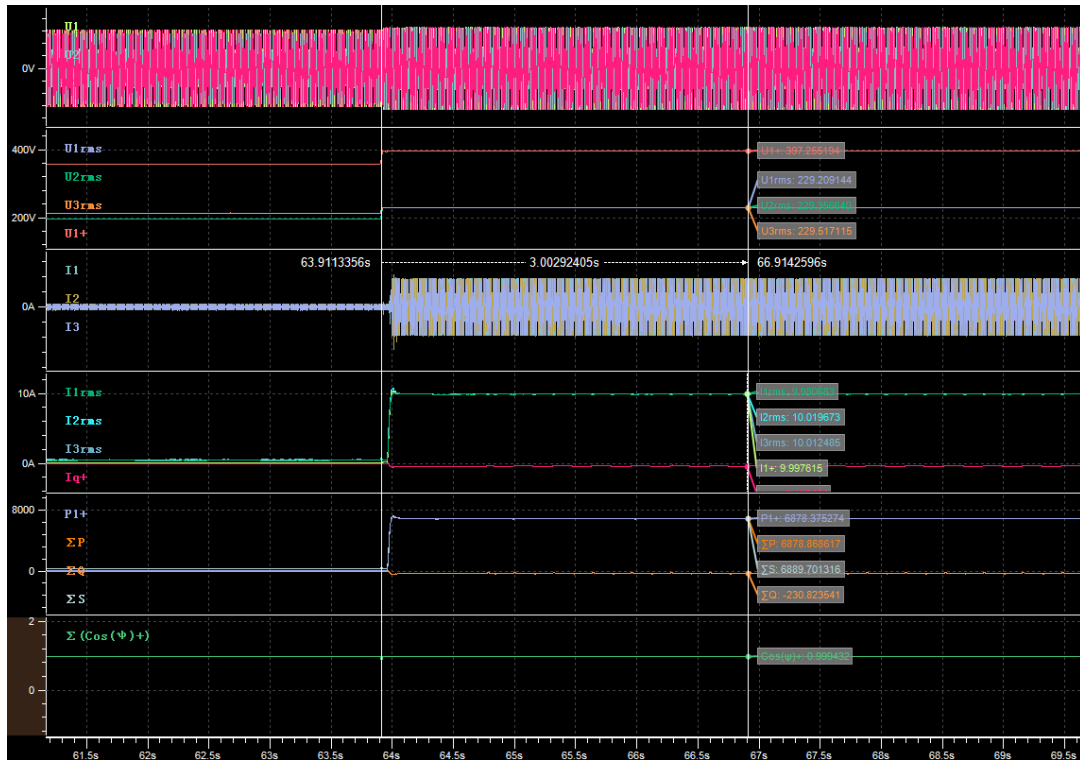

After dip (t2+3s)

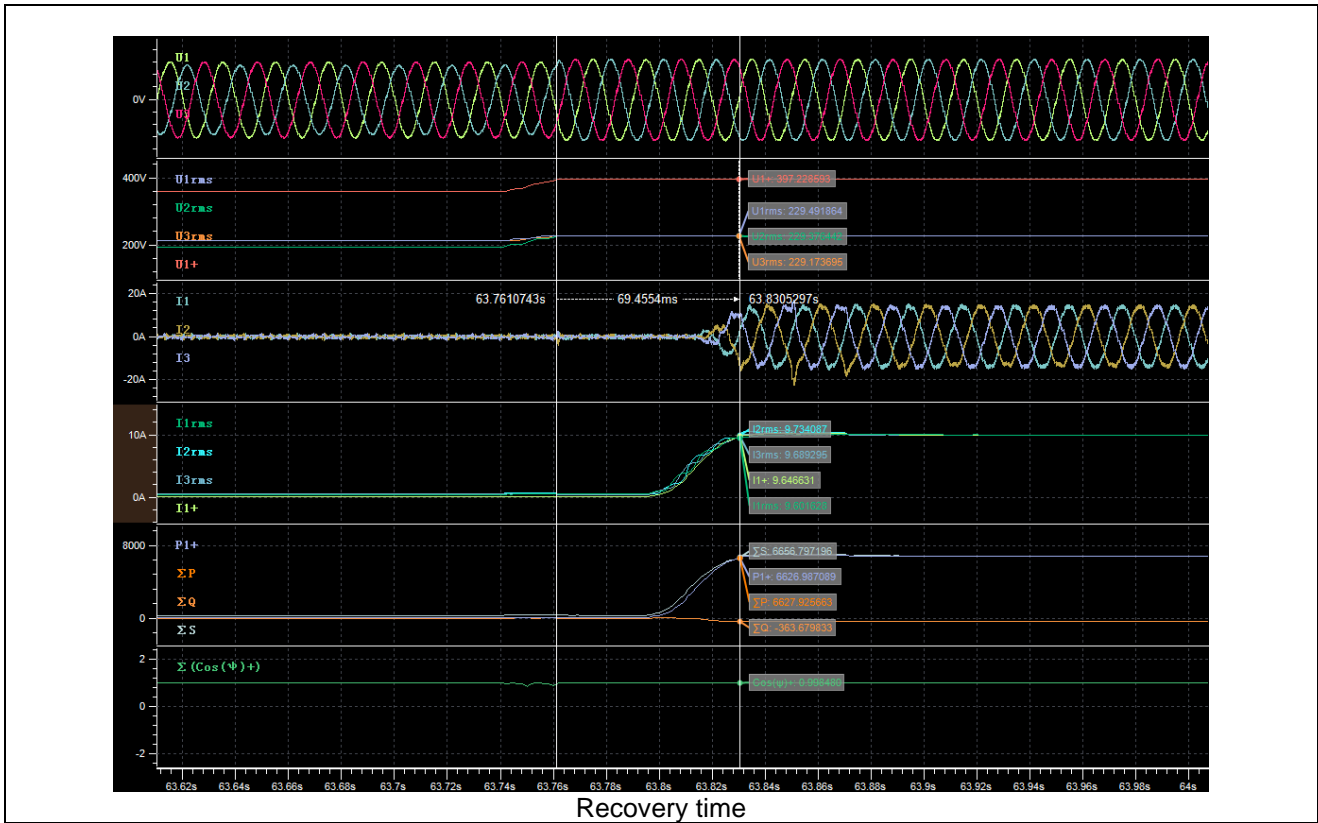

Graph of Test number 5.4

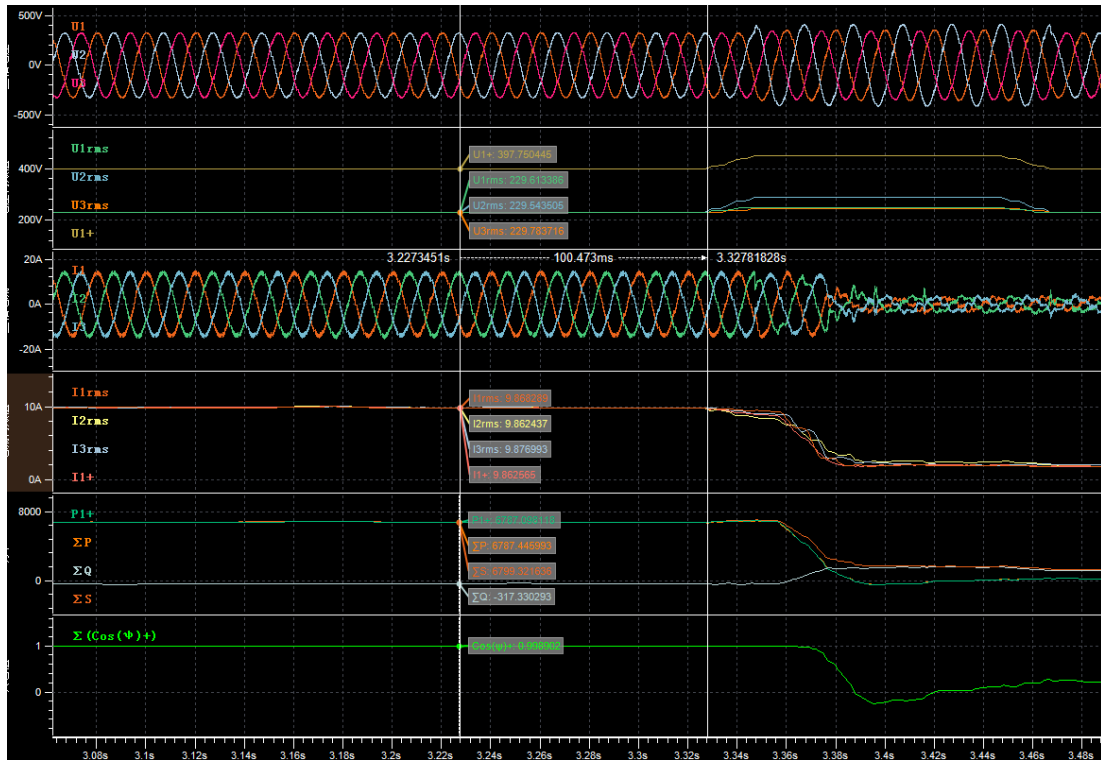

Before dip (t1-100ms)

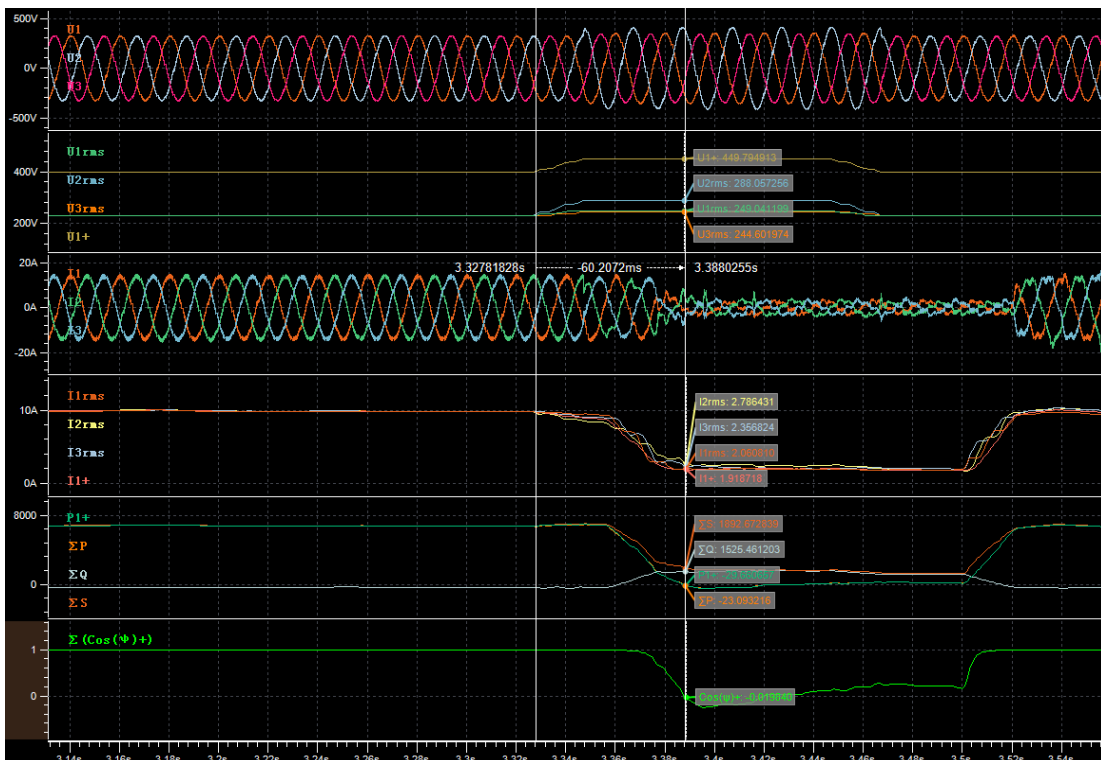

During dip (t1+60ms)

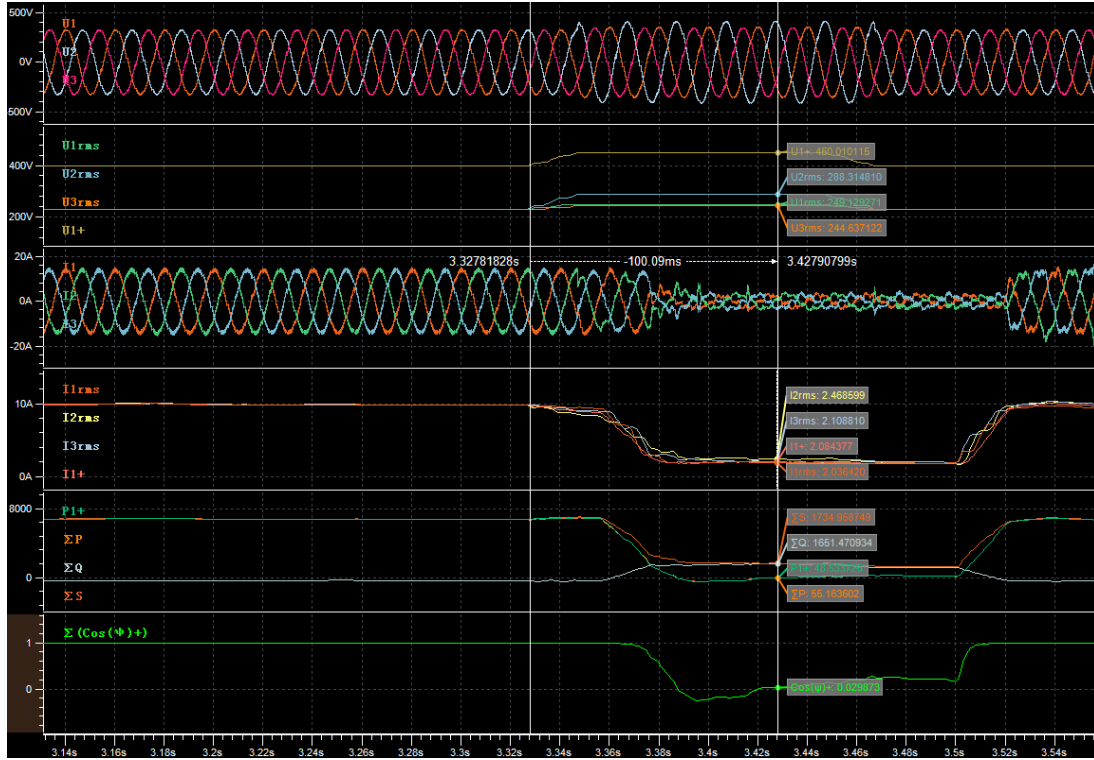

During dip (t1+100ms)

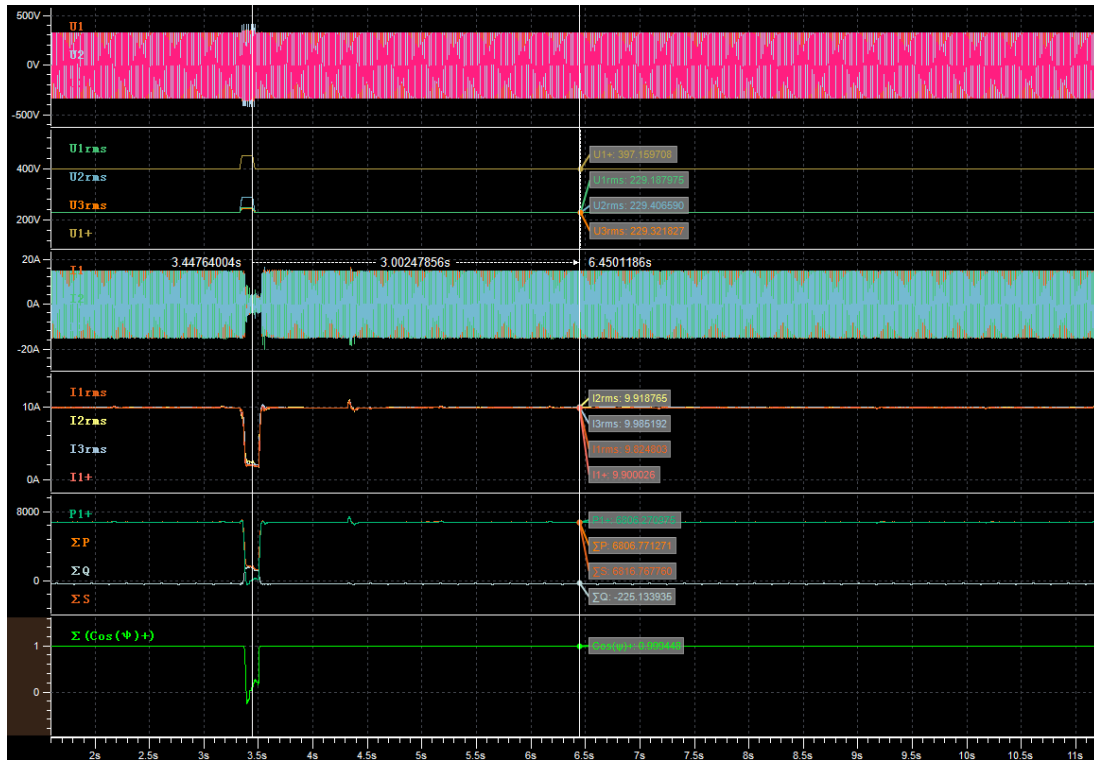

After dip (t2+3s)



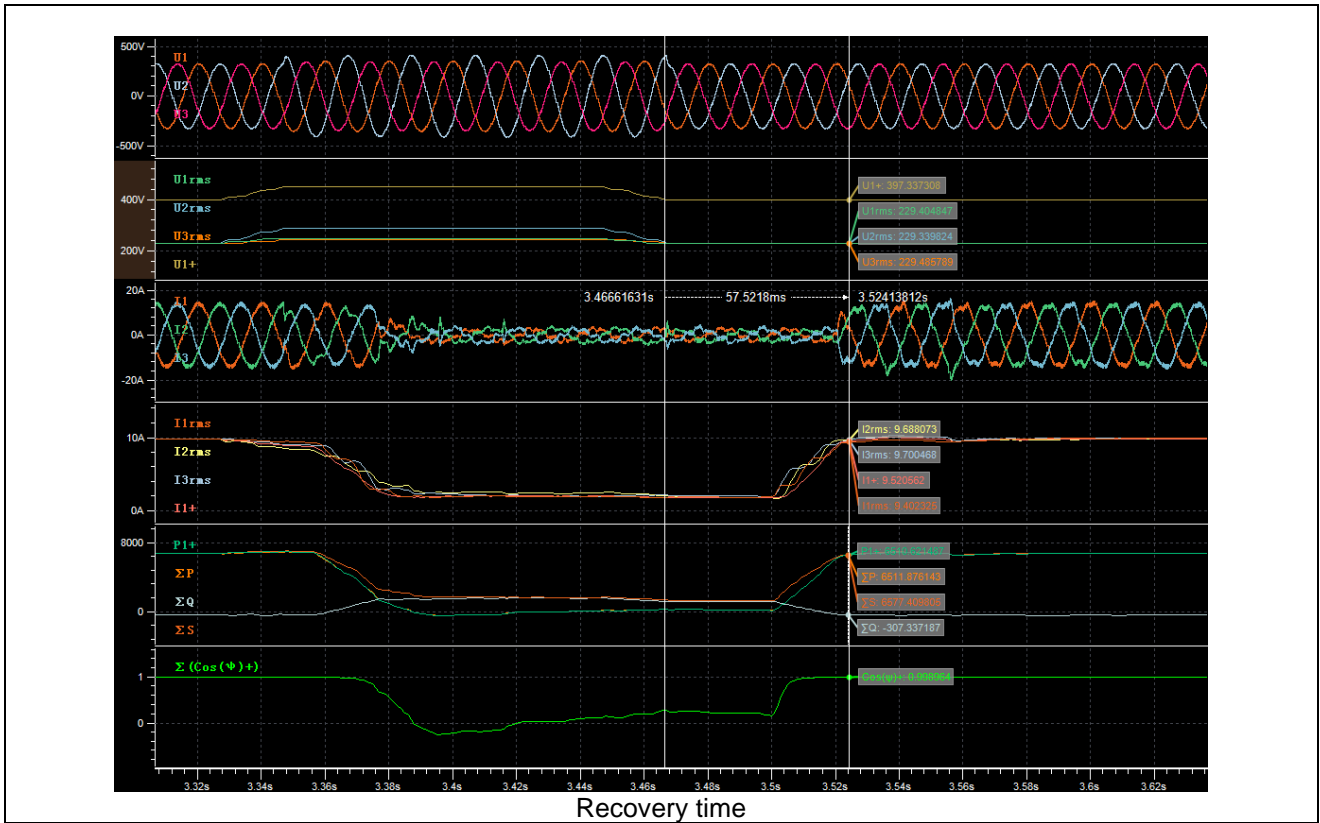

Verification of dynamic network support								P	
Short-circuited power at generator terminal [VA]			60K						
NS protection settings			See table 5.5 for detail.						
	No.	Parameter	Phase ref.	Time ref.	unit	Result			
General Info.	0	Test number	--	--	--	6.4	7.4	1.5	5.5
	1	Date	--	--	dd.mm.yyyy	20-April-2020 to 20-May-2020			
	2	Time (start of test)	--	--	hh:mm:ss.f	See graph			
	3	Fault type (phase)	--	--		D1	D1	D2	D2
	4	Setting voltage depth	Line to line	--	p.u.	1.20	1.15	0.15	1.25
	5	Setting dip duration		--	ms	5000	60000	150	100
	6	Point of fault entry	Total	--	ms	20ms			
	7	Point of fault clearance	Total	--	ms	20ms			
	8	Fault duration in empty load test	Total	--	ms	5015.5	60021	160.55	100.92
	9	Voltage depth/height in empty load test	Total	t1+100ms to t2 and t1-10s to t1	p.u.	1.062	1.042	0.150	1.253
10	Positive sequence					1.203	1.152	0.622	1.062
					1.052	1.042	0.622	1.082	
Before dip <t1	11	Voltage	Line to neutral	t1-10s to t1	p.u.	1.00	1.00	1.00	1.00
	12	Current	Positive sequence	t1-500ms to t1-100ms	p.u.	0.21	0.21	1.00	1.00
	13	Active power	Total	t1-10s to t1	p.u.	0.206	0.206	1.01	1.01
	14		Positive sequence			0.206	0.206	1.01	1.01
	15	Reactive power	Total	t1-10s to t1	p.u.	-0.008	-0.009	-0.009	-0.009
	16		Positive sequence			-0.008	-0.009	-0.009	-0.009
	17	Cosφ	--	t1-10s to t1	--	0.9991	0.9989	0.9999	0.9999
During dip t1 to t2	18	Voltage	Phase 1	t1+100ms to t2-20ms	p.u.	1.063	1.043	0.150	1.253
			Phase 2			1.203	1.152	0.622	1.062
			Phase 3			1.053	1.043	0.622	1.082

	19	Line current	Phase 1	t1+60ms	p.u.	0.048	0.046	0.026	0.025
	20		Phase 2			0.062	0.057	0.022	0.058
	21		Phase 3			0.050	0.047	0.026	0.056
	22	Line current	Phase 1	t1+100ms	p.u.	0.043	0.041	0.024	0.013
	23		Phase 2			0.048	0.047	0.016	0.026
	24		Phase 3			0.045	0.045	0.021	0.020
	25	Active power	Total	t1+100ms to t2-20ms	p.u.	0.007	0.007	0.003	0.011
26	Positive sequence		0.007			0.007	0.002	0.011	
After dip > t2	27	Voltage	Line to neutral	t2+3s to t2+10s	p.u.	1.00	1.00	1.00	1.00
	28	Active power	Positive sequence.	t2+3s to t2+10s	p.u.	0.206	0.206	1.01	1.01
	29		Total			0.206	0.206	1.01	1.01
	39	Active power rising time	Positive sequence	--	s	0.057	0.056	0.236	0.073
	31	Reactive power	Positive sequence	t2+3s to t2+10s	p.u.	-0.009	-0.008	-0.007	-0.007
	32		Total			-0.009	-0.008	-0.007	-0.007
	33	Reactive power rising time	Positive sequence	--	s	0.057	0.056	0.236	0.073
	34	PGU does not disconnect from grid till 60s after fault	--	t2 to t2+60s	Yes / No	Yes			

Graph of Test number 6.4



Before dip (t1-100ms)

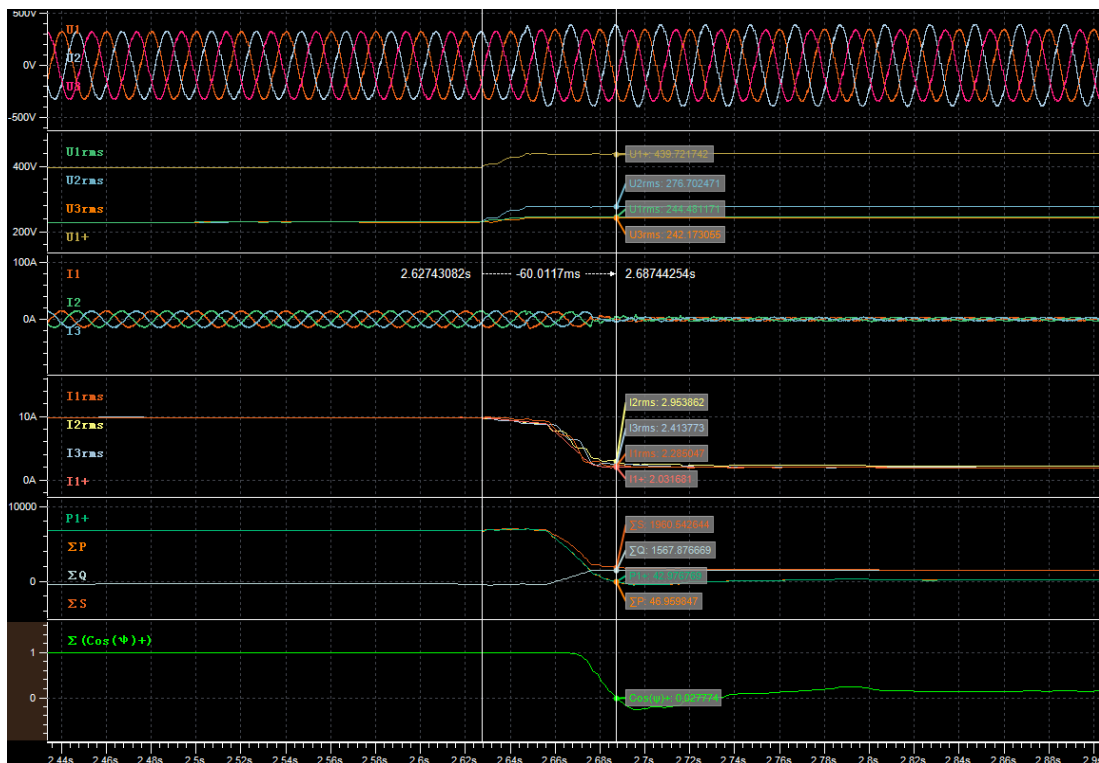

During dip (t1+60ms)

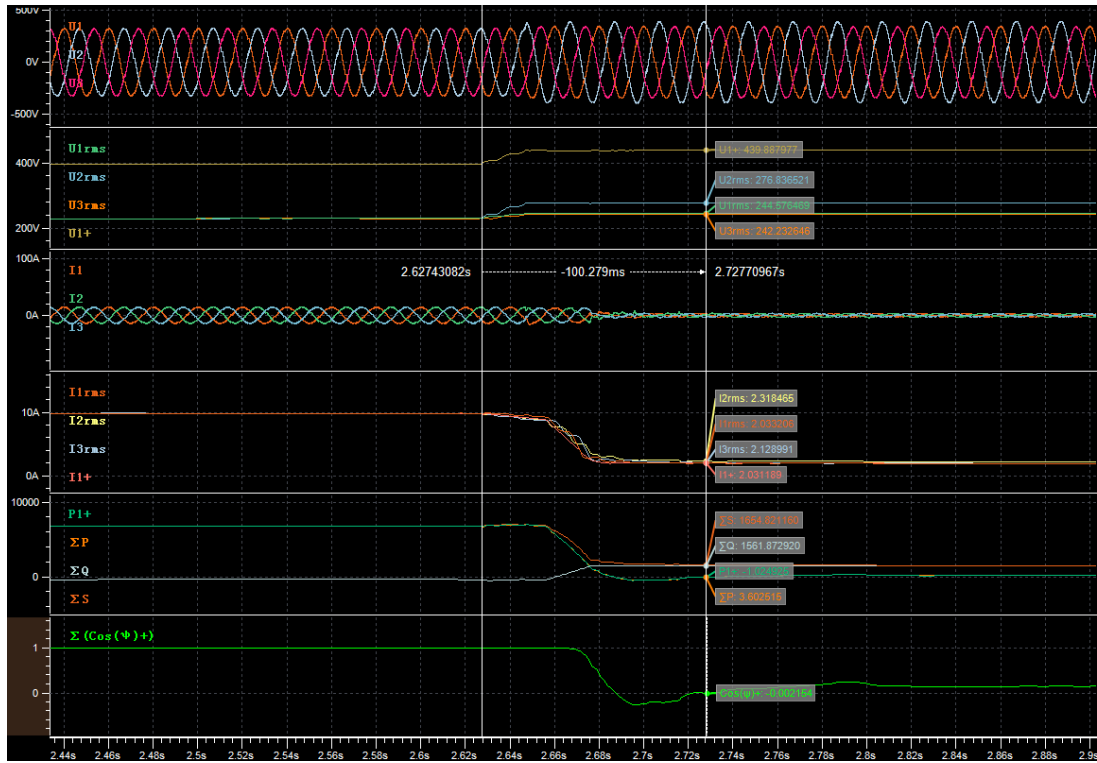

During dip (t1+100ms)

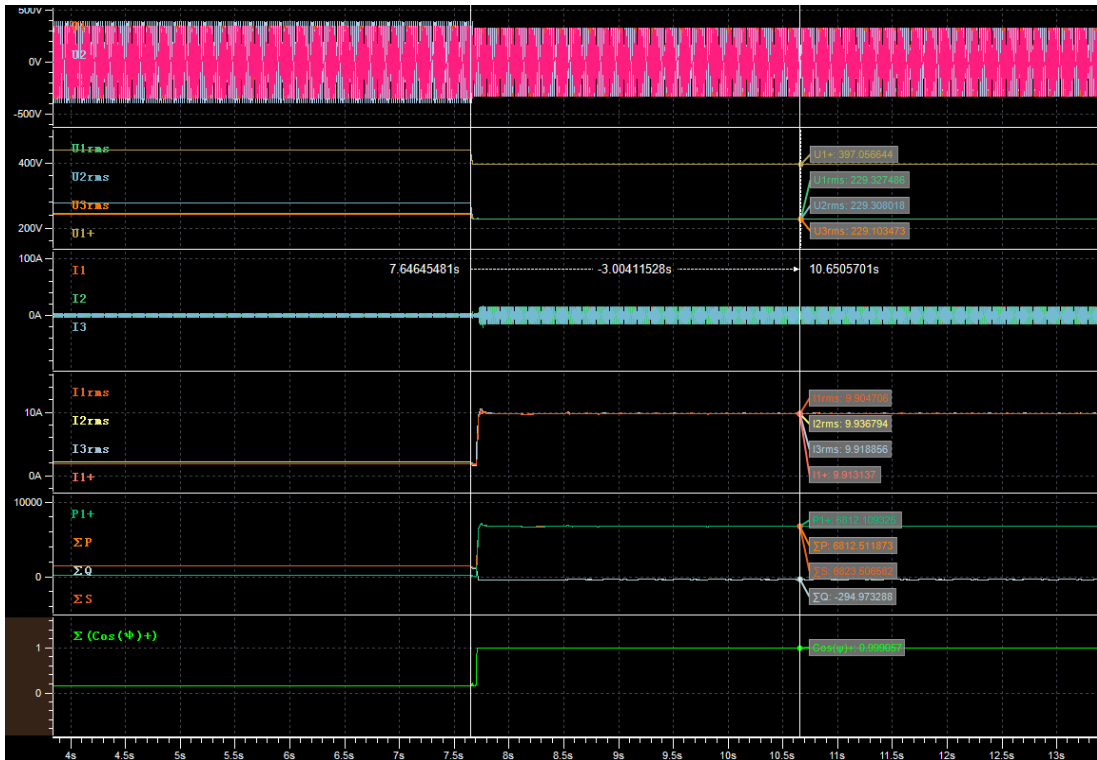

After dip (t2+3s)

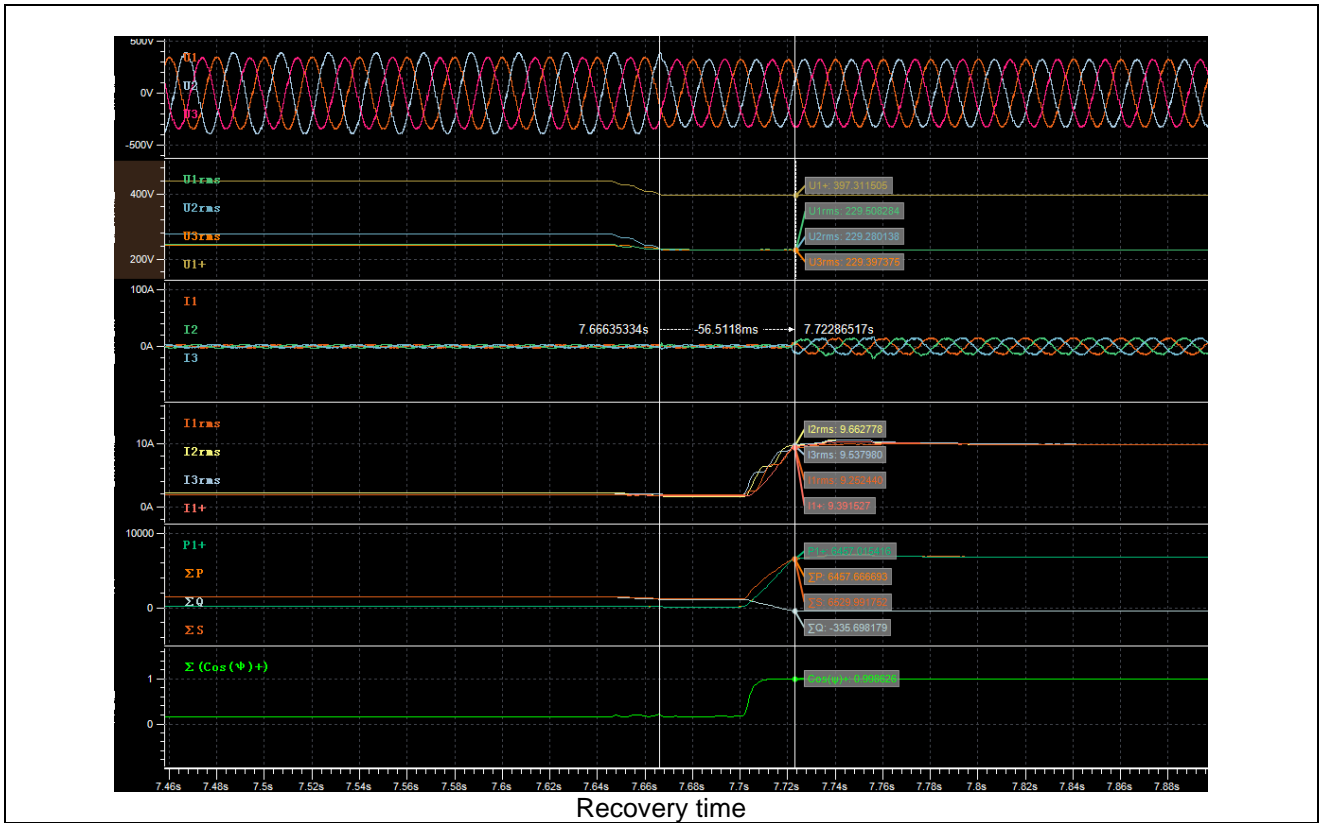

Graph of Test number 7.4

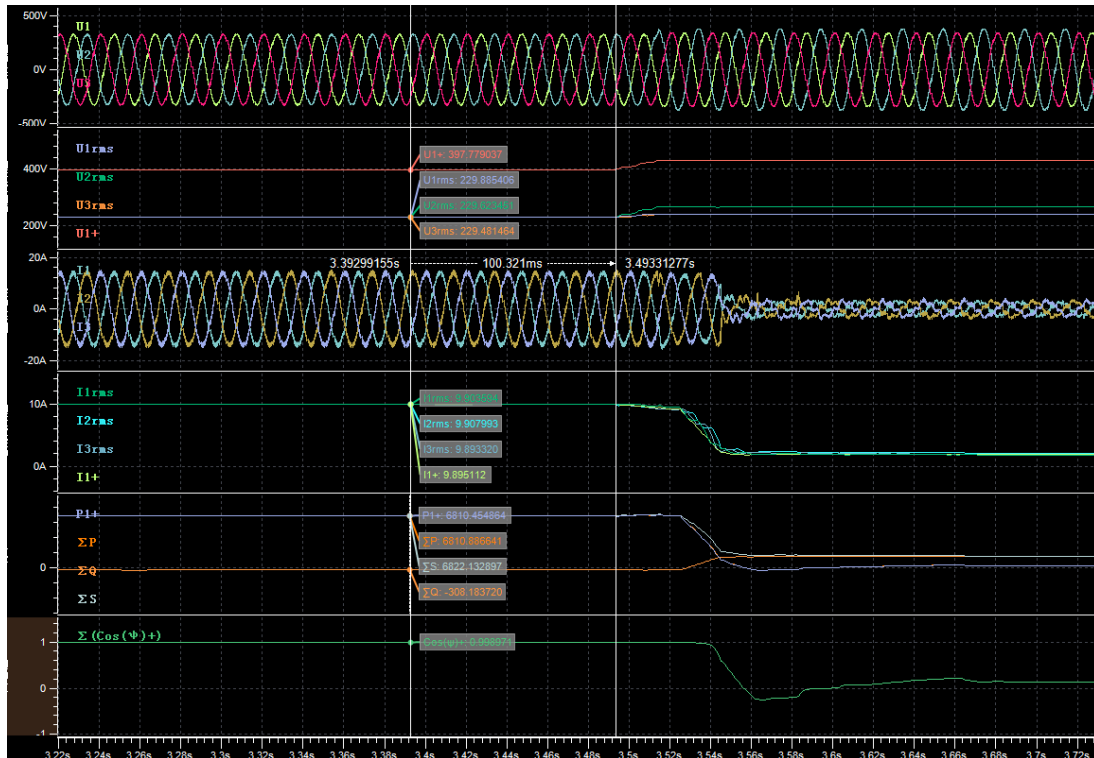

Before dip (t1-100ms)

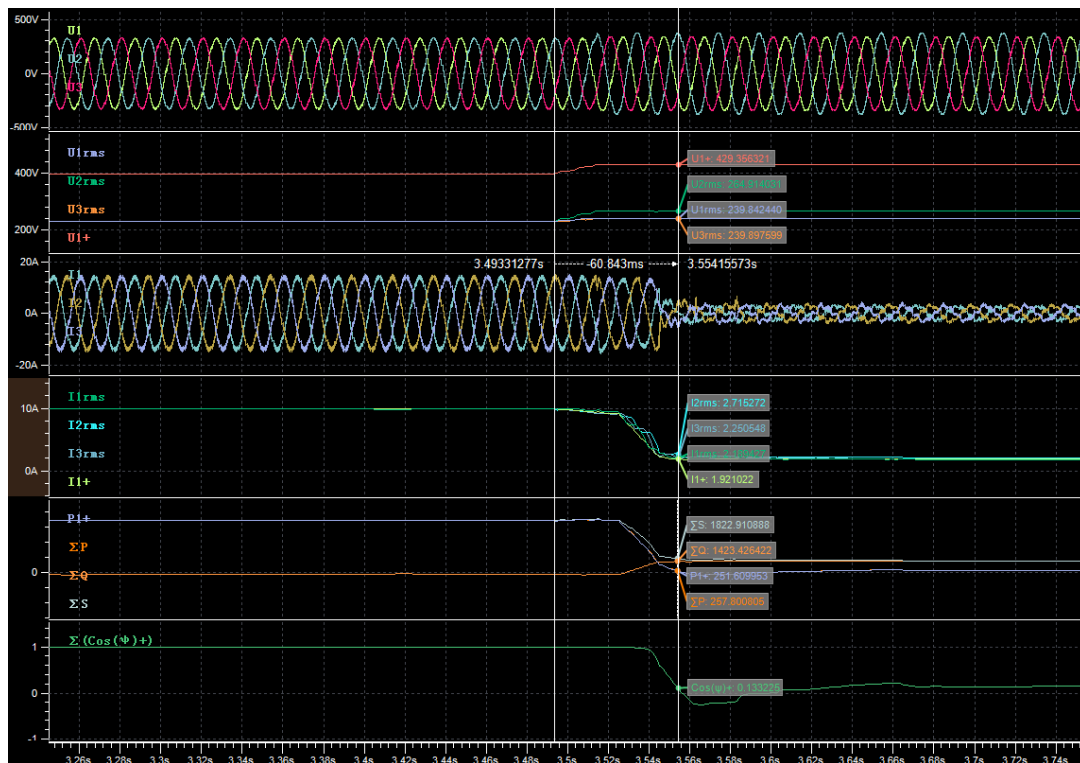

During dip (t1+60ms)

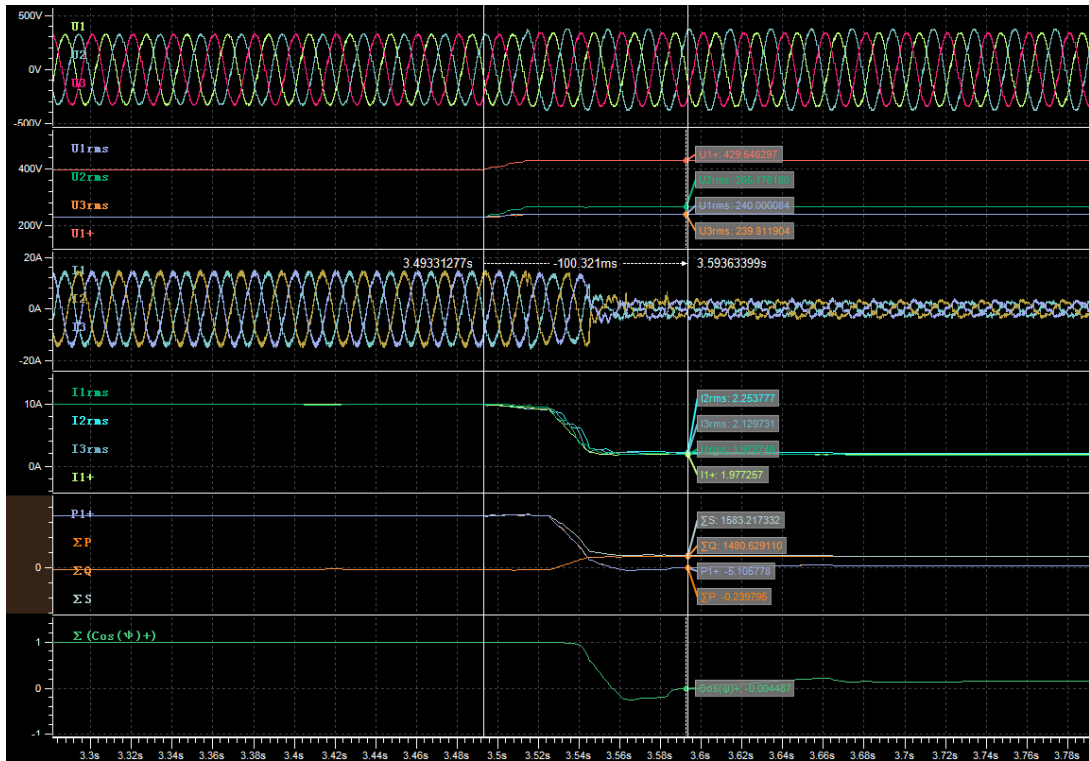

During dip (t1+100ms)

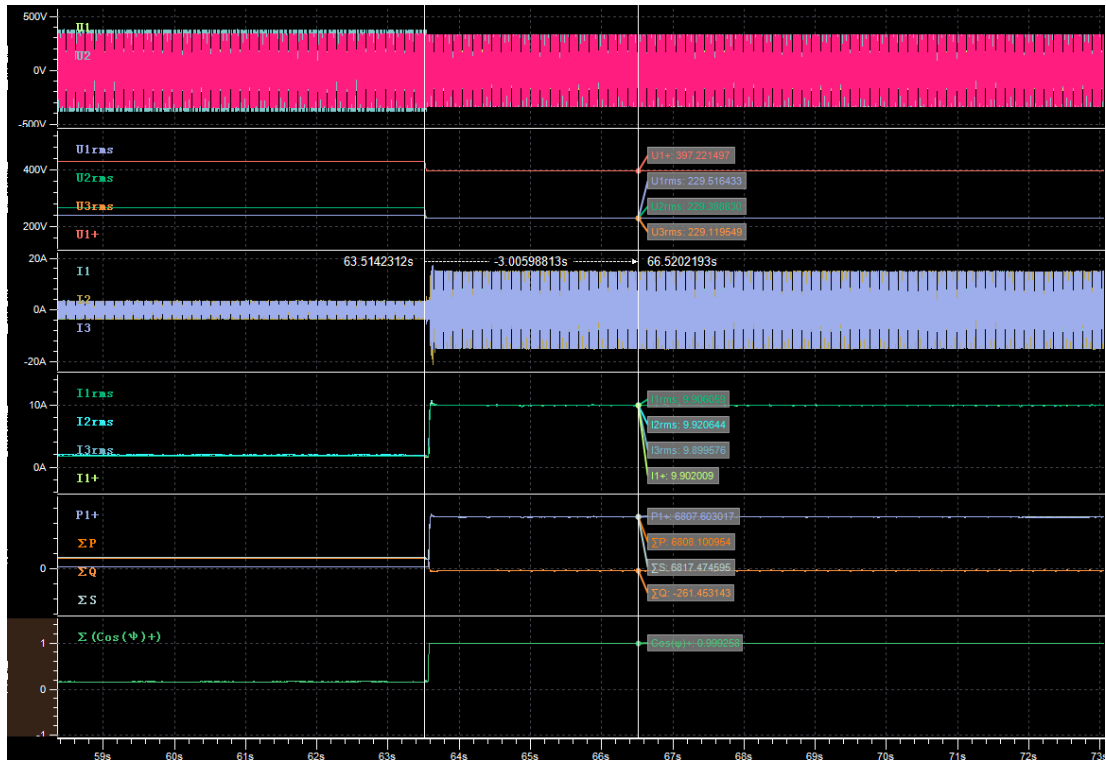

After dip (t2+3s)



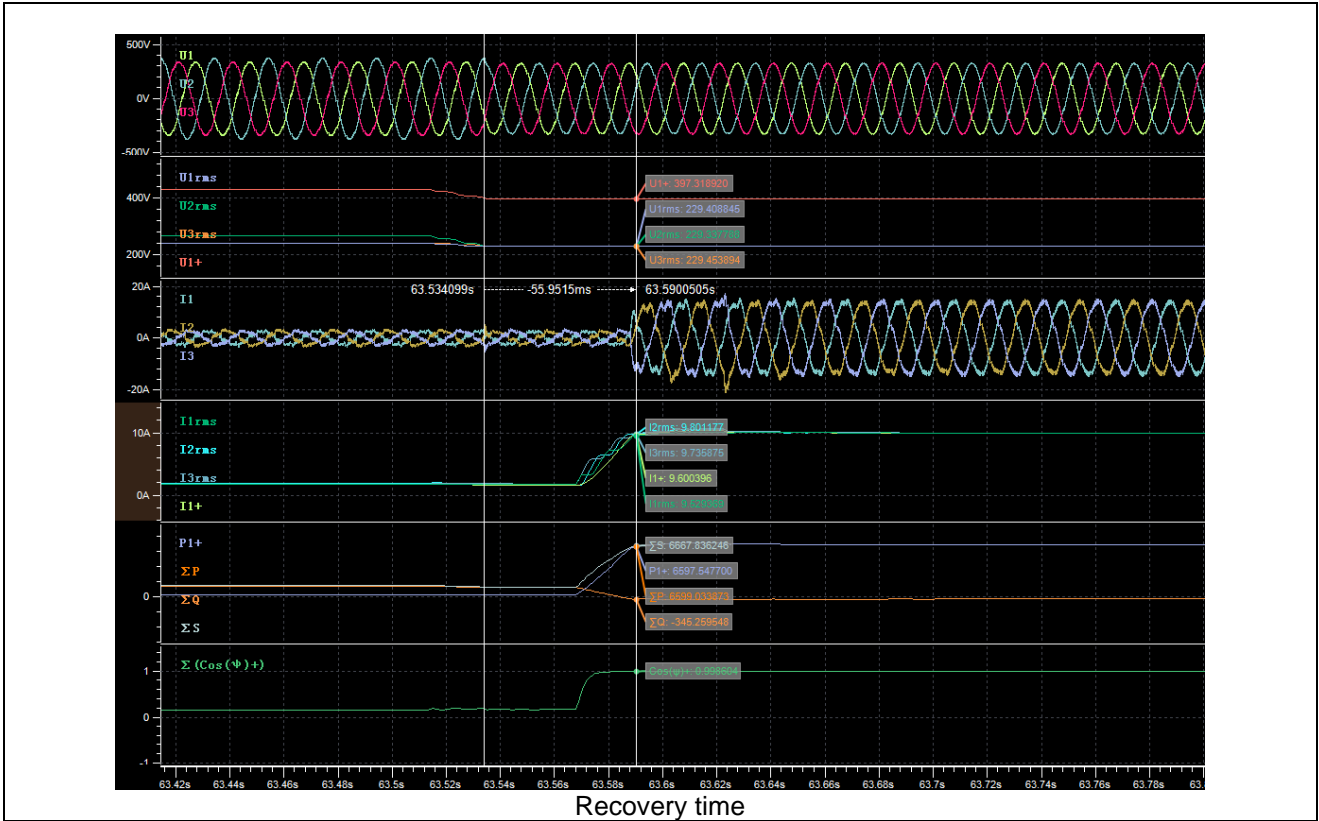

Graph of Test number 1.5

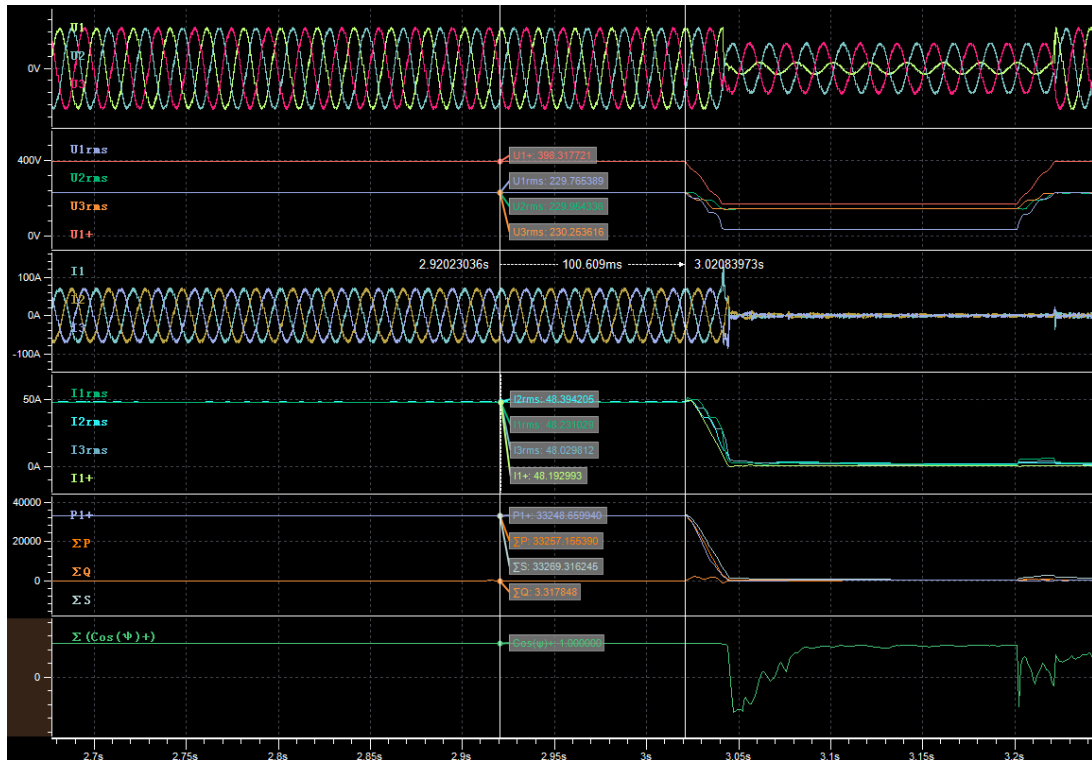

Before dip (t1-100ms)

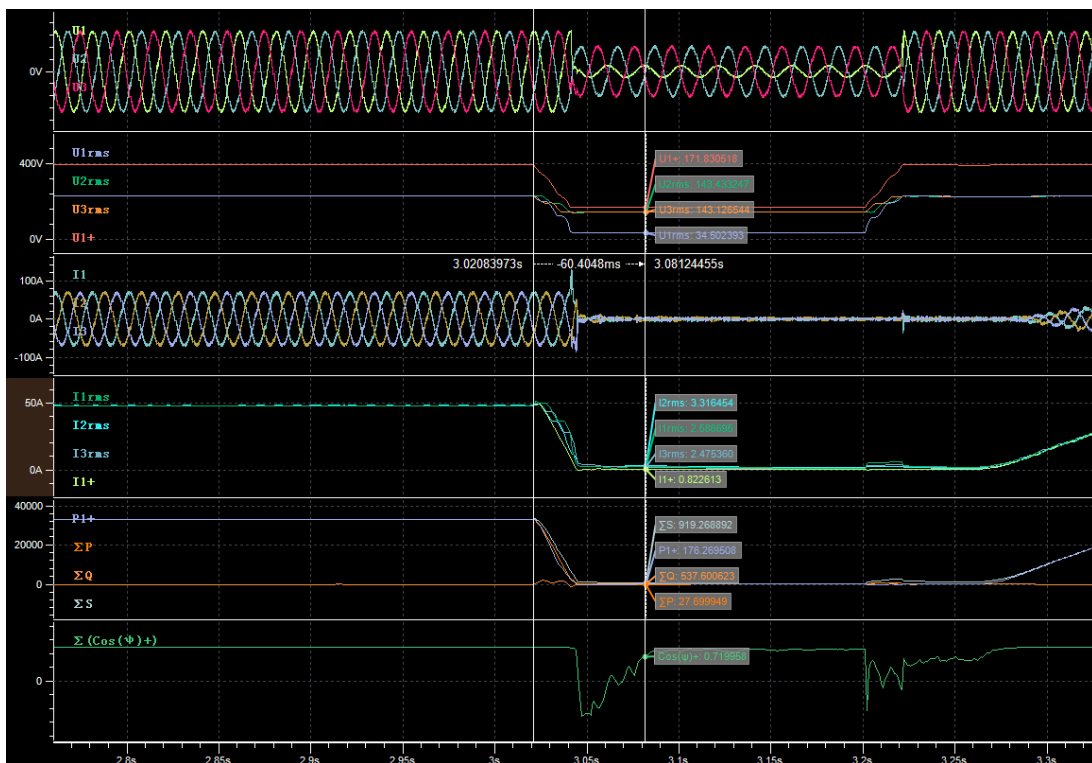

During dip (t1+60ms)

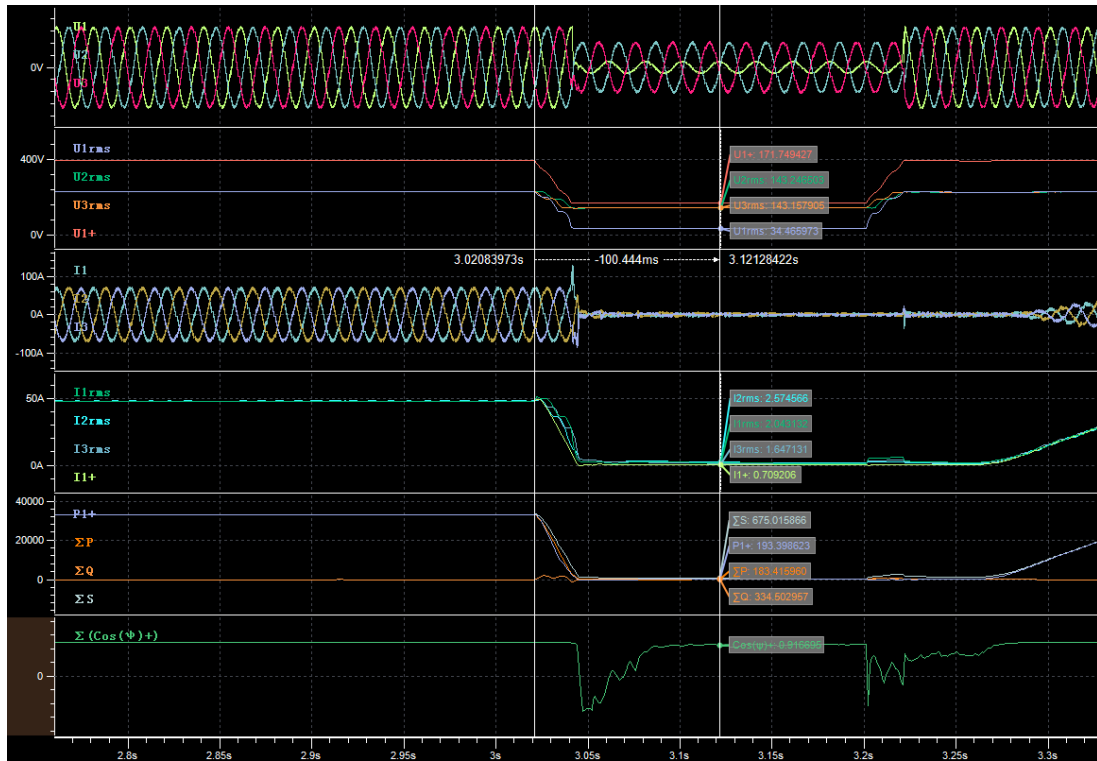

During dip (t1+100ms)

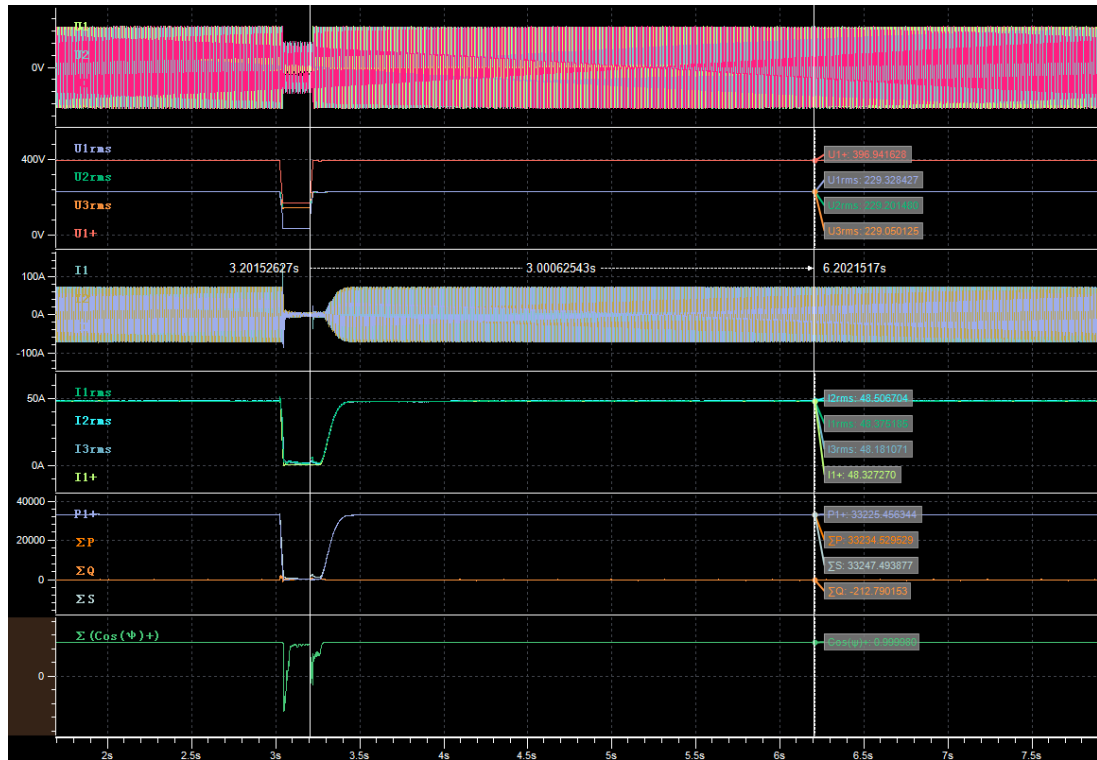

After dip (t2+3s)

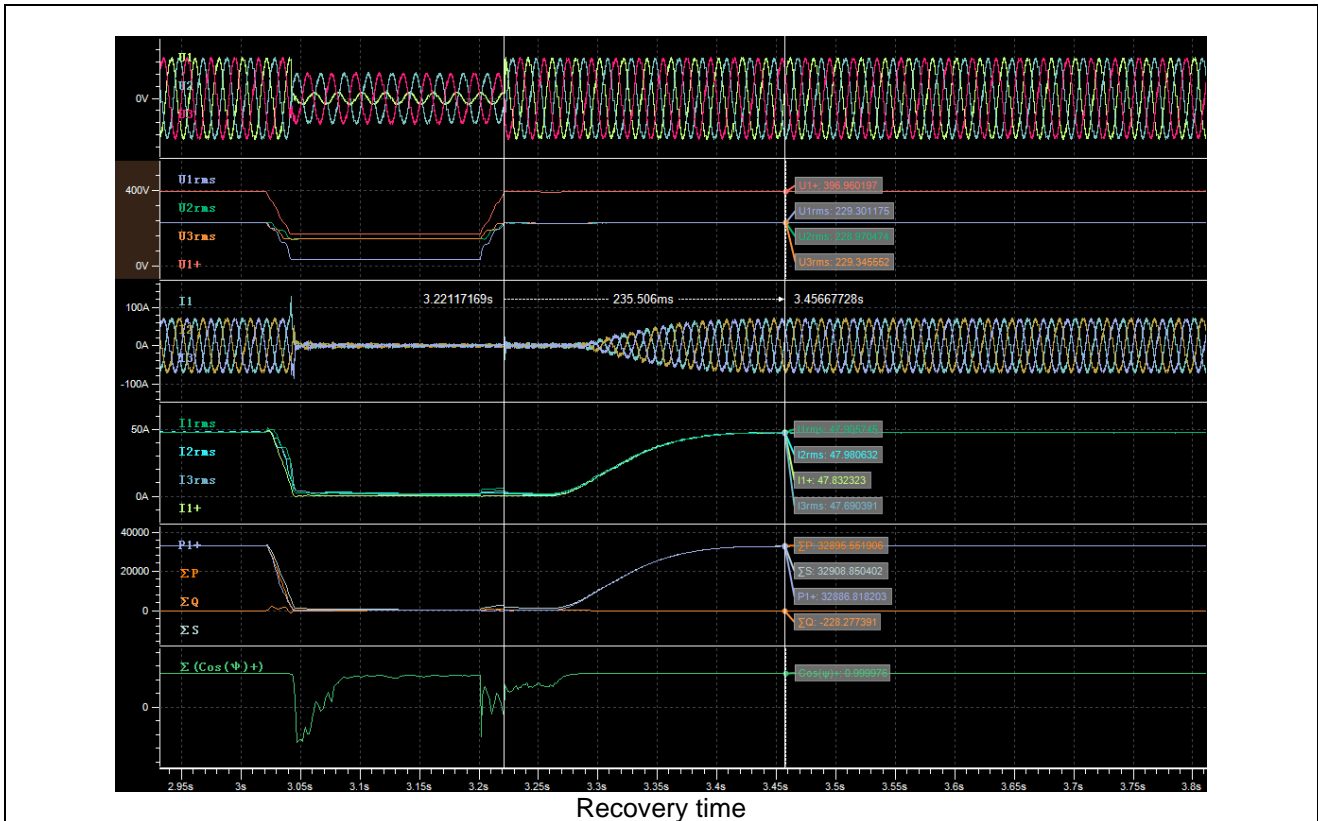

Graph of Test number 5.5

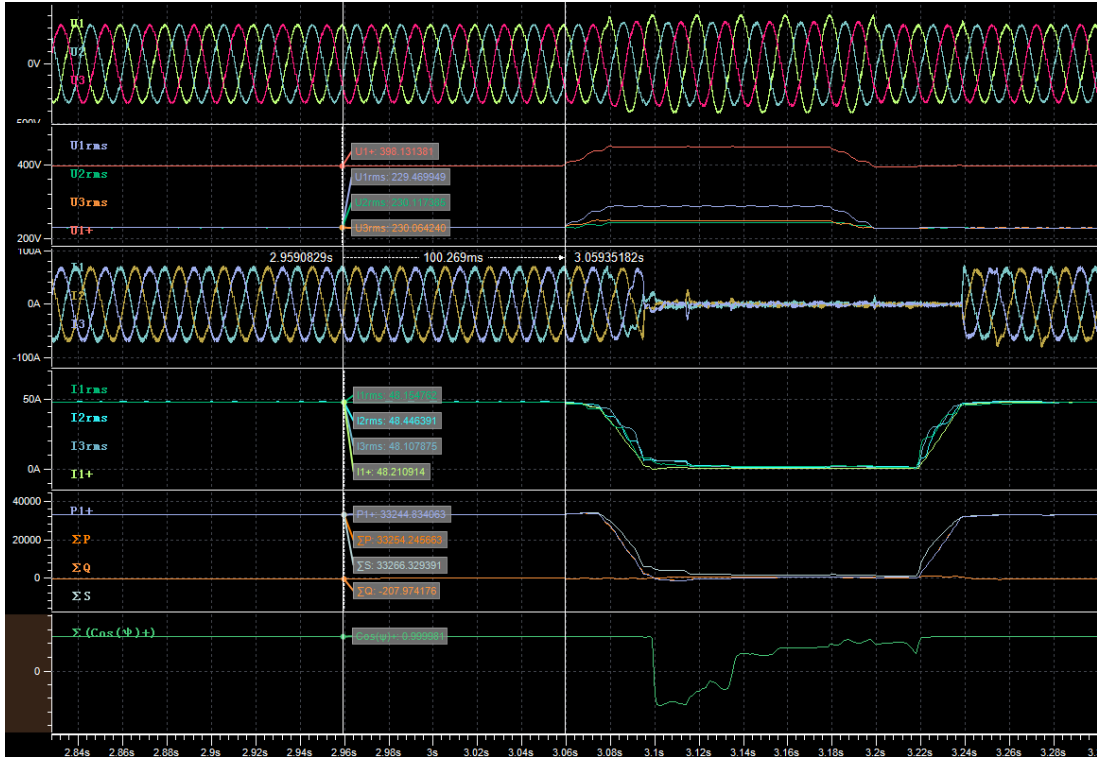

Before dip (t1-100ms)

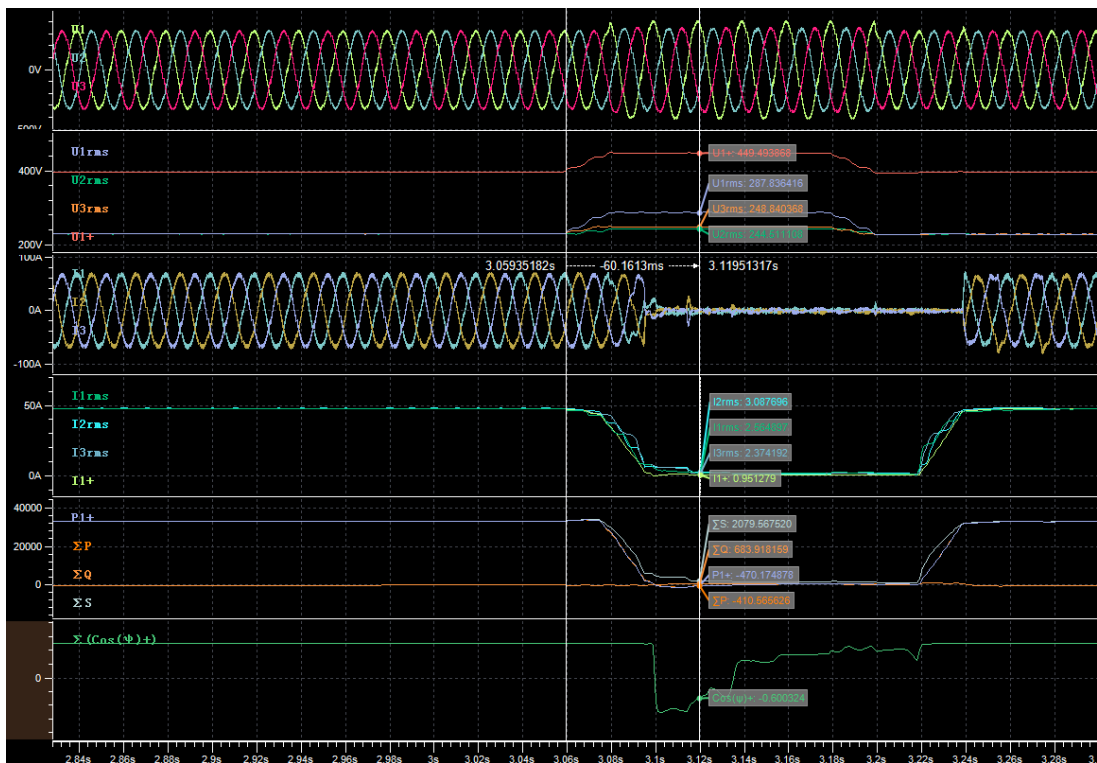

During dip (t1+60ms)

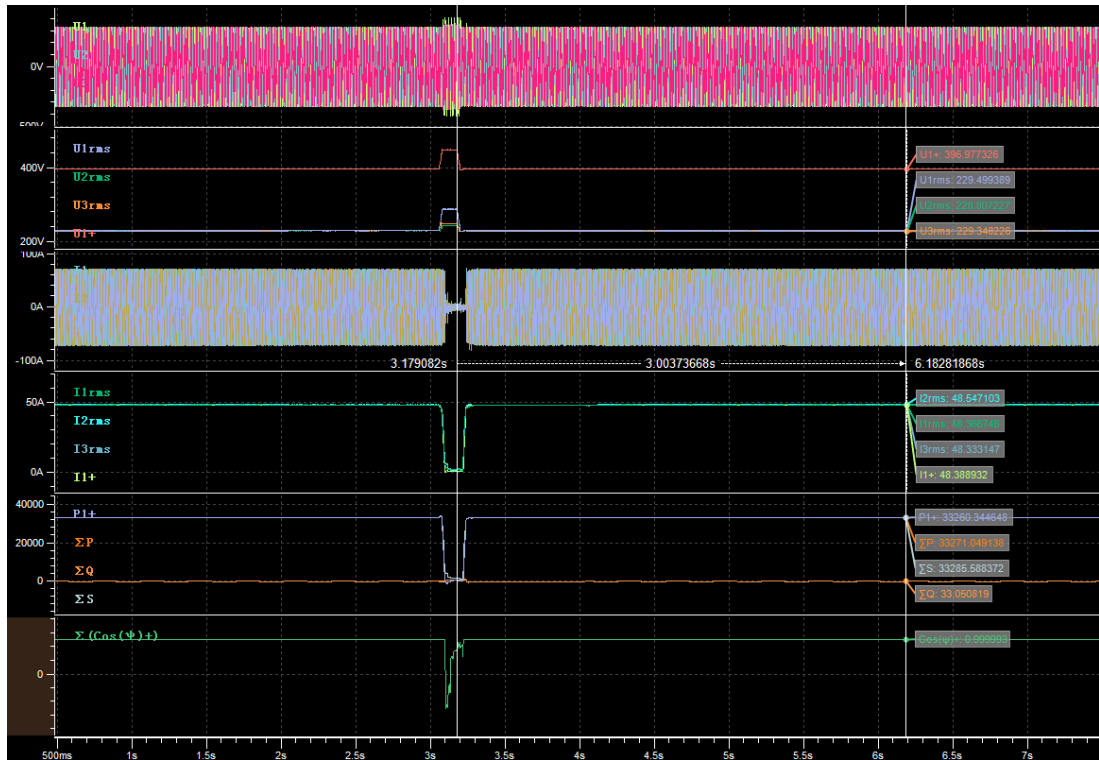
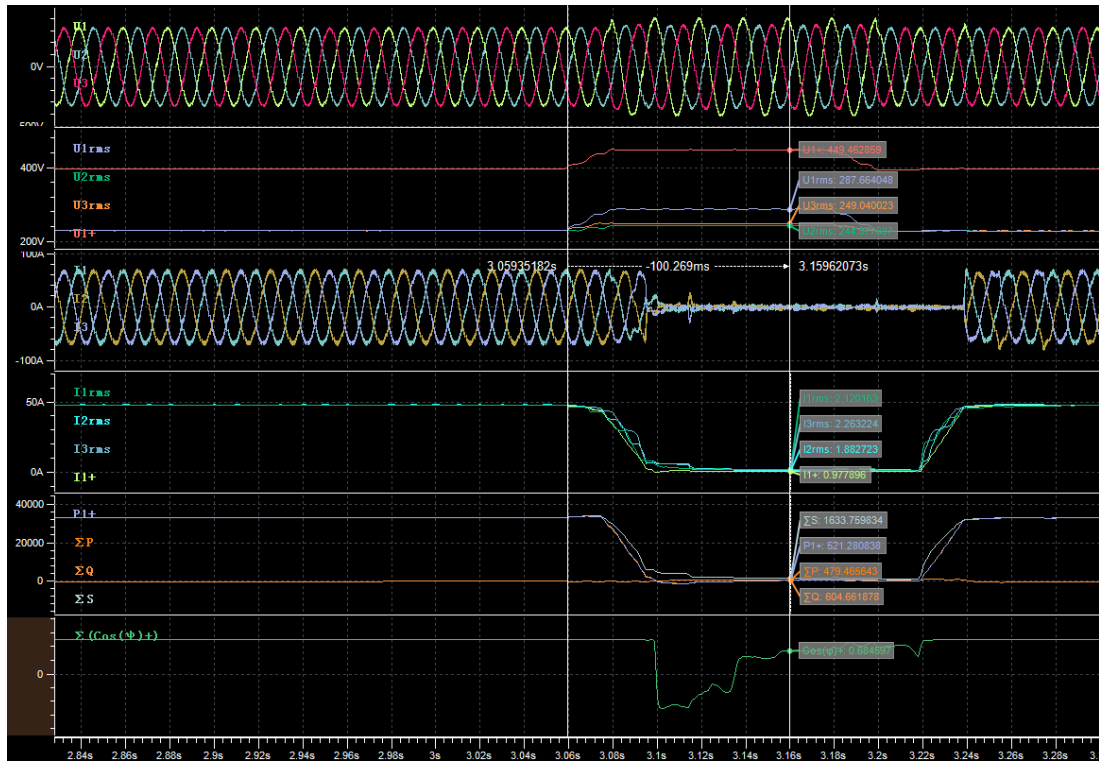

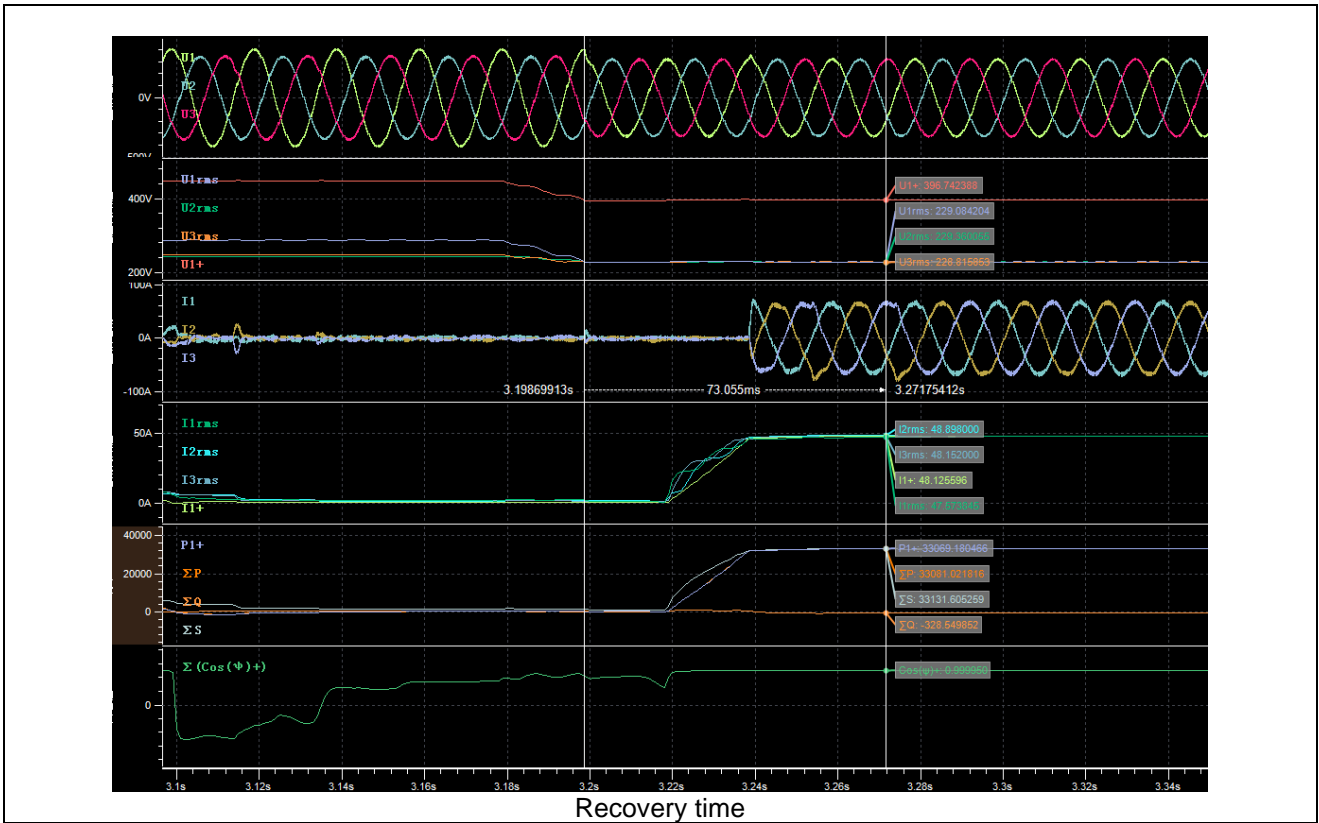

**E.5 Test report “Network interactions” for power generation units with an input current > 75 A**

System manufacturer (Herstellerangaben):	System type (Anlagenart) (BHKW, PV-WR, ...)		PV			
	Max. active power P <sub>E</sub> max (maximale Wirkleistung P <sub>E</sub> max)	SOFAR 20000TL-G2	SOFAR 25000TL-G2			
		20.068KW	25.532KW			
		SOFAR 30000TL-G2	SOFAR 33000TL-G2			
		30.442KW	30.083KW			
Rated voltage (Bemessungsspannung)		3W/N/PE 230Vac/400Vac				
Measurement period (Messzeitraum)	From (vom) JJJJ-MM-TT to (bis) JJJJ-MM-TT		2020-Jan-09 to 2020-Jun-04			
Rapid voltage changes (Schnelle Spannungsänderungen)			ki = 0.16			
Connection without provisions (regarding the primary energy carrier) (Einschalten ohne Vorgabe (zum Primärenergieträger))			ki = 0.05			
Most adverse case when switching between generator levels (Ungünstigster Fall beim Umschalten der Generatorstufen)			ki = 0.05			
Connection at nominal conditions (of the primary energy carrier) (Einschalten bei Nennbedingungen (des Primärenergieträgers))			ki = 0.16			
Disconnection at rated power (Ausschalten bei Bemessungsleistung)			ki = 0.16			
Worst value of all switching operations (Schlechtester Wert aller Schaltvorgänge)			kimax = 0.16			
Flicker	Network impedance angle $\Psi_k$ (Netzimpedanzwinkel $\Psi_k$ )	30°	50°	70°	85°	
	Initial flicker factor $c_\Psi$ (Anlagenflickerbeiwert $c_\Psi$ )	3.06	2.01	1.63	1.53	



Model: SOFAR 20000TL-G2										
Active power (Wirkleistung) $P/P_n$ [%]	10	20	30	40	50	60	70	80	90	100
Ordinal number (Ordnungszahl)	I [%]	I [%]	I [%]	I [%]	I [%]	I [%]	I [%]	I [%]	I [%]	I [%]
2	0.069	0.074	0.051	0.064	0.095	0.119	0.116	0.114	0.116	0.117
3	0.109	0.136	0.106	0.104	0.131	0.158	0.155	0.153	0.142	0.128
4	0.045	0.057	0.034	0.043	0.051	0.064	0.064	0.066	0.070	0.086
5	0.425	0.213	0.118	0.066	0.103	0.188	0.244	0.306	0.338	0.345
6	0.044	0.035	0.018	0.020	0.028	0.022	0.021	0.023	0.029	0.034
7	0.521	0.206	0.097	0.045	0.084	0.167	0.232	0.308	0.345	0.358
8	0.039	0.028	0.020	0.023	0.035	0.033	0.031	0.030	0.029	0.038
9	0.069	0.080	0.079	0.062	0.037	0.035	0.033	0.046	0.041	0.052
10	0.023	0.022	0.017	0.013	0.037	0.041	0.045	0.048	0.046	0.047
11	0.669	0.359	0.169	0.104	0.095	0.153	0.197	0.240	0.279	0.307
12	0.028	0.009	0.015	0.019	0.028	0.031	0.039	0.046	0.049	0.049
13	0.433	0.278	0.156	0.109	0.113	0.158	0.209	0.254	0.286	0.301
14	0.019	0.012	0.012	0.014	0.030	0.047	0.052	0.055	0.051	0.049
15	0.034	0.028	0.029	0.029	0.031	0.035	0.029	0.030	0.029	0.032
16	0.027	0.017	0.007	0.013	0.026	0.028	0.030	0.032	0.030	0.029
17	0.280	0.235	0.171	0.121	0.094	0.089	0.090	0.090	0.113	0.133
18	0.014	0.015	0.006	0.007	0.005	0.011	0.013	0.015	0.017	0.018
19	0.175	0.133	0.136	0.119	0.092	0.074	0.082	0.084	0.098	0.120
20	0.013	0.014	0.011	0.011	0.021	0.024	0.020	0.019	0.017	0.019
21	0.037	0.023	0.014	0.017	0.012	0.012	0.013	0.014	0.014	0.018
22	0.012	0.012	0.005	0.008	0.012	0.017	0.018	0.016	0.015	0.016
23	0.177	0.043	0.088	0.103	0.083	0.067	0.053	0.054	0.068	0.078
24	0.010	0.008	0.004	0.007	0.009	0.006	0.006	0.007	0.007	0.007
25	0.131	0.047	0.054	0.090	0.088	0.082	0.078	0.075	0.084	0.090
26	0.010	0.009	0.008	0.007	0.008	0.009	0.009	0.013	0.013	0.013
27	0.016	0.019	0.012	0.010	0.010	0.012	0.013	0.014	0.014	0.015
28	0.008	0.009	0.005	0.006	0.007	0.010	0.009	0.010	0.012	0.011
29	0.087	0.085	0.018	0.062	0.070	0.068	0.064	0.062	0.064	0.070
30	0.009	0.005	0.004	0.004	0.006	0.004	0.005	0.006	0.008	0.007
31	0.062	0.102	0.027	0.052	0.074	0.071	0.060	0.057	0.060	0.070
32	0.011	0.005	0.004	0.009	0.006	0.009	0.011	0.014	0.014	0.015
33	0.017	0.016	0.009	0.013	0.009	0.009	0.010	0.012	0.012	0.012
34	0.011	0.006	0.004	0.006	0.005	0.006	0.008	0.010	0.011	0.011
35	0.044	0.102	0.030	0.035	0.059	0.062	0.050	0.039	0.043	0.051
36	0.007	0.004	0.004	0.004	0.004	0.005	0.004	0.006	0.006	0.006
37	0.049	0.092	0.030	0.018	0.047	0.070	0.067	0.066	0.068	0.071
38	0.009	0.003	0.004	0.007	0.005	0.007	0.006	0.009	0.010	0.010
39	0.010	0.012	0.007	0.012	0.006	0.008	0.008	0.010	0.011	0.011
40	0.008	0.004	0.004	0.005	0.005	0.005	0.006	0.008	0.009	0.009

Inter-harmonics (Zwischenharmonische)										
Active power (Wirkleistung) $P/P_n$ [%]	10	20	30	40	50	60	70	80	90	100
Frequenz (Frequency) [kHz]	I [%]	I [%]	I [%]	I [%]	I [%]	I [%]	I [%]	I [%]	I [%]	I [%]
75	0.007	0.005	0.005	0.004	0.004	0.005	0.005	0.006	0.006	0.007
125	0.018	0.016	0.016	0.018	0.018	0.017	0.017	0.018	0.019	0.020
175	0.006	0.005	0.005	0.004	0.006	0.006	0.006	0.007	0.009	0.011
225	0.008	0.005	0.005	0.005	0.005	0.005	0.006	0.006	0.007	0.007
275	0.007	0.006	0.006	0.006	0.006	0.007	0.006	0.008	0.010	0.012
325	0.008	0.006	0.006	0.006	0.007	0.009	0.009	0.010	0.011	0.014
375	0.014	0.011	0.012	0.012	0.012	0.011	0.011	0.013	0.013	0.014
425	0.013	0.012	0.013	0.014	0.014	0.015	0.015	0.014	0.021	0.024
475	0.012	0.012	0.013	0.013	0.015	0.017	0.016	0.019	0.021	0.021
525	0.008	0.008	0.008	0.009	0.010	0.010	0.012	0.014	0.014	0.017
575	0.006	0.006	0.006	0.006	0.007	0.007	0.007	0.008	0.009	0.012
625	0.005	0.005	0.005	0.005	0.006	0.006	0.006	0.006	0.006	0.007
675	0.004	0.004	0.004	0.004	0.004	0.004	0.004	0.005	0.005	0.005
725	0.003	0.003	0.004	0.004	0.004	0.004	0.004	0.004	0.005	0.004
775	0.003	0.003	0.003	0.003	0.004	0.004	0.004	0.003	0.004	0.004
825	0.003	0.003	0.003	0.003	0.003	0.003	0.004	0.003	0.004	0.003
875	0.002	0.002	0.003	0.003	0.003	0.003	0.003	0.003	0.003	0.003
925	0.002	0.002	0.003	0.003	0.003	0.003	0.003	0.002	0.003	0.003
975	0.002	0.002	0.002	0.002	0.003	0.002	0.003	0.002	0.003	0.002
1025	0.002	0.002	0.002	0.002	0.003	0.002	0.002	0.002	0.003	0.002
1075	0.002	0.002	0.002	0.002	0.003	0.002	0.002	0.002	0.003	0.002
1125	0.002	0.002	0.002	0.002	0.002	0.002	0.002	0.002	0.003	0.002
1175	0.002	0.002	0.002	0.002	0.002	0.002	0.002	0.002	0.003	0.002
1225	0.002	0.002	0.002	0.002	0.002	0.002	0.002	0.002	0.003	0.003
1275	0.002	0.002	0.002	0.002	0.002	0.002	0.002	0.002	0.002	0.002
1325	0.002	0.002	0.002	0.002	0.002	0.002	0.002	0.002	0.003	0.002
1375	0.002	0.002	0.002	0.002	0.002	0.002	0.002	0.002	0.003	0.002
1425	0.002	0.002	0.002	0.002	0.002	0.002	0.002	0.002	0.002	0.002
1475	0.002	0.002	0.002	0.002	0.002	0.002	0.002	0.002	0.003	0.002
1525	0.002	0.002	0.002	0.002	0.002	0.002	0.002	0.002	0.003	0.002
1575	0.002	0.002	0.002	0.002	0.002	0.002	0.002	0.002	0.003	0.002
1625	0.002	0.002	0.002	0.002	0.002	0.002	0.002	0.002	0.003	0.002
1675	0.002	0.002	0.002	0.002	0.002	0.002	0.002	0.002	0.003	0.002
1725	0.002	0.002	0.002	0.002	0.002	0.002	0.002	0.002	0.003	0.002
1775	0.002	0.002	0.002	0.002	0.002	0.002	0.002	0.002	0.003	0.003
1825	0.007	0.005	0.005	0.004	0.004	0.005	0.005	0.006	0.006	0.007
1875	0.018	0.016	0.016	0.018	0.018	0.017	0.017	0.018	0.019	0.020
1925	0.006	0.005	0.005	0.004	0.006	0.006	0.006	0.007	0.009	0.011
1975	0.008	0.005	0.005	0.005	0.005	0.005	0.006	0.006	0.007	0.007

Higher frequencies (Höhere Frequenzen)										
Active power (Wirkleistung) $P/P_n$ [%]	10	20	30	40	50	60	70	80	90	100
Frequenz (Frequency) [kHz]	I [%]	I [%]	I [%]	I [%]	I [%]	I [%]	I [%]	I [%]	I [%]	I [%]
2.1	0.019	0.022	0.020	0.020	0.021	0.023	0.023	0.026	0.027	0.030
2.3	0.026	0.030	0.031	0.032	0.033	0.032	0.030	0.030	0.029	0.030
2.5	0.029	0.031	0.030	0.031	0.034	0.034	0.034	0.034	0.033	0.033
2.7	0.028	0.031	0.033	0.034	0.035	0.033	0.033	0.034	0.034	0.033
2.9	0.030	0.031	0.033	0.032	0.034	0.035	0.036	0.036	0.037	0.037
3.1	0.027	0.025	0.027	0.027	0.027	0.028	0.030	0.034	0.033	0.034
3.3	0.023	0.019	0.021	0.020	0.021	0.022	0.025	0.028	0.027	0.031
3.5	0.023	0.021	0.022	0.022	0.022	0.022	0.023	0.024	0.026	0.028
3.7	0.020	0.016	0.017	0.016	0.016	0.017	0.018	0.022	0.024	0.026
3.9	0.019	0.015	0.017	0.015	0.015	0.015	0.016	0.018	0.018	0.020
4.1	0.018	0.015	0.013	0.014	0.015	0.017	0.018	0.018	0.020	0.022
4.3	0.016	0.012	0.011	0.011	0.011	0.011	0.013	0.015	0.016	0.018
4.5	0.015	0.012	0.011	0.012	0.011	0.012	0.013	0.014	0.015	0.016
4.7	0.039	0.040	0.039	0.040	0.043	0.045	0.050	0.054	0.059	0.067
4.9	0.019	0.017	0.018	0.018	0.016	0.019	0.016	0.018	0.018	0.016
5.1	0.015	0.013	0.012	0.012	0.012	0.011	0.011	0.012	0.013	0.015
5.3	0.012	0.010	0.009	0.008	0.009	0.010	0.013	0.014	0.014	0.016
5.5	0.011	0.008	0.008	0.008	0.008	0.008	0.008	0.010	0.011	0.011
5.7	0.010	0.008	0.008	0.007	0.007	0.008	0.008	0.009	0.010	0.011
5.9	0.010	0.008	0.008	0.007	0.007	0.008	0.008	0.009	0.009	0.010
6.1	0.009	0.007	0.007	0.007	0.007	0.007	0.007	0.008	0.009	0.009
6.3	0.009	0.007	0.006	0.006	0.006	0.007	0.007	0.008	0.008	0.009
6.5	0.008	0.007	0.006	0.006	0.006	0.006	0.007	0.007	0.008	0.008
6.7	0.008	0.006	0.006	0.006	0.006	0.006	0.006	0.007	0.007	0.008
6.9	0.008	0.006	0.006	0.006	0.006	0.005	0.006	0.006	0.007	0.008
7.1	0.008	0.006	0.007	0.006	0.006	0.007	0.007	0.007	0.008	0.008
7.3	0.007	0.006	0.006	0.006	0.005	0.005	0.006	0.006	0.007	0.008
7.5	0.011	0.010	0.011	0.011	0.011	0.011	0.013	0.013	0.014	0.009
7.7	0.006	0.006	0.005	0.005	0.005	0.005	0.006	0.006	0.006	0.007
7.9	0.006	0.005	0.005	0.005	0.005	0.005	0.006	0.006	0.006	0.007
8.1	0.006	0.006	0.005	0.005	0.005	0.005	0.005	0.006	0.006	0.007
8.3	0.006	0.005	0.005	0.005	0.005	0.005	0.006	0.006	0.006	0.007
8.5	0.006	0.005	0.005	0.005	0.005	0.005	0.005	0.006	0.006	0.007
8.7	0.006	0.005	0.005	0.005	0.005	0.005	0.005	0.006	0.005	0.006
8.9	0.006	0.005	0.005	0.005	0.005	0.005	0.005	0.006	0.005	0.006

Model: SOFAR 25000TL-G2										
Active power (Wirkleistung) $P/P_n$ [%]	10	20	30	40	50	60	70	80	90	100
Ordinal number (Ordnungszahl)	I [%]	I [%]	I [%]	I [%]	I [%]	I [%]	I [%]	I [%]	I [%]	I [%]
2	0.054	0.051	0.052	0.052	0.057	0.066	0.069	0.074	0.081	0.081
3	0.109	0.077	0.097	0.107	0.125	0.164	0.182	0.206	0.220	0.227
4	0.018	0.021	0.030	0.039	0.041	0.037	0.032	0.029	0.028	0.032
5	0.169	0.057	0.090	0.162	0.282	0.457	0.557	0.658	0.734	0.801
6	0.013	0.012	0.013	0.014	0.012	0.010	0.011	0.013	0.012	0.014
7	0.181	0.059	0.076	0.136	0.267	0.443	0.547	0.648	0.724	0.790
8	0.012	0.015	0.017	0.017	0.013	0.011	0.011	0.012	0.014	0.014
9	0.045	0.054	0.055	0.064	0.079	0.100	0.103	0.107	0.105	0.113
10	0.014	0.011	0.006	0.007	0.018	0.023	0.025	0.026	0.030	0.028
11	0.349	0.199	0.110	0.116	0.177	0.238	0.277	0.317	0.340	0.364
12	0.011	0.006	0.005	0.010	0.009	0.010	0.011	0.012	0.012	0.010
13	0.308	0.167	0.111	0.103	0.096	0.148	0.181	0.207	0.226	0.244
14	0.007	0.005	0.006	0.010	0.014	0.017	0.018	0.020	0.021	0.021
15	0.041	0.014	0.034	0.027	0.041	0.038	0.038	0.036	0.033	0.036
16	0.008	0.007	0.005	0.009	0.013	0.010	0.008	0.009	0.009	0.009
17	0.319	0.199	0.149	0.117	0.116	0.127	0.151	0.183	0.207	0.221
18	0.009	0.007	0.005	0.003	0.003	0.005	0.005	0.006	0.005	0.006
19	0.231	0.153	0.124	0.105	0.094	0.109	0.120	0.142	0.167	0.187
20	0.006	0.004	0.003	0.003	0.004	0.004	0.004	0.003	0.004	0.005
21	0.016	0.009	0.019	0.015	0.012	0.014	0.011	0.017	0.016	0.020
22	0.005	0.003	0.003	0.004	0.004	0.004	0.004	0.005	0.005	0.005
23	0.144	0.105	0.105	0.094	0.088	0.073	0.082	0.094	0.102	0.113
24	0.008	0.004	0.004	0.004	0.004	0.004	0.003	0.004	0.005	0.004
25	0.079	0.081	0.074	0.080	0.081	0.079	0.081	0.096	0.104	0.106
26	0.004	0.003	0.004	0.004	0.003	0.003	0.004	0.006	0.005	0.007
27	0.013	0.018	0.010	0.012	0.015	0.017	0.013	0.011	0.014	0.017
28	0.003	0.002	0.002	0.002	0.005	0.004	0.005	0.005	0.005	0.005
29	0.023	0.047	0.044	0.061	0.066	0.079	0.081	0.089	0.097	0.104
30	0.003	0.002	0.002	0.003	0.003	0.002	0.002	0.002	0.002	0.003
31	0.021	0.042	0.025	0.052	0.060	0.069	0.069	0.070	0.076	0.083
32	0.003	0.002	0.004	0.003	0.003	0.003	0.002	0.002	0.003	0.003
33	0.012	0.013	0.010	0.012	0.013	0.008	0.009	0.011	0.010	0.013
34	0.003	0.002	0.002	0.002	0.003	0.002	0.002	0.003	0.003	0.003
35	0.019	0.046	0.010	0.040	0.055	0.062	0.060	0.064	0.064	0.068
36	0.002	0.002	0.002	0.002	0.003	0.002	0.002	0.002	0.002	0.002
37	0.029	0.063	0.008	0.020	0.038	0.057	0.060	0.074	0.076	0.073
38	0.003	0.002	0.002	0.003	0.003	0.002	0.002	0.002	0.002	0.002
39	0.009	0.009	0.007	0.015	0.007	0.006	0.008	0.010	0.010	0.013
40	0.002	0.002	0.002	0.002	0.003	0.002	0.002	0.002	0.004	0.004

Inter-harmonics (Zwischenharmonische)										
Active power (Wirkleistung) $P/P_n$ [%]	10	20	30	40	50	60	70	80	90	100
Frequenz (Frequency) [kHz]	I [%]	I [%]	I [%]	I [%]	I [%]	I [%]	I [%]	I [%]	I [%]	I [%]
75	0.024	0.023	0.022	0.020	0.020	0.020	0.022	0.022	0.023	0.025
125	0.034	0.037	0.038	0.035	0.034	0.032	0.032	0.033	0.032	0.035
175	0.035	0.035	0.038	0.037	0.038	0.038	0.038	0.038	0.037	0.036
225	0.035	0.034	0.036	0.036	0.036	0.037	0.038	0.038	0.038	0.039
275	0.028	0.029	0.031	0.030	0.031	0.032	0.036	0.037	0.039	0.040
325	0.027	0.024	0.024	0.024	0.024	0.025	0.029	0.031	0.034	0.036
375	0.022	0.018	0.018	0.019	0.018	0.019	0.022	0.026	0.027	0.030
425	0.018	0.016	0.015	0.015	0.016	0.017	0.019	0.021	0.023	0.026
475	0.017	0.015	0.014	0.014	0.015	0.014	0.016	0.019	0.020	0.022
525	0.016	0.012	0.011	0.010	0.011	0.011	0.013	0.014	0.015	0.017
575	0.013	0.010	0.010	0.010	0.011	0.012	0.013	0.014	0.015	0.019
625	0.014	0.010	0.010	0.010	0.010	0.009	0.010	0.012	0.012	0.013
675	0.012	0.008	0.008	0.008	0.008	0.008	0.010	0.010	0.011	0.012
725	0.011	0.007	0.008	0.008	0.008	0.008	0.008	0.010	0.010	0.011
775	0.010	0.007	0.007	0.007	0.008	0.007	0.008	0.009	0.010	0.011
825	0.011	0.007	0.006	0.006	0.007	0.008	0.009	0.008	0.010	0.012
875	0.010	0.007	0.007	0.008	0.009	0.008	0.009	0.010	0.011	0.011
925	0.010	0.008	0.008	0.008	0.008	0.007	0.008	0.009	0.009	0.010
975	0.009	0.007	0.006	0.006	0.006	0.007	0.007	0.008	0.008	0.009
1025	0.008	0.007	0.006	0.006	0.007	0.007	0.007	0.008	0.008	0.009
1075	0.007	0.006	0.005	0.006	0.006	0.006	0.006	0.007	0.007	0.008
1125	0.008	0.005	0.005	0.005	0.005	0.005	0.006	0.006	0.006	0.008
1175	0.007	0.005	0.005	0.005	0.005	0.005	0.006	0.006	0.006	0.007
1225	0.007	0.006	0.006	0.007	0.007	0.009	0.009	0.009	0.010	0.011
1275	0.007	0.005	0.005	0.005	0.006	0.006	0.007	0.008	0.009	0.011
1325	0.007	0.006	0.006	0.006	0.006	0.006	0.007	0.008	0.008	0.010
1375	0.006	0.005	0.005	0.005	0.005	0.005	0.006	0.007	0.008	0.010
1425	0.006	0.006	0.005	0.005	0.006	0.005	0.006	0.006	0.007	0.007
1475	0.005	0.005	0.004	0.004	0.005	0.005	0.005	0.006	0.005	0.006
1525	0.005	0.005	0.004	0.004	0.005	0.005	0.005	0.006	0.005	0.006
1575	0.005	0.005	0.005	0.005	0.005	0.005	0.006	0.006	0.006	0.007
1625	0.005	0.005	0.004	0.004	0.005	0.005	0.005	0.006	0.005	0.006
1675	0.004	0.005	0.005	0.004	0.005	0.005	0.005	0.006	0.005	0.006
1725	0.005	0.004	0.004	0.004	0.004	0.004	0.005	0.005	0.005	0.005
1775	0.004	0.004	0.004	0.004	0.004	0.004	0.005	0.005	0.005	0.006
1825	0.004	0.004	0.004	0.004	0.004	0.004	0.004	0.005	0.005	0.005
1875	0.004	0.004	0.004	0.004	0.004	0.004	0.004	0.005	0.005	0.005
1925	0.004	0.004	0.004	0.004	0.004	0.004	0.004	0.005	0.005	0.005
1975	0.004	0.004	0.004	0.004	0.004	0.004	0.004	0.005	0.005	0.005

Higher frequencies (Höhere Frequenzen)										
Active power (Wirkleistung) $P/P_n$ [%]	10	20	30	40	50	60	70	80	90	100
Frequenz (Frequency) [kHz]	I [%]	I [%]	I [%]	I [%]	I [%]	I [%]	I [%]	I [%]	I [%]	I [%]
2.1	0.003	0.003	0.003	0.004	0.003	0.003	0.003	0.004	0.004	0.004
2.3	0.014	0.014	0.014	0.014	0.015	0.014	0.014	0.014	0.014	0.015
2.5	0.004	0.003	0.003	0.004	0.004	0.004	0.004	0.004	0.005	0.005
2.7	0.005	0.003	0.003	0.004	0.004	0.004	0.004	0.004	0.004	0.004
2.9	0.005	0.004	0.004	0.004	0.004	0.004	0.004	0.005	0.005	0.005
3.1	0.005	0.005	0.005	0.005	0.005	0.005	0.006	0.006	0.005	0.006
3.3	0.009	0.008	0.008	0.008	0.008	0.008	0.008	0.008	0.008	0.008
3.5	0.009	0.009	0.009	0.010	0.011	0.011	0.011	0.010	0.011	0.010
3.7	0.009	0.008	0.009	0.010	0.011	0.012	0.012	0.013	0.014	0.011
3.9	0.014	0.016	0.017	0.018	0.019	0.020	0.020	0.022	0.023	0.024
4.1	0.015	0.015	0.016	0.016	0.017	0.017	0.018	0.019	0.021	0.021
4.3	0.005	0.004	0.004	0.004	0.005	0.004	0.004	0.005	0.005	0.005
4.5	0.004	0.003	0.003	0.004	0.004	0.004	0.004	0.004	0.004	0.004
4.7	0.003	0.003	0.003	0.003	0.004	0.004	0.004	0.003	0.004	0.004
4.9	0.002	0.003	0.003	0.003	0.003	0.003	0.003	0.003	0.003	0.003
5.1	0.002	0.002	0.003	0.002	0.003	0.002	0.003	0.002	0.003	0.003
5.3	0.002	0.002	0.002	0.002	0.003	0.002	0.003	0.002	0.003	0.003
5.5	0.002	0.002	0.002	0.002	0.003	0.002	0.002	0.002	0.003	0.003
5.7	0.002	0.002	0.002	0.002	0.002	0.002	0.002	0.002	0.002	0.002
5.9	0.002	0.002	0.002	0.002	0.002	0.002	0.002	0.002	0.002	0.002
6.1	0.002	0.002	0.002	0.002	0.002	0.002	0.002	0.002	0.002	0.002
6.3	0.002	0.002	0.002	0.002	0.002	0.002	0.002	0.002	0.002	0.002
6.5	0.002	0.002	0.002	0.002	0.002	0.002	0.002	0.002	0.002	0.002
6.7	0.001	0.002	0.002	0.002	0.002	0.002	0.001	0.002	0.002	0.002
6.9	0.001	0.001	0.002	0.002	0.002	0.002	0.001	0.002	0.002	0.002
7.1	0.002	0.002	0.002	0.002	0.002	0.002	0.002	0.002	0.002	0.002
7.3	0.001	0.001	0.002	0.002	0.002	0.002	0.001	0.002	0.002	0.002
7.5	0.001	0.001	0.002	0.002	0.002	0.002	0.001	0.002	0.002	0.002
7.7	0.001	0.001	0.002	0.002	0.002	0.001	0.001	0.002	0.002	0.002
7.9	0.001	0.001	0.002	0.002	0.002	0.002	0.001	0.002	0.002	0.002
8.1	0.002	0.002	0.002	0.002	0.002	0.002	0.002	0.002	0.003	0.002
8.3	0.001	0.001	0.002	0.002	0.002	0.001	0.001	0.002	0.002	0.002
8.5	0.001	0.001	0.002	0.002	0.002	0.002	0.001	0.002	0.002	0.001
8.7	0.001	0.001	0.002	0.002	0.002	0.001	0.001	0.002	0.002	0.001
8.9	0.001	0.001	0.002	0.002	0.002	0.001	0.001	0.002	0.002	0.002

Model: SOFAR 30000TL-G2										
Active power (Wirkleistung) $P/P_n$ [%]	10	20	30	40	50	60	70	80	90	100
Ordinal number (Ordnungszahl)	I [%]	I [%]	I [%]	I [%]	I [%]	I [%]	I [%]	I [%]	I [%]	I [%]
2	0.0373	0.0367	0.0440	0.0475	0.0572	0.0580	0.0612	0.0507	0.0425	0.0408
3	0.1002	0.0626	0.0734	0.0950	0.1508	0.1288	0.1796	0.1457	0.1591	0.1418
4	0.0023	0.0111	0.0244	0.0305	0.0178	0.0261	0.0250	0.0305	0.0276	0.0347
5	0.1335	0.0278	0.1108	0.2365	0.3934	0.4113	0.5111	0.5119	0.5950	0.6189
6	0.0081	0.0096	0.0077	0.0046	0.0101	0.0068	0.0100	0.0126	0.0093	0.0096
7	0.1063	0.0399	0.1044	0.2324	0.3383	0.4522	0.5233	0.5489	0.5887	0.6217
8	0.0059	0.0033	0.0079	0.0077	0.0070	0.0095	0.0132	0.0039	0.0061	0.0188
9	0.0559	0.0167	0.0531	0.0683	0.0859	0.0925	0.1075	0.0691	0.0981	0.0873
10	0.0146	0.0035	0.0027	0.0149	0.0187	0.0140	0.0165	0.0191	0.0215	0.0216
11	0.2485	0.1338	0.0991	0.1561	0.2016	0.2758	0.2968	0.3258	0.3403	0.3732
12	0.0096	0.0040	0.0067	0.0034	0.0074	0.0053	0.0031	0.0042	0.0062	0.0024
13	0.2297	0.1010	0.0902	0.0807	0.1340	0.1948	0.1937	0.2283	0.2371	0.2629
14	0.0040	0.0062	0.0071	0.0106	0.0139	0.0170	0.0093	0.0117	0.0141	0.0177
15	0.0084	0.0190	0.0204	0.0464	0.0533	0.0144	0.0274	0.0220	0.0305	0.0248
16	0.0031	0.0022	0.0047	0.0101	0.0081	0.0079	0.0091	0.0056	0.0050	0.0076
17	0.2342	0.1253	0.0952	0.0761	0.0836	0.1219	0.1449	0.1635	0.1520	0.1453
18	0.0036	0.0080	0.0025	0.0024	0.0045	0.0046	0.0071	0.0039	0.0028	0.0036
19	0.1733	0.0979	0.0819	0.0665	0.0783	0.1026	0.1233	0.1563	0.1448	0.1508
20	0.0047	0.0012	0.0020	0.0009	0.0031	0.0053	0.0011	0.0018	0.0047	0.0071
21	0.0041	0.0119	0.0059	0.0138	0.0111	0.0209	0.0099	0.0143	0.0100	0.0077
22	0.0005	0.0024	0.0035	0.0016	0.0019	0.0031	0.0016	0.0042	0.0029	0.0031
23	0.1132	0.0675	0.0704	0.0600	0.0511	0.0826	0.0820	0.1073	0.1038	0.1172
24	0.0016	0.0026	0.0022	0.0023	0.0020	0.0027	0.0012	0.0017	0.0011	0.0011
25	0.0782	0.0430	0.0601	0.0592	0.0580	0.0717	0.0776	0.0803	0.0837	0.0929
26	0.0030	0.0046	0.0029	0.0025	0.0032	0.0030	0.0024	0.0030	0.0035	0.0062
27	0.0152	0.0135	0.0077	0.0159	0.0283	0.0095	0.0134	0.0063	0.0229	0.0196
28	0.0009	0.0027	0.0010	0.0043	0.0016	0.0037	0.0052	0.0028	0.0054	0.0048
29	0.0553	0.0141	0.0435	0.0510	0.0540	0.0675	0.0702	0.0851	0.0724	0.0682
30	0.0020	0.0008	0.0031	0.0016	0.0010	0.0021	0.0022	0.0026	0.0009	0.0011
31	0.0716	0.0161	0.0414	0.0516	0.0514	0.0522	0.0636	0.0758	0.0734	0.0789
32	0.0006	0.0032	0.0037	0.0007	0.0036	0.0017	0.0012	0.0014	0.0031	0.0023
33	0.0212	0.0128	0.0084	0.0106	0.0108	0.0194	0.0051	0.0128	0.0057	0.0099
34	0.0020	0.0008	0.0023	0.0020	0.0006	0.0007	0.0022	0.0022	0.0018	0.0021
35	0.0707	0.0145	0.0247	0.0440	0.0419	0.0512	0.0515	0.0645	0.0615	0.0692
36	0.0014	0.0023	0.0009	0.0011	0.0010	0.0009	0.0011	0.0044	0.0008	0.0022
37	0.0710	0.0127	0.0138	0.0405	0.0467	0.0511	0.0570	0.0611	0.0585	0.0633
38	0.0011	0.0019	0.0039	0.0016	0.0012	0.0027	0.0013	0.0017	0.0015	0.0040
39	0.0098	0.0042	0.0134	0.0042	0.0132	0.0072	0.0051	0.0034	0.0142	0.0125
40	0.0014	0.0009	0.0008	0.0027	0.0013	0.0013	0.0020	0.0031	0.0036	0.0034

Inter-harmonics (Zwischenharmonische)										
Active power (Wirkleistung) $P/P_n$ [%]	10	20	30	40	50	60	70	80	90	100
Frequenz (Frequency) [kHz]	I [%]	I [%]	I [%]	I [%]	I [%]	I [%]	I [%]	I [%]	I [%]	I [%]
75	0.1629	0.2448	0.2560	0.2524	0.2507	0.2438	0.2415	0.1341	0.0550	0.0346
125	0.0868	0.0975	0.0874	0.0863	0.0737	0.0743	0.0722	0.0491	0.0390	0.0398
175	0.2262	0.2139	0.2274	0.2578	0.2719	0.2781	0.2831	0.2809	0.1037	0.0316
225	0.0806	0.1025	0.0905	0.0936	0.0829	0.0818	0.0807	0.0661	0.0496	0.0964
275	0.1328	0.1746	0.1803	0.1892	0.1977	0.2013	0.2031	0.2005	0.1088	0.0352
325	0.0297	0.0363	0.0329	0.0369	0.0356	0.0406	0.0433	0.0375	0.0330	0.1299
375	0.0384	0.0439	0.0464	0.0516	0.0465	0.0496	0.0520	0.0664	0.0430	0.0239
425	0.0287	0.0315	0.0262	0.0274	0.0277	0.0299	0.0329	0.0288	0.0218	0.0563
475	0.0293	0.0337	0.0292	0.0267	0.0237	0.0258	0.0271	0.0327	0.0244	0.0189
525	0.0209	0.0191	0.0188	0.0198	0.0187	0.0195	0.0213	0.0176	0.0155	0.0301
575	0.0183	0.0213	0.0199	0.0190	0.0180	0.0182	0.0185	0.0175	0.0155	0.0145
625	0.0150	0.0164	0.0170	0.0185	0.0200	0.0225	0.0251	0.0155	0.0117	0.0164
675	0.0161	0.0163	0.0162	0.0156	0.0147	0.0162	0.0173	0.0181	0.0193	0.0121
725	0.0149	0.0150	0.0189	0.0195	0.0193	0.0197	0.0194	0.0169	0.0119	0.0213
775	0.0144	0.0150	0.0164	0.0153	0.0141	0.0157	0.0177	0.0167	0.0188	0.0107
825	0.0148	0.0119	0.0128	0.0138	0.0123	0.0131	0.0147	0.0131	0.0102	0.0222
875	0.0107	0.0113	0.0123	0.0116	0.0109	0.0116	0.0126	0.0119	0.0143	0.0095
925	0.0115	0.0100	0.0096	0.0106	0.0094	0.0103	0.0111	0.0108	0.0095	0.0155
975	0.0100	0.0099	0.0107	0.0102	0.0092	0.0101	0.0110	0.0097	0.0093	0.0084
1025	0.0117	0.0107	0.0099	0.0097	0.0095	0.0100	0.0110	0.0103	0.0082	0.0102
1075	0.0089	0.0095	0.0109	0.0105	0.0098	0.0100	0.0110	0.0096	0.0079	0.0072
1125	0.1629	0.2448	0.2560	0.2524	0.2507	0.2438	0.2415	0.1341	0.0550	0.0346
1175	0.0868	0.0975	0.0874	0.0863	0.0737	0.0743	0.0722	0.0491	0.0390	0.0398
1225	0.0040	0.0050	0.0040	0.0040	0.0060	0.0070	0.0070	0.0070	0.0070	0.0080
1275	0.0050	0.0040	0.0050	0.0050	0.0060	0.0070	0.0080	0.0090	0.0120	0.0160
1325	0.0040	0.0040	0.0040	0.0040	0.0050	0.0050	0.0060	0.0070	0.0090	0.0120
1375	0.0040	0.0040	0.0040	0.0040	0.0050	0.0050	0.0070	0.0090	0.0110	0.0150
1425	0.0040	0.0040	0.0040	0.0040	0.0050	0.0050	0.0060	0.0060	0.0060	0.0080
1475	0.0040	0.0030	0.0030	0.0030	0.0040	0.0040	0.0040	0.0050	0.0050	0.0060
1525	0.0040	0.0030	0.0030	0.0030	0.0040	0.0040	0.0040	0.0040	0.0050	0.0050
1575	0.0040	0.0030	0.0030	0.0040	0.0040	0.0040	0.0050	0.0050	0.0050	0.0060
1625	0.0040	0.0030	0.0030	0.0030	0.0040	0.0040	0.0040	0.0040	0.0050	0.0050
1675	0.0040	0.0030	0.0030	0.0040	0.0040	0.0040	0.0040	0.0040	0.0050	0.0050
1725	0.0040	0.0030	0.0030	0.0030	0.0040	0.0040	0.0040	0.0040	0.0050	0.0050
1775	0.0040	0.0030	0.0030	0.0030	0.0040	0.0040	0.0040	0.0040	0.0050	0.0040
1825	0.0030	0.0030	0.0030	0.0030	0.0040	0.0040	0.0040	0.0040	0.0040	0.0040
1875	0.0030	0.0030	0.0030	0.0030	0.0030	0.0040	0.0040	0.0040	0.0040	0.0040
1925	0.0030	0.0030	0.0030	0.0030	0.0040	0.0040	0.0040	0.0040	0.0040	0.0040
1975	0.0030	0.0030	0.0030	0.0030	0.0030	0.0040	0.0040	0.0030	0.0040	0.0040



Higher frequencies (Höhere Frequenzen)										
Active power (Wirkleistung) $P/P_n$ [%]	10	20	30	40	50	60	70	80	90	100
Frequenz (Frequency) [kHz]	I [%]	I [%]	I [%]	I [%]	I [%]	I [%]	I [%]	I [%]	I [%]	I [%]
2.1	0.0121	0.0167	0.0205	0.0224	0.0273	0.0367	0.0254	0.0319	0.0208	0.0180
2.3	0.0121	0.0281	0.0215	0.0278	0.0185	0.0268	0.0252	0.0299	0.0232	0.0235
2.5	0.0144	0.0287	0.0252	0.0245	0.0213	0.0366	0.0203	0.0240	0.0229	0.0242
2.7	0.0172	0.0224	0.0214	0.0223	0.0251	0.0244	0.0218	0.0237	0.0149	0.0194
2.9	0.0142	0.0130	0.0131	0.0182	0.0160	0.0187	0.0201	0.0159	0.0207	0.0196
3.1	0.0100	0.0136	0.0175	0.0170	0.0087	0.0168	0.0199	0.0222	0.0102	0.0198
3.3	0.0114	0.0134	0.0141	0.0135	0.0186	0.0166	0.0140	0.0179	0.0252	0.0193
3.5	0.0083	0.0130	0.0096	0.0117	0.0070	0.0094	0.0108	0.0148	0.0098	0.0141
3.7	0.0111	0.0116	0.0055	0.0052	0.0118	0.0110	0.0081	0.0128	0.0109	0.0088
3.9	0.0185	0.0129	0.0088	0.0069	0.0089	0.0093	0.0094	0.0116	0.0162	0.0164
4.1	0.0153	0.0122	0.0069	0.0075	0.0061	0.0070	0.0072	0.0114	0.0100	0.0094
4.3	0.0131	0.0106	0.0059	0.0077	0.0069	0.0085	0.0068	0.0087	0.0089	0.0093
4.5	0.0093	0.0100	0.0065	0.0047	0.0051	0.0080	0.0049	0.0070	0.0072	0.0119
4.7	0.0070	0.0103	0.0068	0.0071	0.0054	0.0045	0.0051	0.0072	0.0077	0.0075
4.9	0.0123	0.0109	0.0069	0.0054	0.0079	0.0055	0.0082	0.0076	0.0094	0.0140
5.1	0.0176	0.0091	0.0071	0.0062	0.0069	0.0071	0.0055	0.0075	0.0064	0.0077
5.3	0.0139	0.0067	0.0055	0.0055	0.0062	0.0063	0.0051	0.0080	0.0051	0.0095
5.5	0.0126	0.0084	0.0050	0.0045	0.0059	0.0077	0.0055	0.0060	0.0048	0.0095
5.7	0.0068	0.0065	0.0054	0.0037	0.0044	0.0054	0.0068	0.0041	0.0049	0.0053
5.9	0.0073	0.0082	0.0039	0.0032	0.0049	0.0051	0.0040	0.0046	0.0063	0.0073
6.1	0.0079	0.0070	0.0040	0.0049	0.0029	0.0043	0.0044	0.0066	0.0052	0.0057
6.3	0.0164	0.0087	0.0055	0.0042	0.0038	0.0061	0.0036	0.0054	0.0050	0.0050
6.5	0.0123	0.0084	0.0052	0.0062	0.0078	0.0077	0.0086	0.0071	0.0092	0.0074
6.7	0.0113	0.0067	0.0075	0.0044	0.0047	0.0058	0.0079	0.0054	0.0088	0.0116
6.9	0.0067	0.0058	0.0058	0.0042	0.0054	0.0034	0.0030	0.0039	0.0070	0.0080
7.1	0.0088	0.0066	0.0043	0.0019	0.0041	0.0044	0.0063	0.0076	0.0097	0.0117
7.3	0.0068	0.0059	0.0043	0.0031	0.0042	0.0038	0.0047	0.0053	0.0055	0.0055
7.5	0.0135	0.0062	0.0038	0.0032	0.0047	0.0042	0.0046	0.0031	0.0049	0.0045
7.7	0.0098	0.0049	0.0038	0.0043	0.0054	0.0044	0.0047	0.0033	0.0042	0.0070
7.9	0.0101	0.0060	0.0038	0.0034	0.0043	0.0042	0.0043	0.0037	0.0062	0.0059
8.1	0.0066	0.0061	0.0038	0.0031	0.0036	0.0041	0.0042	0.0033	0.0045	0.0048
8.3	0.0053	0.0060	0.0036	0.0032	0.0047	0.0035	0.0047	0.0042	0.0041	0.0037
8.5	0.0076	0.0047	0.0029	0.0030	0.0047	0.0053	0.0038	0.0038	0.0031	0.0037
8.7	0.0119	0.0053	0.0039	0.0037	0.0028	0.0042	0.0044	0.0030	0.0034	0.0040
8.9	0.0049	0.0071	0.0032	0.0028	0.0027	0.0044	0.0036	0.0038	0.0042	0.0046

Model: SOFAR 33000TL-G2										
Active power (Wirkleistung) $P/P_n$ [%]	10	20	30	40	50	60	70	80	90	100
Ordinal number (Ordnungszahl)	I [%]	I [%]	I [%]	I [%]	I [%]	I [%]	I [%]	I [%]	I [%]	I [%]
2	0.036	0.034	0.036	0.042	0.046	0.049	0.049	0.049	0.044	0.071
3	0.073	0.068	0.081	0.102	0.120	0.138	0.139	0.135	0.131	0.161
4	0.011	0.017	0.025	0.025	0.020	0.020	0.021	0.022	0.026	0.086
5	0.095	0.056	0.122	0.270	0.371	0.447	0.487	0.532	0.576	0.555
6	0.009	0.007	0.008	0.006	0.008	0.009	0.009	0.010	0.010	0.031
7	0.081	0.057	0.118	0.269	0.374	0.456	0.498	0.542	0.586	0.658
8	0.008	0.010	0.010	0.008	0.008	0.010	0.009	0.010	0.008	0.045
9	0.044	0.038	0.053	0.068	0.075	0.083	0.083	0.078	0.078	0.067
10	0.007	0.004	0.006	0.014	0.018	0.017	0.018	0.020	0.023	0.009
11	0.224	0.089	0.099	0.171	0.224	0.262	0.291	0.312	0.337	0.386
12	0.008	0.004	0.007	0.005	0.005	0.007	0.006	0.005	0.004	0.021
13	0.184	0.089	0.072	0.104	0.153	0.183	0.207	0.222	0.239	0.242
14	0.003	0.004	0.007	0.012	0.013	0.013	0.014	0.015	0.017	0.036
15	0.014	0.023	0.016	0.030	0.026	0.025	0.024	0.018	0.017	0.011
16	0.003	0.004	0.008	0.008	0.007	0.007	0.007	0.006	0.005	0.012
17	0.180	0.107	0.074	0.073	0.091	0.122	0.145	0.150	0.139	0.107
18	0.005	0.003	0.002	0.004	0.004	0.005	0.005	0.005	0.005	0.008
19	0.133	0.089	0.065	0.065	0.081	0.103	0.130	0.144	0.142	0.128
20	0.002	0.002	0.002	0.003	0.003	0.002	0.003	0.003	0.004	0.009
21	0.010	0.014	0.009	0.009	0.008	0.013	0.013	0.010	0.011	0.011
22	0.002	0.003	0.002	0.002	0.003	0.004	0.004	0.004	0.005	0.006
23	0.073	0.074	0.058	0.052	0.061	0.075	0.090	0.102	0.113	0.117
24	0.002	0.003	0.002	0.002	0.002	0.002	0.002	0.002	0.002	0.003
25	0.055	0.048	0.053	0.054	0.054	0.067	0.077	0.082	0.085	0.084
26	0.002	0.003	0.002	0.002	0.003	0.004	0.004	0.005	0.005	0.005
27	0.010	0.008	0.011	0.011	0.011	0.010	0.013	0.012	0.010	0.008
28	0.002	0.002	0.002	0.003	0.004	0.004	0.004	0.003	0.003	0.002
29	0.049	0.025	0.043	0.049	0.055	0.062	0.071	0.074	0.069	0.060
30	0.002	0.001	0.002	0.002	0.002	0.002	0.002	0.002	0.002	0.002
31	0.065	0.011	0.036	0.043	0.045	0.052	0.063	0.070	0.070	0.064
32	0.002	0.002	0.002	0.002	0.002	0.002	0.002	0.002	0.002	0.002
33	0.012	0.004	0.010	0.004	0.007	0.011	0.008	0.008	0.012	0.014
34	0.002	0.001	0.002	0.002	0.002	0.003	0.002	0.002	0.002	0.003
35	0.072	0.007	0.031	0.041	0.038	0.047	0.055	0.062	0.065	0.061
36	0.002	0.001	0.002	0.001	0.002	0.002	0.002	0.002	0.002	0.002
37	0.066	0.010	0.016	0.040	0.040	0.051	0.054	0.056	0.057	0.054
38	0.001	0.002	0.002	0.001	0.002	0.002	0.002	0.002	0.003	0.002
39	0.005	0.003	0.006	0.004	0.006	0.008	0.008	0.006	0.005	0.005
40	0.001	0.001	0.001	0.002	0.002	0.002	0.003	0.002	0.002	0.002

Inter-harmonics (Zwischenharmonische)										
Active power (Wirkleistung) $P/P_n$ [%]	10	20	30	40	50	60	70	80	90	100
Frequenz (Frequency) [kHz]	I [%]	I [%]	I [%]	I [%]	I [%]	I [%]	I [%]	I [%]	I [%]	I [%]
75	0.017	0.015	0.013	0.013	0.015	0.015	0.016	0.017	0.016	0.018
125	0.022	0.023	0.023	0.023	0.023	0.023	0.022	0.020	0.022	0.022
175	0.023	0.025	0.024	0.022	0.022	0.023	0.022	0.021	0.020	0.020
225	0.021	0.023	0.023	0.022	0.023	0.023	0.022	0.020	0.020	0.020
275	0.019	0.021	0.020	0.021	0.023	0.023	0.023	0.021	0.021	0.021
325	0.016	0.017	0.017	0.017	0.020	0.021	0.021	0.020	0.020	0.021
375	0.012	0.014	0.013	0.013	0.016	0.017	0.018	0.018	0.019	0.020
425	0.012	0.013	0.013	0.013	0.015	0.017	0.018	0.018	0.020	0.022
475	0.009	0.011	0.010	0.009	0.011	0.013	0.014	0.015	0.016	0.017
525	0.009	0.009	0.008	0.009	0.011	0.011	0.013	0.013	0.014	0.016
575	0.009	0.009	0.008	0.008	0.010	0.011	0.012	0.013	0.015	0.016
625	0.007	0.007	0.006	0.006	0.008	0.008	0.009	0.010	0.011	0.012
675	0.007	0.006	0.006	0.006	0.007	0.008	0.008	0.009	0.010	0.011
725	0.006	0.006	0.005	0.006	0.007	0.007	0.008	0.008	0.009	0.010
775	0.006	0.006	0.005	0.006	0.007	0.007	0.007	0.007	0.008	0.009
825	0.008	0.007	0.007	0.006	0.008	0.008	0.009	0.008	0.011	0.011
875	0.006	0.005	0.005	0.005	0.006	0.007	0.007	0.008	0.008	0.009
925	0.006	0.005	0.005	0.005	0.006	0.007	0.007	0.007	0.008	0.008
975	0.005	0.005	0.004	0.004	0.005	0.006	0.006	0.006	0.007	0.007
1025	0.005	0.004	0.004	0.004	0.005	0.005	0.006	0.006	0.007	0.007
1075	0.005	0.004	0.004	0.004	0.005	0.005	0.006	0.006	0.006	0.007
1125	0.005	0.004	0.004	0.004	0.005	0.005	0.005	0.006	0.006	0.007
1175	0.004	0.004	0.004	0.004	0.005	0.005	0.005	0.006	0.005	0.006
1225	0.004	0.005	0.004	0.004	0.006	0.007	0.007	0.007	0.007	0.008
1275	0.005	0.004	0.005	0.005	0.006	0.007	0.008	0.009	0.012	0.016
1325	0.004	0.004	0.004	0.004	0.005	0.005	0.006	0.007	0.009	0.012
1375	0.004	0.004	0.004	0.004	0.005	0.005	0.007	0.009	0.011	0.015
1425	0.004	0.004	0.004	0.004	0.005	0.005	0.006	0.006	0.006	0.008
1475	0.004	0.003	0.003	0.003	0.004	0.004	0.004	0.005	0.005	0.006
1525	0.004	0.003	0.003	0.003	0.004	0.004	0.004	0.004	0.005	0.005
1575	0.004	0.003	0.003	0.004	0.004	0.004	0.005	0.005	0.005	0.006
1625	0.004	0.003	0.003	0.003	0.004	0.004	0.004	0.004	0.005	0.005
1675	0.004	0.003	0.003	0.004	0.004	0.004	0.004	0.004	0.005	0.005
1725	0.004	0.003	0.003	0.003	0.004	0.004	0.004	0.004	0.005	0.005
1775	0.004	0.003	0.003	0.003	0.004	0.004	0.004	0.004	0.005	0.004
1825	0.003	0.003	0.003	0.003	0.004	0.004	0.004	0.004	0.004	0.004
1875	0.003	0.003	0.003	0.003	0.003	0.004	0.004	0.004	0.004	0.004
1925	0.003	0.003	0.003	0.003	0.004	0.004	0.004	0.004	0.004	0.004
1975	0.003	0.003	0.003	0.003	0.003	0.004	0.004	0.003	0.004	0.004

Higher frequencies (Höhere Frequenzen)										
Active power (Wirkleistung) $P/P_n$ [%]	10	20	30	40	50	60	70	80	90	100
Frequenz (Frequency) [kHz]	I [%]	I [%]	I [%]	I [%]	I [%]	I [%]	I [%]	I [%]	I [%]	I [%]
2.1	0.003	0.002	0.002	0.002	0.003	0.002	0.003	0.002	0.003	0.003
2.3	0.011	0.011	0.011	0.011	0.011	0.011	0.011	0.011	0.012	0.012
2.5	0.003	0.003	0.003	0.003	0.004	0.004	0.004	0.004	0.005	0.005
2.7	0.003	0.002	0.002	0.002	0.003	0.003	0.003	0.002	0.003	0.003
2.9	0.003	0.003	0.003	0.003	0.003	0.004	0.004	0.003	0.003	0.003
3.1	0.003	0.003	0.003	0.004	0.005	0.004	0.004	0.003	0.004	0.003
3.3	0.006	0.006	0.006	0.006	0.006	0.006	0.006	0.005	0.005	0.004
3.5	0.006	0.006	0.008	0.008	0.008	0.008	0.007	0.006	0.005	0.005
3.7	0.006	0.007	0.008	0.008	0.010	0.010	0.008	0.007	0.006	0.006
3.9	0.012	0.013	0.014	0.014	0.016	0.017	0.018	0.018	0.020	0.021
4.1	0.012	0.012	0.012	0.013	0.014	0.014	0.015	0.017	0.018	0.019
4.3	0.004	0.003	0.003	0.003	0.004	0.004	0.004	0.004	0.004	0.004
4.5	0.003	0.003	0.003	0.003	0.003	0.003	0.003	0.003	0.004	0.003
4.7	0.003	0.002	0.002	0.002	0.003	0.002	0.003	0.002	0.003	0.003
4.9	0.002	0.002	0.002	0.002	0.002	0.002	0.002	0.002	0.003	0.002
5.1	0.002	0.002	0.002	0.002	0.002	0.002	0.002	0.002	0.002	0.002
5.3	0.002	0.002	0.002	0.002	0.002	0.002	0.002	0.002	0.002	0.002
5.5	0.002	0.002	0.002	0.002	0.002	0.002	0.002	0.002	0.002	0.002
5.7	0.001	0.002	0.002	0.002	0.002	0.002	0.001	0.002	0.002	0.002
5.9	0.001	0.002	0.002	0.002	0.002	0.002	0.001	0.002	0.002	0.002
6.1	0.001	0.001	0.002	0.002	0.002	0.001	0.001	0.002	0.002	0.002
6.3	0.001	0.001	0.002	0.001	0.002	0.001	0.001	0.002	0.002	0.001
6.5	0.001	0.001	0.002	0.001	0.002	0.001	0.001	0.002	0.002	0.001
6.7	0.001	0.001	0.001	0.001	0.001	0.001	0.001	0.002	0.002	0.001
6.9	0.001	0.001	0.002	0.001	0.001	0.001	0.001	0.002	0.002	0.002
7.1	0.001	0.001	0.002	0.002	0.002	0.001	0.001	0.002	0.002	0.002
7.3	0.001	0.001	0.001	0.001	0.001	0.001	0.001	0.002	0.001	0.001
7.5	0.001	0.001	0.001	0.001	0.001	0.001	0.001	0.001	0.001	0.001
7.7	0.001	0.001	0.001	0.001	0.001	0.001	0.001	0.001	0.001	0.001
7.9	0.001	0.001	0.001	0.001	0.002	0.001	0.001	0.002	0.002	0.002
8.1	0.002	0.002	0.002	0.002	0.002	0.002	0.002	0.002	0.002	0.002
8.3	0.001	0.001	0.001	0.001	0.001	0.001	0.001	0.001	0.001	0.001
8.5	0.001	0.001	0.001	0.001	0.001	0.001	0.001	0.001	0.001	0.001
8.7	0.001	0.001	0.001	0.001	0.001	0.001	0.001	0.001	0.001	0.001
8.9	0.001	0.001	0.001	0.001	0.001	0.001	0.001	0.001	0.001	0.001

**E.5 Requirements for the test report for the NS protection**

Requirements for the NS protection (Anforderungen an den NA-Schutz)						
Extract of the test report for NS protection (Auszug aus dem Prüfbericht für den NA-Schutz)						
NS protection as integrated NS protection (NA-Schutz als integrierter)						
Manufacturer: (Hersteller)	<b>Shenzhen SOFAR SOLAR Co., Ltd.</b> 401, Building 4, AnTongDa Industrial Park, District 68, XingDong Community, XinAn Street, BaoAn District, Shenzhen, China					
Type of NS Protection: (Typ NA-Schutz)	<b>Integrierter NA-Schutz</b>					
Software Version:	<b>V2.30</b>					
Measurement Period: (Messzeitraum)	2020-03-09 bis 2020-06-10					
	Stirling generators, fuel cells ( Stirlinggeneratoren, Brennstoffzellen )			Inverter(s) ( Umrichter )		
	Synchronous and asynchronous generators with $P_n \leq 50$ kW coupled directly or via inverters ( direkt oder über Umrichter gekoppelte Synchron- und Asynchrongeneratoren mit $P_n \leq 50$ kW )			Directly coupled synchronous and asynchronous generators with $P_n > 50$ kW ( direkt gekoppelte Synchron- und Asynchrongeneratoren mit $P_n > 50$ kW )		
Protective function ( Schutzfunktion )	Set value ( Einstellwert )	Tripping value ( Auslösewert )	Tripping time NS protection * ( Auslösezeit NA-Schutz* )	Set value ( Einstellwert )	Tripping value ( Auslösewert )	Tripping time NS protection * ( Auslösezeit NA- Schutz* )
Rise-in-voltage protection (Spannungssteigerungsschutz) $U >>$	--	--	--	$1,25 * U_n$	$1.252* U_n$	93.0ms
Rise-in-voltage protection (Spannungssteigerungsschutz) $U >$	--	--	--	$1,10 * U_n$	$1.10* U_n$	530s
Voltage drop protection (Spannungsrückgangsschutz) $U <$	--	--	--	$0,8 * U_n$	$0.796* U_n$	3.05s
Voltage drop protection (Spannungsrückgangsschutz) $U <<$		--		$0,45* U_n$	$0.448* U_n$	334ms
Frequency decrease protection (Frequenzrückgangsschutz) $f <$	--	--	--	47,5 Hz	47.49Hz	99.8ms
Frequency increase protection (Frequenzsteigerungsschutz) $f >$	--	--	--	51,5 Hz	51.51Hz	83.0ms

<p>* The tripping time includes the period from the limit value violation <math>U/f</math> until the tripping signal to the interface switch.          When planning the power generation system, the response time of the interface switch shall be added to the maximum time value obtained as indicated above.          The disconnection time (sum of tripping time of the NS protection plus response time of the interface switch) shall not exceed 200 ms.          * Die Auslösezeit umfasst den Zeitraum von der Grenzwertverletzung <math>U/f</math> bis zum Auslösesignal an den Kuppelschalter.          Bei der Planung der Erzeugungsanlage ist die Eigenzeit des Kuppelschalters zum höchsten oben ermittelten Zeitwert zu addieren.          Die Abschaltzeit (Summe der Auslösezeit NA-Schutz zzgl. Eigenzeit des Kuppelschalters) darf 200 ms nicht überschreiten.</p>	
<input checked="" type="checkbox"/> For integrated NS protection (Bei integriertem NA-Schutz)	
Assigned to power generation unit of type zugeordnet zu Erzeugungseinheit Typ	<b>SOFAR 20000TL-G2, SOFAR 25000TL-G2</b>
Type integrated interface switch Typ integrierter Kuppelschalter	<b>T9VV1K15-12S</b>
Response time of interface switch for integrated NS protection Eigenzeit des Kuppelschalters bei integriertem NA-Schutz	<b>20ms</b>
<p>Verification of the entire functional chain "integrated NS protection – interface switch" has resulted in successful disconnection.          Die Überprüfung der Gesamtwirkungskette „integrierter NA-Schutz – Kuppelschalter“ führte zu einer erfolgreichen Abschaltung.</p>	

Appended photos

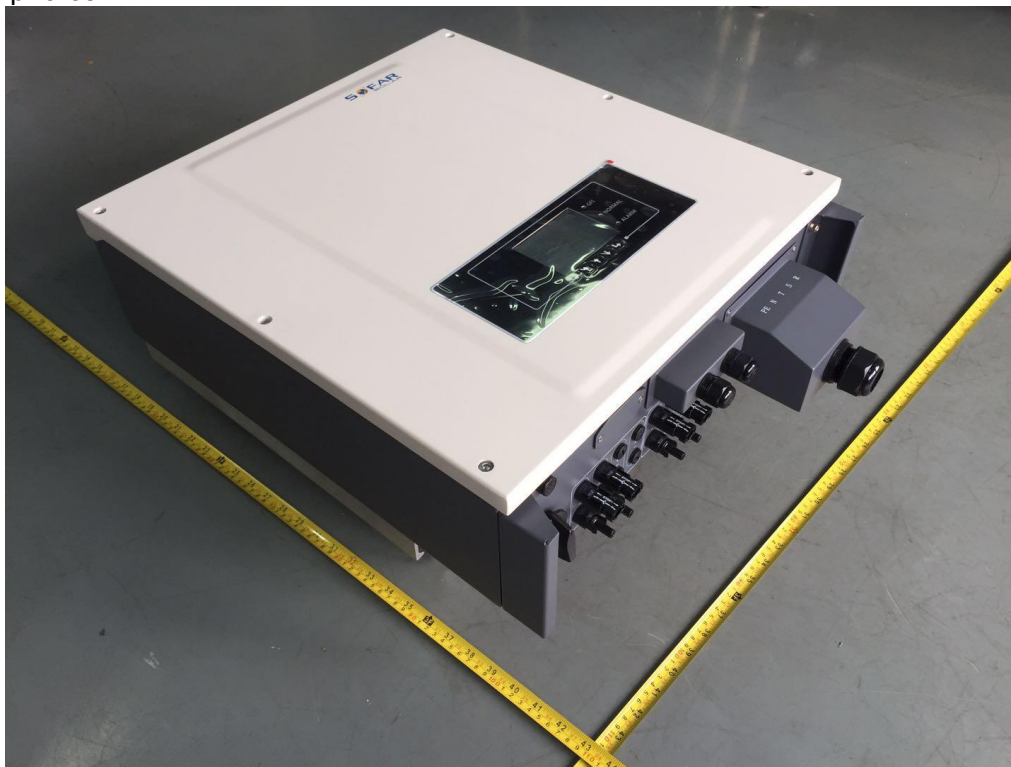

Front view of model SOFAR 20000TL

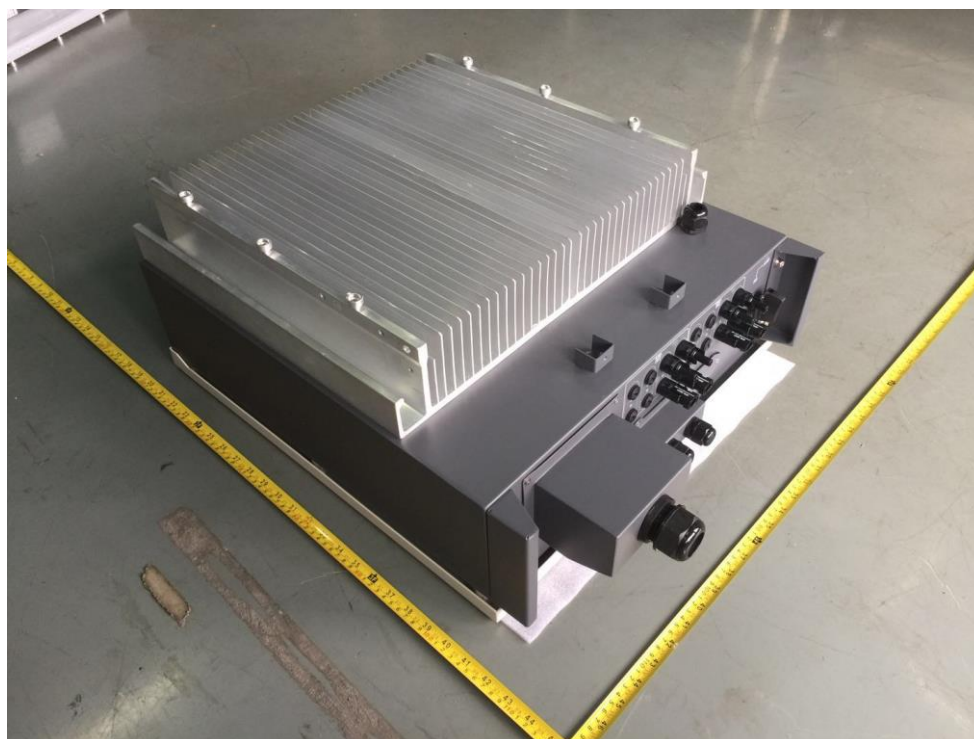

Rear view of model SOFAR 20000TL

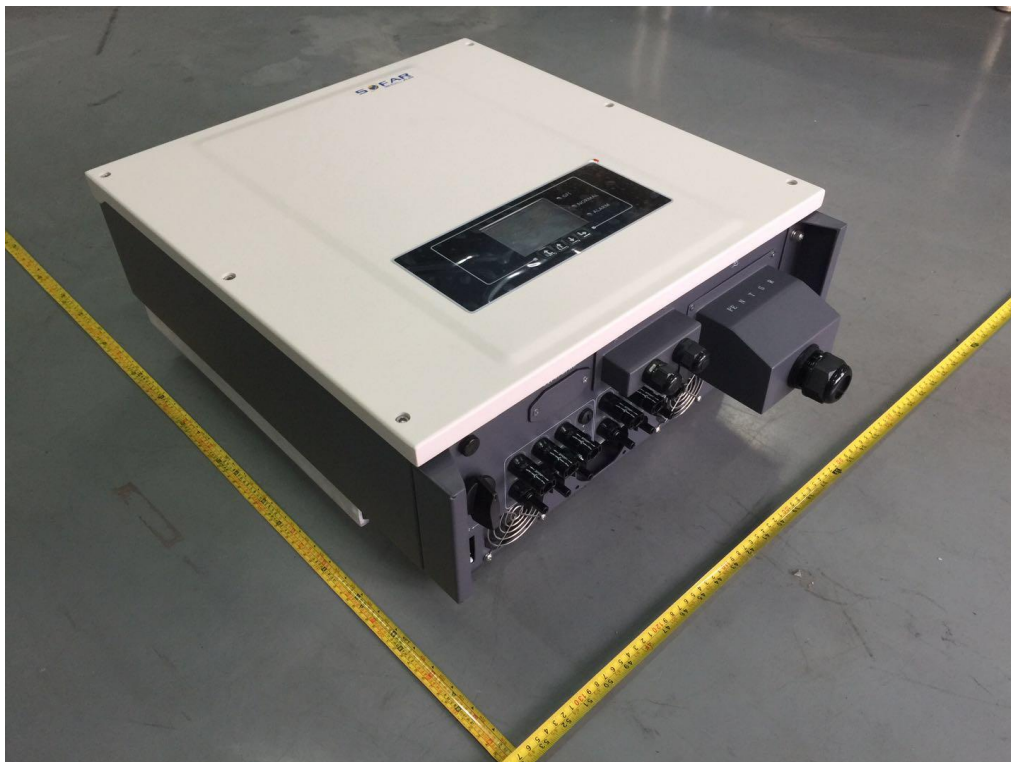

Front view of model SOFAR 25000TL



Rear view of model SOFAR 25000TL





Front view of model SOFAR 30000TL, SOFAR 33000TL

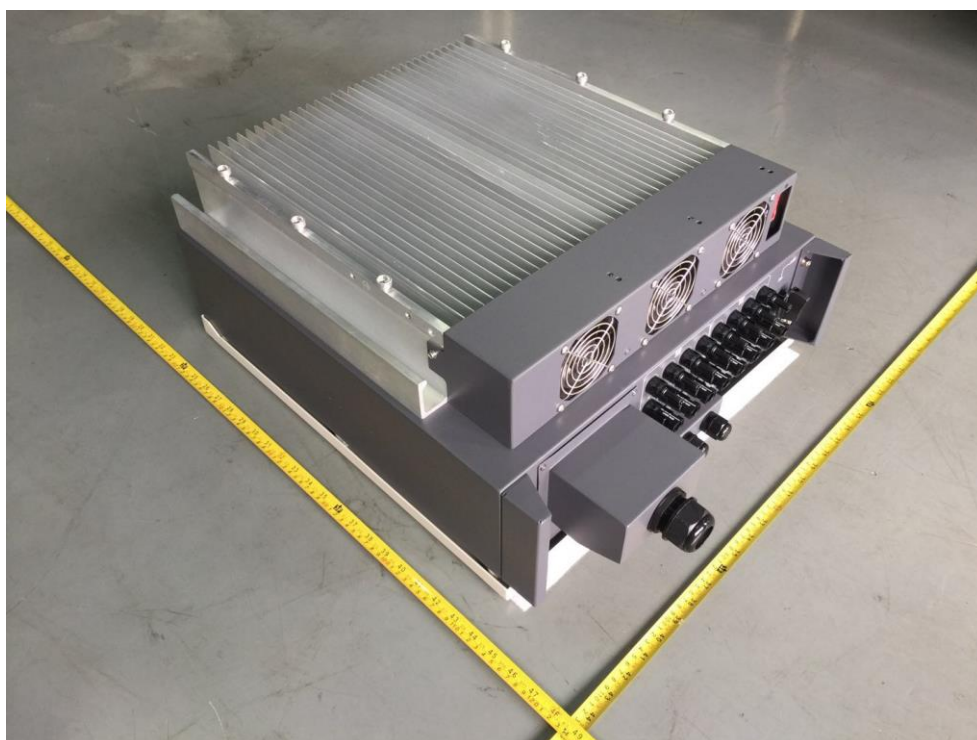

Rear view of model SOFAR 30000TL, SOFAR 33000TL



Internal view of SOFAR 20000TL



Internal view of SOFAR 25000TL

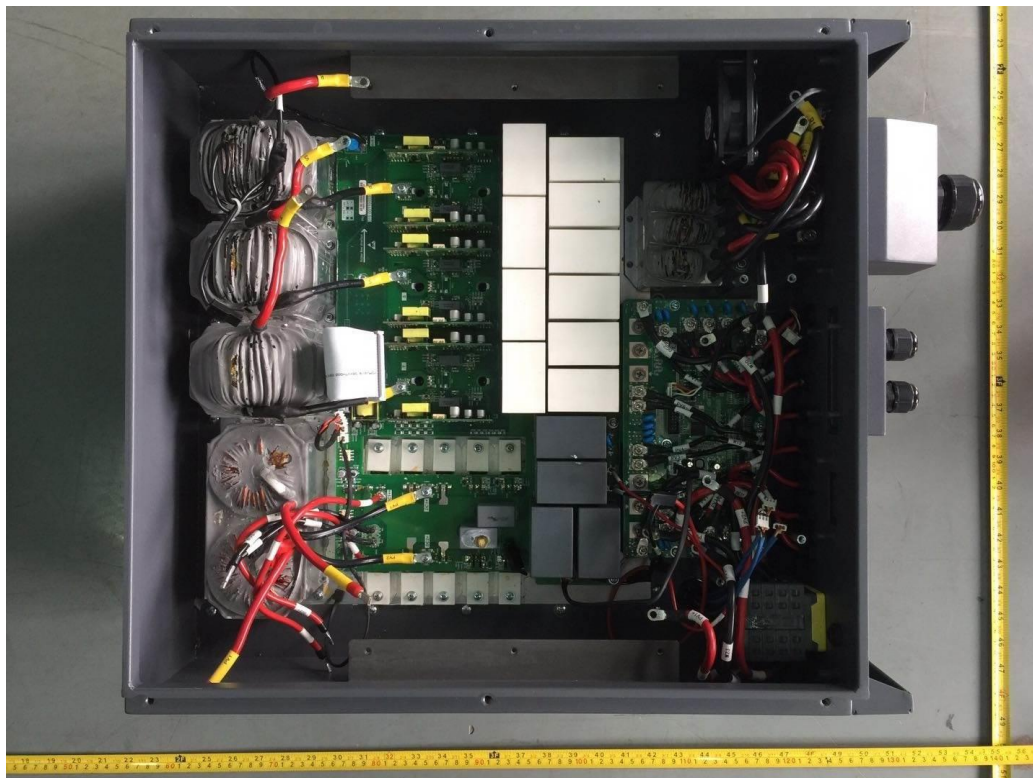

Internal view of SOFAR 30000TL, SOFAR 33000TL

(End of Report)